

Features

- Transmit/Receive Loop Antenna Set for MIL-STD-461, RS101 Calibration/Test
- Frequency Range: 30 Hz to 100 kHz
- Convenient, Fixed Mounting Arrangement for Receive Loop onto Transmit Loop for Accurate Calibration of Test Levels
- Three-year Standard Warranty

Description

The **AL-RS101-TX** is a transmitting loop antenna constructed with 20 turns of 12 gauge enamel-insulated copper wire with a mean diameter of 12 cm. The Teflon (PTFE) structure onto which the wire is wound is elongated in order to provide the required 5 cm spacing between the loop coils and the Equipment Under Test (EUT) when the antenna is placed flush against the EUT surface as shown to the left.

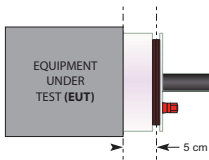

The antenna input terminals are fitted with 4 mm banana jacks.

The **AL-RS101-TX** also incorporates a mechanism for mounting the **AL-RS101-RX** antenna into the exact required position for calibration of test levels, with the required 5 cm spacing between the loops.

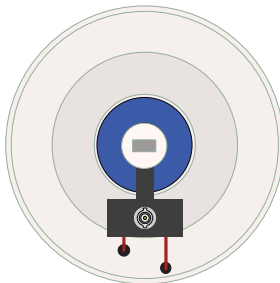

The antenna is capable of handling RF currents as high as 15 amperes; corresponding to a maximum magnetic flux density of 1.42×10^9 pico Tesla or 183.1 dBpT; [9.49×10^7 pT/Ampere] at a distance of 5 cm.

The **AL-RS101-RX** is a receiving loop antenna used during RS101 test level calibration to measure the magnetic field intensity generated by the **AL-RS101-TX** transmit loop. Its construction consists of a 51-turn, electrostatically shielded coil of 7-strand, 41 gauge Litz wire. The antenna output port is fitted with a female BNC connector.

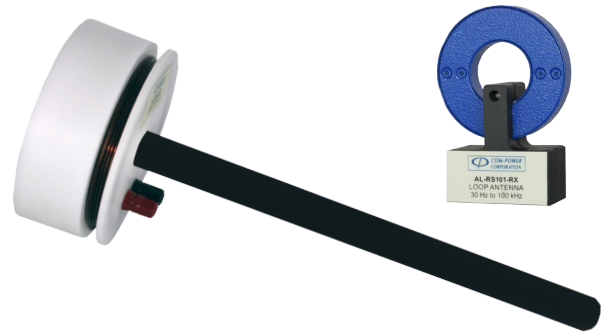

Application

The RS101 Loop Antenna Set is specifically designed for tests according to MIL-STD-461, RS101, radiated susceptibility, magnetic field. During this test, the Equipment Under Test (EUT) is exposed to magnetic fields of a specified magnitude to ensure that it does not exhibit any malfunction, degradation of performance, or deviation from specified indications.

Prior to the test, the field generated is calibrated by measuring the field with the **AL-RS101-RX** antenna, which is aligned coaxially with the **AL-RS101-TX** transmit loop with a separation distance of 5 cm. The RF current delivered to the transmit loop is monitored and then recorded when the required field is achieved at each test frequency.

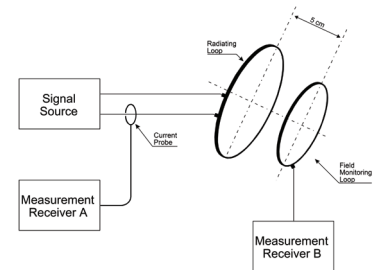

When the test is performed, the amplitude of the test generator is increased until the current value measured with the current probe is equal to the value recorded during calibration, at each respective test frequency.

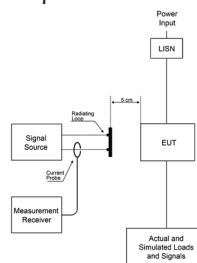

Calibration

The antenna is individually calibrated using NIST Traceable equipment per SAE ARP-958 and MIL-STD-461. The calibration data, along with certificate, are provided. Recognized ISO 17025 accredited calibration is also available upon request.

Specifications

Model	AL-RS101-TX	AL-RS101-RX
Frequency Range	30 Hz to 100 kHz	30 Hz to 100 kHz
Loop Diameter	12 cm	4 cm
Number of Turns	20 Turns	51 Turns
Wire Type	12 AWG (enamel insulated)	7 Strand, 41 AWG Litz
Loop Shielding	N/A	Electrostatic Shield
Resistance of Wiring	40 mΩ	4Ω
Inductance of Wiring	90 μH	180 μH
Maximum Input Current	15 Amps (continuous)	N/A
Connectors	(2) Banana Jacks	BNC (female)
Specifications	MIL-STD-461, RS101	MIL-STD-461, RS101
Weight	2.2 lbs. [1 kg]	0.26 lbs. [0.12 kg]

All values are typical, unless specified.
 All specifications are subject to change without notice.

Related Products Available from Com-Power:



AL-RE101 Loop Antenna



LI-400 50 μH Line Impedance Stabilization Network (LISN)

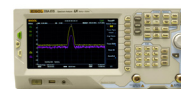

SPA-815TGE Spectrum Analyzer

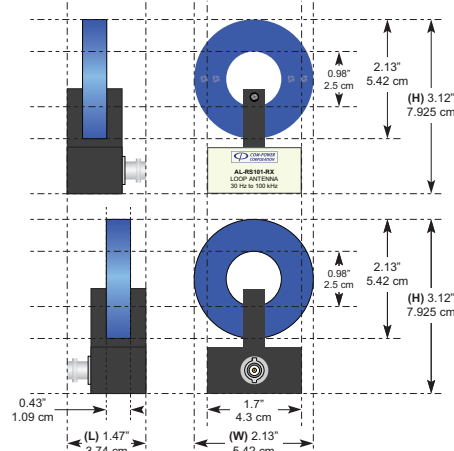
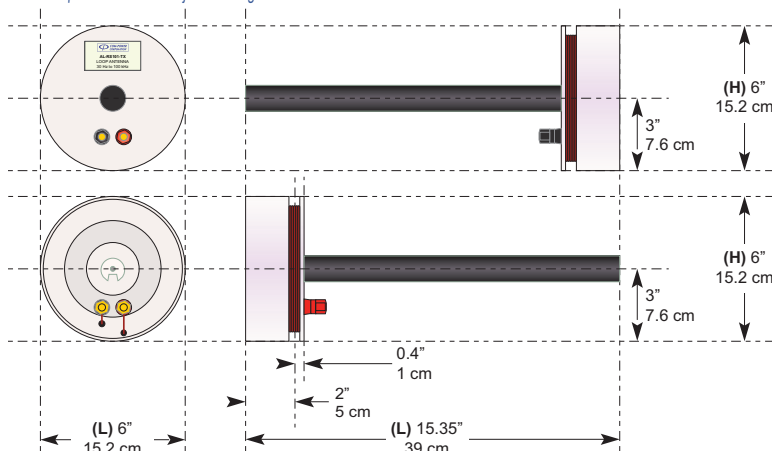

Typical Conversion Factors for AL-RS101-RX Loop Antenna

