

INSTRUCTION MANUAL

**453A/R453A
OSCILLOSCOPE**



MANUFACTURERS OF CATHODE-RAY OSCILLOSCOPES

INSTRUCTION MANUAL

Serial Number _____

453A/R453A OSCILLOSCOPE



WARRANTY

All Tektronix instruments are warranted against defective materials and workmanship for one year.

Any questions with respect to the warranty, mentioned above, should be taken up with your Tektronix Field Engineer or representative.

All requests for repairs and replacement parts should be directed to the Tektronix Field Office or representative in your area. This procedure will assure you the fastest possible service. Please include the instrument Type (or Part Number) and Serial or Model Number with all requests for parts or service.

Specifications and price change privileges reserved.

Copyright © 1971 by Tektronix, Inc., Beaverton, Oregon. Printed in the United States of America. All rights reserved. Contents of this publication may not be reproduced in any form without permission of the copyright owner.

U.S.A. and foreign Tektronix products covered by U.S. and foreign patents and/or patents pending.

TABLE OF CONTENTS

SECTION 1 453A/R453A SPECIFICATIONS	Page	SECTION 2 OPERATING INSTRUCTIONS (cont)	
Introduction	1-1	Input Coupling	2-17
Table 1-1 Electrical	1-1	Deflection Factor	2-17
Vertical Deflection System	1-1	Dual-Trace Operation	2-17
Triggering (A and B Sweep)	1-3	Channel 1 Output and Cascaded Operation	2-18
Horizontal Deflection System	1-4	Algebraic Addition	2-19
Calibrator	1-6	Trigger Source	2-19
Z Axis Input	1-7	Trigger Coupling	2-20
Output Signals	1-7	Trigger Slope	2-21
Display	1-8	Trigger Level	2-21
Power Supply	1-8	High-Frequency Stability	2-21
Table 1-2 Environmental Characteristics	1-9	A Sweep Triggered Light	2-21
Table 1-3 Physical	1-9	A Sweep Mode	2-21
Standard Accessories	1-10	Horizontal Sweep Rate	2-23
		Sweep Magnification	2-23
		Mixed and Delayed Sweep	2-24
		X-Y Operation	2-27
		A and B Gate	2-27
		Intensity Modulation	2-27
		Calibrator	2-27
		Applications	
		General	2-20
		Peak to Peak Voltage Measurements—AC	2-28
		Instantaneous Voltage Measurements—DC	2-29
		Comparison Measurements	2-30
		Time-Duration Measurements	2-31
		Determining Frequency	2-32
		Risetime Measurements	2-32
		Time-Difference Measurements	2-33
		Delayed Sweep Time Measurements	2-34
		Delayed Sweep Magnification	2-35
		Displayed Complex Signals Using Delayed Sweep	2-36
		Pulse Jitter Measurements	2-37
		Delayed Trigger Generator	2-38
		Normal Trigger Generator	2-39
		Multi-Trace Phase Difference Measurements	2-39
		High Resolution Phase Measurements	2-40
		X-Y Phase Measurements	2-40
		Common-Mode Rejection	2-42
SECTION 2 OPERATING INSTRUCTIONS			
General	2-1		
Front Cover	2-1		
Operating Voltage	2-1		
Operating Temperature	2-2		
Operating Position	2-2		
Rackmounting	2-2		
Controls and Connectors	2-3		
First-Time Operation	2-7		
Test Set-up Chart	2-11		
General Operating Information			
Simplified Operating Information	2-11		
Intensity Control	2-14		
Astigmatism Adjustment	2-14		
Graticule	2-14		
Trace Alignment Adjustment	2-15		
Light Filter	2-15		
Beam Finder	2-15		
Vertical Channel Selection	2-15		
Vertical Gain Adjustment	2-15		
Step Attenuator Balance	2-16		
Signal Connections	2-16		
Loading Effect of the Type 453A/R453A	2-16		
Coaxial Cable Considerations	2-16		
Ground Considerations	2-17		

CONTENTS (cont)

SECTION 3 CIRCUIT DESCRIPTION

Introduction	3-1
Block Diagram	3-1
Circuit Operation	3-3
Channel 1 Vertical Preamp	3-4
Channel 2 Vertical Preamp	3-6
Vertical Switching	3-7
Vertical Output Amplifier	3-9
Trigger Preamp	3-10
A Trigger Generator	3-12
A Sweep Generator	3-16
B Trigger Generator	3-19
B Sweep Generator	3-21
Horizontal Amplifier	3-23
Z Axis Amplifier	3-25
CRT Circuit	3-27
Low-Voltage Power Supply	3-28
Voltage Distribution	3-31
Calibrator	3-31

SECTION 4 MAINTENANCE

Introduction	4-1
Cover Removal	4-1
Preventive Maintenance	
General	4-1
Cleaning	4-1
Lubrication	4-2
Visual Inspection	4-2
Transistor Checks	4-2
Recalibration	4-2
Troubleshooting	
Introduction	4-2
Troubleshooting Aids	4-2
Troubleshooting Equipment	4-4
Troubleshooting Techniques	4-4
Corrective Maintenance	
General	4-7
Obtaining Replacement Parts	4-7
Soldering Techniques	4-7
Component Replacement	4-10
Recalibration After Repair	4-13
Instrument Repackaging	4-13

SECTION 5 CALIBRATION

Introduction	5-1
Tektronix Field Service	5-1
Using This Procedure	5-1
Test Equipment Required	5-1
Preliminary Control Settings	5-3
Part I—Performance Check	
Introduction	5-4
Index to Part I—Performance Check	5-4
Preliminary Procedure for Performance Check	
	5-5
Part II—Adjustment	
Introduction	5-26
Index to Part II—Adjustment	5-26
Preliminary Procedure for Adjustment	
	5-26

SECTION 6 RACKMOUNTING

Introduction	6-1
Instrument Dimensions	6-1
Rack Dimensions	6-1
Slide-Out Tracks	6-1
Mounting Procedure	6-1
Alternative Rear Mounting Methods	6-2
Removing or Installing the Instrument	6-3
Slide-Out Track Lubrication	6-3

SECTION 7 ELECTRICAL PARTS LIST

Abbreviations and Symbols	
Parts Ordering Information	
Index of Electrical Parts List	
Electrical Parts List	

SECTION 8 DIAGRAMS AND CIRCUIT BOARD ILLUSTRATIONS

Symbols and Reference Designators	8-1
Voltage and Waveform Test Conditions	8-2
Diagrams	
Circuit Board Illustrations	

CONTENTS (cont)

SECTION 9 MECHANICAL PARTS LIST

Mechanical Parts List Information

Index of Mechanical Parts List
and Illustrations

Mechanical Parts List

CHANGE INFORMATION

Abbreviations and symbols used in this manual are based on or taken directly from IEEE Standard 260 "Standard Symbols for Units", MIL-STD-12B and other standards of the electronics industry. Change information, if any, is located at the rear of this manual.

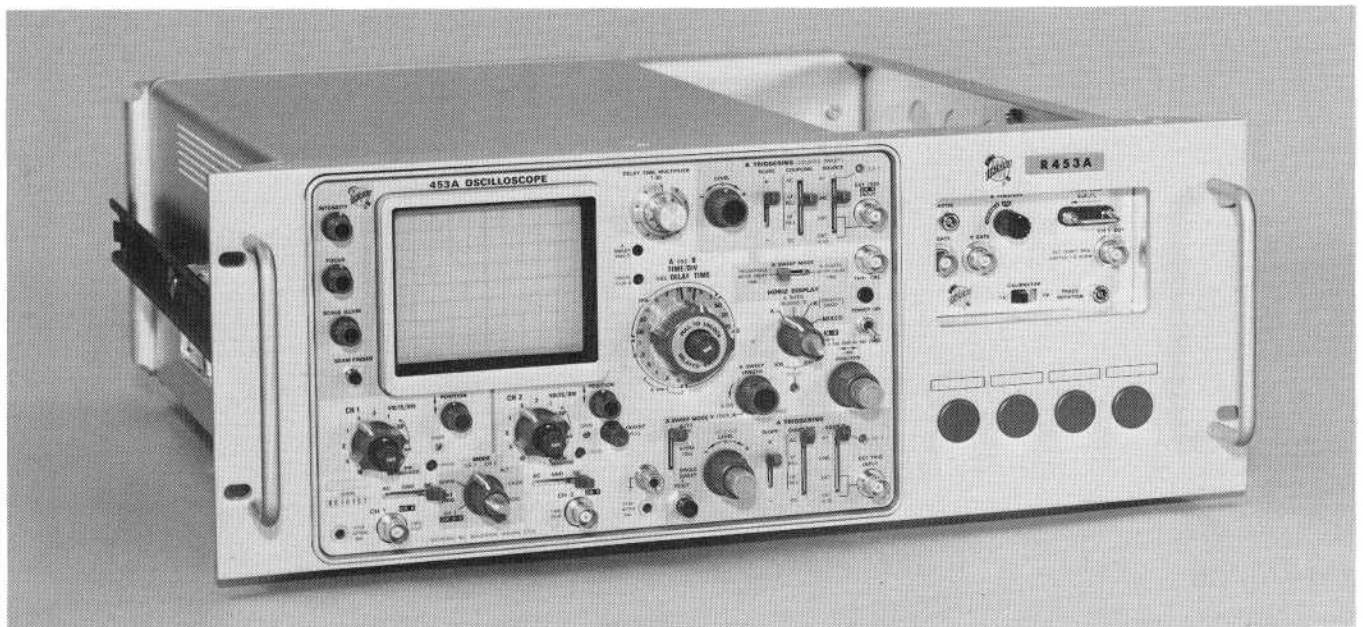
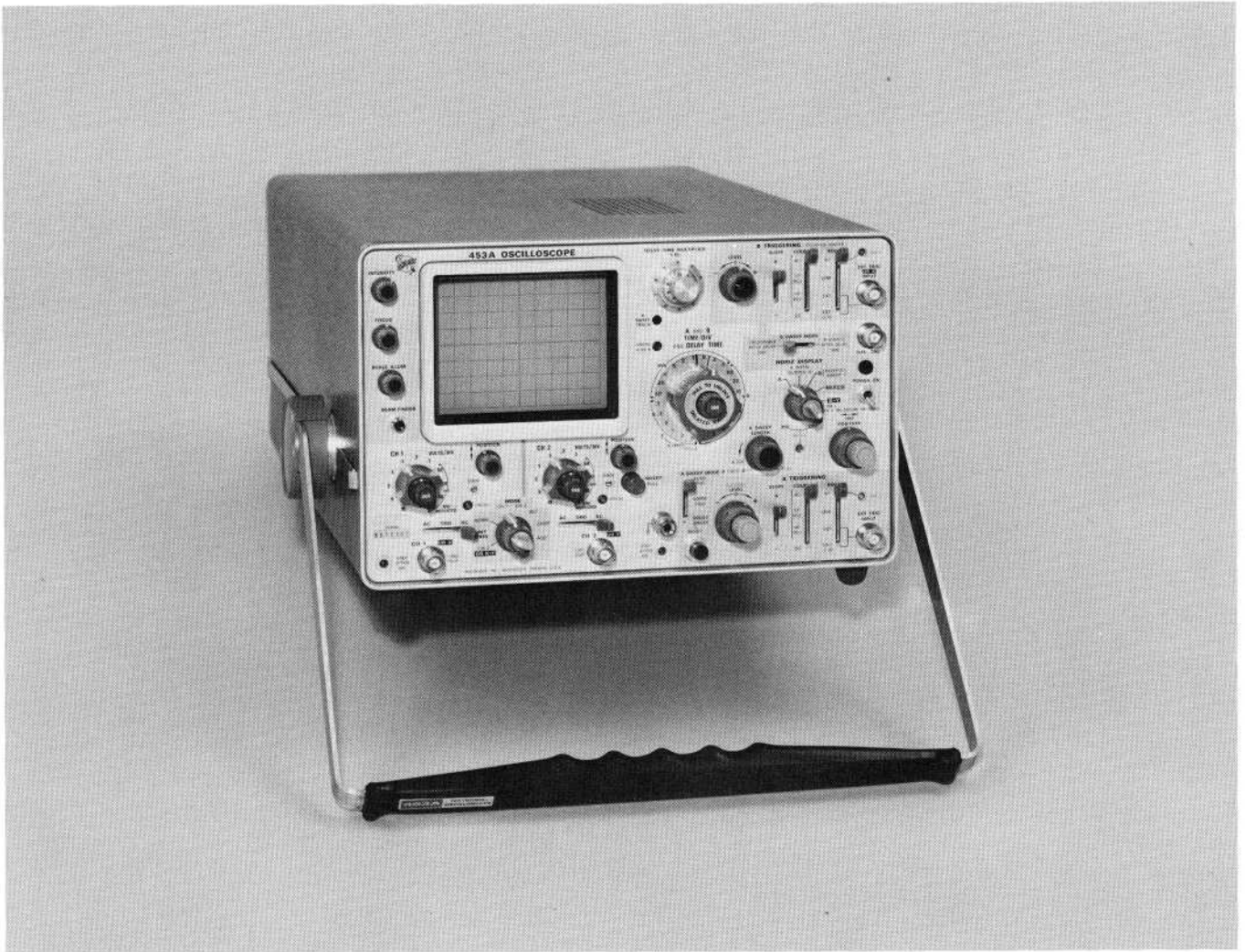


Fig. 1-1. Top; the 453A Oscilloscope. Bottom; the R453A Oscilloscope.

SECTION 1

453A/R453A SPECIFICATION

Change information, if any, affecting this section will be found at the rear of this manual.

Introduction

The Tektronix 453A Oscilloscope is a transistorized portable oscilloscope designed to operate in a wide range of environmental conditions. The light weight of the 453A allows it to be easily transported, while providing the performance necessary for accurate high-frequency measurements. The dual-channel DC-to-60 MHz vertical system provides calibrated deflection factors from 5 millivolts to 10 volts/division. Channels 1 and 2 can be cascaded using an external cable to provide a one millivolt minimum deflection factor (both VOLTS/DIV switches set to 5 mV).

The trigger circuits provide stable triggering over the full range of vertical frequency response. Separate trigger controls are provided to select the desired triggering for the A and B sweeps. One of three sweep modes can be selected for the A sweep; automatic, normal, or single sweep. The horizontal sweep provides a maximum sweep rate of 0.1 microsecond/division (10 nanoseconds/division using 10X magnifier) along with a delayed sweep feature for accurate relative-time measurements. Accurate X-Y measurements can be made with Channel 2 providing the vertical deflection, and Channel 1 providing the horizontal deflection (INT TRIG switch set to CH 1 OR X-Y, HORIZ DISPLAY

switch set to X-Y). The regulated DC power supplies maintain constant output over a wide variation of line voltages and frequencies. Total power consumption of the instrument is approximately 90 watts.

Information given in this instruction manual applies to the R453A also unless otherwise noted. The R453A is electrically identical to the 453A, but is mechanically adapted for mounting in a standard 19-inch rack. Rack-mounting instructions and a dimensional drawing for the R453A are provided in Section 6 of this manual.

This instrument will meet the electrical characteristics listed in Table 1-1 following complete calibration as given in Section 5. The performance check procedure in Section 5 provides a convenient method of checking instrument performance without making internal checks or adjustments. The following electrical characteristics apply over a calibration interval of 1000 hours and an ambient temperature range of 0°C to +50°C, except as otherwise indicated. Warmup time for given accuracy is 20 minutes.

TABLE 1-1
ELECTRICAL

Characteristic	Performance Requirement	Supplemental Information
VERTICAL DEFLECTION SYSTEM		
Deflection Factor	5 millivolts/division to 10 volts/division in 11 calibrated steps for each channel. Less than one millivolt/division when Channel 1 and 2 are cascaded.	Selected by VOLTS/DIV switch. Steps in 1-2-5 sequence.
Deflection Accuracy	Within 3% of indicated deflection. Cascaded deflection factor uncalibrated.	With GAIN correctly adjusted at 20 mV and VAR VOLTS/DIV control set to calibrated.
Variable Deflection Factor	Continuously variable between calibrated settings.	Extends maximum deflection factor to at least 25 volts/division.

TABLE 1-1 (cont)

Characteristic	Performance Requirement	Supplemental Information
Bandwidth at -3 dB points (with or without P6061 Probe)		Driven from 25-ohm source. VAR VOLTS/DIV control set to calibrated position.
20 mV to 10 VOLTS/DIV	DC to at least 60 megahertz	
10 mV/DIV	DC to at least 50 megahertz	
5 mV/DIV	DC to at least 40 megahertz	
Channels 1 and 2 cascaded	DC to at least 25 megahertz	
AC Low-Frequency Response (lower -3 dB point)		Input Coupling switch set to AC.
Without probe	1.6 hertz or less at all deflection factors.	
With P6061 Probe	0.16 hertz or less at all deflection factors.	
Input RC Characteristics		
Resistance		One megohm $\pm 2\%$
Capacitance		Approximately 20 picofarads
Maximum Safe Input Voltage		600 volts DC + peak AC (one kilohertz or less).
Input Coupling Modes	AC or DC.	Selected by Input Coupling switch.
Vertical Display Modes	Channel 1 only. Channel 2 only. Dual-trace, alternate between channels. Dual-trace, chopped between channels. Added algebraically.	
Chopped Repetition Rate	Approximately 500 kilohertz.	
Amplifier Crosstalk	100:1 or greater, DC to 20 megahertz.	
Common Mode Rejection Ratio (all deflection factors)	At least 20:1 DC to one kilohertz for signals less than eight times the VOLTS/DIV switch setting.	
Polarity Inversion	Displayed signal from Channel 2 can be inverted.	
Signal Delay Line	Permits viewing of leading edge of triggering signal (internal triggering only).	

TABLE 1-1 (cont)

Characteristic	Performance Requirement	Supplemental Information
TRIGGERING (A AND B SWEEP)		
Source	Internal from displayed channel or from Channel 1 only. Internal from AC power source. External. External divide by 10.	Selected by SOURCE switch.
Coupling	AC AC low-frequency reject AC high-frequency reject DC	Selected by COUPLING switch.
Polarity	Sweep can be triggered from positive-going or negative-going portion of trigger signal.	Selected by SLOPE switch
Internal Trigger Sensitivity		
AC	0.3 division of deflection, minimum, 30 hertz to 10 megahertz; increasing to 1.5 division at 60 megahertz.	
LF REJ	0.3 division of deflection, minimum, 30 kilohertz to 10 megahertz; increasing to 1.5 division at 60 megahertz.	
HF REJ	0.3 division of deflection, minimum, 30 hertz to 50 kilohertz.	
DC	0.3 division of deflection, minimum, DC to 10 megahertz; increasing to 1.5 division at 60 megahertz.	
External Trigger Sensitivity		
AC	50 millivolts, minimum, 30 hertz to 10 megahertz; increasing to 200 millivolts at 60 megahertz.	SOURCE switch set to EXT. Triggering signal requirements increased 10 times for EXT ÷ 10 position.
LF REJ	50 millivolts, minimum, 30 kilohertz to 10 megahertz; increasing to 200 millivolts at 60 megahertz.	
HF REJ	50 millivolts, minimum, 30 hertz to 50 kilohertz.	
DC	50 millivolts, minimum, DC to 10 megahertz; increasing to 200 millivolts at 60 megahertz.	

TABLE 1-1 (cont)

Characteristic	Performance Requirement	Supplemental Information
Auto Triggering (A sweep only)	Stable display presented with signal amplitudes given under Internal and External Trigger Sensitivity above 20 hertz. Presents a free-running sweep for lower frequencies or in absence of trigger signal.	
Single Sweep (A Sweep only)	A Sweep Generator produces only one sweep when triggered. Further sweeps are locked out until RESET button is pressed. Trigger sensitivity same as given for internal and external sensitivity.	
Display Jitter	One nanosecond or less at 10 nanoseconds/division sweep rate (MAG switch set to X10).	
External Trigger Input RC Characteristics		One megohm paralleled by 20 picofarads (approximate).
LEVEL control range EXT		At least + and - 2 volts.
EXT ÷ 10		At least + and - 20 volts.
Maximum safe input voltage		600 volts DC + peak AC (one kilohertz or less)

HORIZONTAL DEFLECTION SYSTEM

A and B Sweep Generator

Sweep Rates				
A sweep (delaying sweep)	0.1 microsecond/division to 5 seconds/division in 24 calibrated steps.		Selected by A TIME/DIV switch. Steps in 1-2-5 sequence.	
B sweep (delayed sweep)	0.1 microsecond/division to 0.5 second/division in 21 calibrated steps		Selected by B TIME/DIV switch. Steps in 1-2-5 sequence.	
Sweep Accuracy	Performance Requirement			
	0°C to +40°C		-15°C to +55°C	
	Unmagnified	Magnified	Unmagnified	Magnified
	Within 3%	Within 4%	Within 5%	Within 6%
Over center eight divisions 5 s/DIV to 0.1 s/DIV	Within 3%	Within 4%	Within 4%	Within 5%
50 ms/DIV to 0.1 μs/DIV	Within 3%	Within 4%	Within 4%	Within 5%
Sweep Linearity				
Over any two division portion within center eight divisions (all sweep rates)	Within 5%	Within 5%	Within 5%	Within 10%

TABLE 1-1 (cont)

Characteristic	Performance Requirement	Supplemental Information
Variable Sweep Rate	Continuously variable between calibrated sweep rates.	Extends maximum A sweep rate to at least 12.5 seconds/division and B sweep rate to at least 1.25 seconds/division.
A Sweep Length	Variable from four divisions or less to 10 divisions or greater.	Measured at 1 ms/DIV.

Mixed and Delayed Sweep

Mixed Sweep Accuracy	Within 2% \pm measured A sweep error when viewing the A portion only. B portion accuracy is same as stated under Sweep Accuracy.		Exclude first 0.5 division of displayed sweep and 0.2 division or 0.1 microsecond, whichever is greater, after transition from A to B sweep.
Calibrated Delay Range	Continuous from 50 seconds to 0.2 microseconds.		Selected by DELAY-TIME MULTIPLIER dial and A TIME/DIV switch.
Delay Accuracy Over Center Eight Divisions 5 s to 0.1 s/DIV	0°C to +40°C	-15°C to +55°C	
	Within 1.5% of indicated delay	Within 3.5% of indicated delay	
50 ms to 1 μ s/DIV	Within 1.5% of indicated delay	Within 2% of indicated delay	
Incremental Multiplier Linearity	Within 0.2%	Within 0.3%	
Delay Time Jitter	Less than 1 part in 20,000 of the maximum available delay time (10 times A TIME/DIV switch setting).		

External Horizontal Amplifier

Input to CH 1 or X connector Deflection Factor	5 millivolts/division to 10 volts/division in 11 calibrated steps.		INT TRIG switch set to CH 1 OR X-Y. Steps in 1-2-5 sequence.
Accuracy	0°C to +40°C	-15°C to +55°C	External horizontal gain correctly adjusted at 20 mV.
	Within 5% of indicated deflection	Within 8% of indicated deflection	
X Bandwidth at Upper -3 dB Point	Five megahertz or greater		
Input RC Characteristics Resistance			1 megohm \pm 2%
Capacitance			Approximately 20 picofarads
Phase difference between X and Y amplifiers	3° or less at 50 kilohertz		

TABLE 1-1 (cont)

Characteristic	Performance Requirement	Supplemental Information
Input to EXT TRIG OR X INPUT Connector Deflection Factor	B SOURCE switch in EXT; 270 millivolts/division $\pm 15\%$.	
	B SOURCE switch in EXT $\div 10$; 2.7 volts/division $\pm 20\%$.	
X Bandwidth at Upper -3 dB point	Five megahertz or greater	
Input RC Characteristics		One megohm paralleled by 20 picofarads (approximate)
Phase difference between X and Y amplifiers	3° or less at 50 kilohertz	
Maximum Safe Input Voltage		600 volts DC + peak AC (one kilohertz or less).

CALIBRATOR

Waveshape	Square wave		
Polarity	Positive going.		Baseline at zero volts.
Output Voltage	0.1 volt or 1 volt, peak to peak		Selected by CALIBRATOR switch.
Output Current	Five milliamperes through PROBE LOOP on side panel		
Repetition Rate	One kilohertz.		
Accuracy	0°C to +40°C	-15°C to +55°C	
	Voltage	$\pm 1\%$	$\pm 1.5\%$
	Current	$\pm 1\%$	$\pm 1.5\%$
	Repetition Rate	$\pm 0.5\%$	$\pm 1\%$
Risetime	One microsecond or less		
Output Resistance			Approximately 200 ohms in 1 V position
			Approximately 20 ohms in 0.1 V position

TABLE 1-1 (cont)

Characteristic	Performance Requirement	Supplemental Information
Z AXIS INPUT		
Sensitivity	Five volt peak-to-peak signal produces noticeable modulation at normal intensity.	
Polarity of Operation	Positive-going input signal decreases trace intensity; negative-going input signal increases trace intensity.	
Usable Frequency Range	DC to 50 megahertz or greater.	
Input Resistance at DC		Approximately 47 kilohms
Input Coupling	DC coupled	
Maximum Input Voltage		200 volts DC + peak AC
OUTPUT SIGNALS		
A and B Gate		
Waveshape	Rectangular pulse	
Amplitude	Approximately 12 volts peak	
Polarity	Positive-going	Baseline at about -0.7 volt
Duration	Same duration as respective sweep.	
Output Resistance		Approximately 1.5 kilohms.
Vertical Signal Out (CH 1 only)		
Output Voltage	25 millivolts or greater, for each division of CRT display.	Into one megohm load. INT TRIG switch set to NORM.
Bandwidth	DC to 25 megahertz or greater when cascaded with Channel 2, or into 50-ohm load.	
Output coupling	DC coupled	
Output resistance		Approximately 50 ohms.

TABLE 1-1 (cont)

Characteristic	Performance Requirement	Supplemental Information
DISPLAY		
Graticule Type	Internal	
Area	Eight divisions vertical by 10 divisions horizontal. Each division equals 0.8 centimeter.	
Illumination	Variable edge lighting.	
Phosphor	P31 standard. Others available on special order.	
Beam Finder	Limits display within graticule area when pressed.	
POWER SUPPLY		
Line Voltage	115 volts nominal or 230 volts nominal.	Nominal line voltage and voltage range selected by Line Voltage Selector. Given voltages apply when line voltage contains 2% or less harmonic distortion.
Voltage Ranges (AC, RMS) 115-volts nominal	90 to 110 volts 104 to 126 volts 112 to 136 volts	
230-volts nominal	180 to 220 volts 208 to 252 volts 224 to 272 volts	
Line Frequency		48 to 62 hertz
Maximum Power Consumption		92 watts, one ampere at 60 hertz, 115-volt line

TABLE 1-2
ENVIRONMENTAL CHARACTERISTICS

Characteristic	Performance
<i>NOTE</i>	
<i>This instrument will meet the electrical characteristics given in Table 1-1 over the following environmental limits. Complete details on environmental test procedures, including failure criteria, etc., can be obtained from Tektronix, Inc. Contact your local Tektronix Field Office or representative.</i>	
Temperature Operating	-15°C to +55°C
Storage	-55°C to +75°C
Altitude Operating	15,000 feet maximum. Maximum operating temperature decreases by 1°C per 1000 feet increase in amplitude above 5000 feet.
Storage	Tested to 50,000 feet
Humidity Operating and storage	Five cycles (120 hours) to 95% relative humidity referenced to MIL-E-16400F.
Vibration Operating and non-operating	15 minutes along each of the three major axes at a total displacement of 0.025-inch peak to peak (4 g at 55 Hz) with frequency varied from 10-55-10 Hz in one-minute cycles. Hold at 55 Hz for three minutes on each axis.
Shock Operating and non-operating	Two shocks at 30 g, one-half sine, 11 millisecond duration each direction along each major axis. Guillotine-type shocks. Total of 12 shocks.
Electro-magnetic Interference (EMI) as tested in MIL-I-6181D (when equipped with MOD 163D only)	
Radiated interference	Interference radiated from the instrument under test within the

Characteristic	Performance
	given limits from 150 kilohertz to 1000 megahertz (mesh filter installed).
Conducted interference	Interference conducted out of the instrument under test through the power cord within the given limits from 150 kilohertz to 25 megahertz.
Transportation	Meets National Safe Transit type of test when packaged as shipped from Tektronix, Inc.

TABLE 1-3
PHYSICAL

Characteristic	Information
Cooling	Safe operating temperature maintained by forced-air cooling. Automatic resetting thermal cutout protects instrument from overheating.
Finish	Anodized aluminum panel and chassis. Blue vinyl-coated cabinet.
Overall Dimensions, 453A (measured at maximum points)	
Height	7.2 inches (18.3 centimeters)
Width	12.6 inches (32.0 centimeters)
Length	20.7 inches (52.6 centimeters) including front cover; 22.4 inches (56.9 centimeters) with handle positioned for carrying.
Overall Dimensions, R453A (measured at maximum points)	
Height	7.0 inches (17.8 centimeters)
Width	19 inches (48.3 centimeters)
Length	17.4 inches (44.2 centimeters) behind front panel; 19.2 inches (48.8 centimeters) overall.

Specification—453A/R453A

Characteristic	Information
Net Weight 453A (includes front cover without accessories)	Approximately 30 pounds (13.6 kilograms).
R453A (without accessories)	Approximately 33.5 pounds (15.2 kilograms).

STANDARD ACCESSORIES

Standard accessories supplied with the 453A and R453A are listed in the Mechanical Parts List illustrations. For optional accessories available for use with this instrument, see the current Tektronix, Inc. catalog.

SECTION 2

OPERATING INSTRUCTIONS

Change information, if any, affecting this section will be found at the rear of this manual.

General

To effectively use the 453A, the operation and capabilities of the instrument must be known. This section describes the operation of the front-, side-, and rear-panel controls and connectors, gives first time and general operating information, and lists some basic applications for this instrument.

Front Cover

The front cover furnished with the 453A provides a dust-tight seal around the front panel. Use the cover to protect the front panel when storing or transporting the instrument. The cover also provides storage space for probes and other accessories (see Fig. 2-1).

Operating Voltage

CAUTION

This instrument is designed for operation from a power source with its neutral at or near earth (ground) potential with a separate safety-earth conductor. It is not intended for operation from two phases of a multi-phase system, or across the legs of a single-phase, three-wire system.

The 453A can be operated from either a 115-volt or a 230-volt nominal line-voltage source. The Line Voltage Selector assembly on the rear panel converts the instrument from one operating range to the other. In addition, this assembly changes the primary connections of the power transformer to allow selection of one of three regulating ranges. The assembly also includes the two line fuses. When the instrument is converted from 115-volt to 230-volt nominal operation, or vice versa, the assembly connects or disconnects one of the fuses to provide the correct protection for the instrument. Use the following procedure to convert this instrument between nominal line voltages or regulating ranges.

1. Disconnect the instrument from the power source.
2. Loosen the two captive screws which hold the cover onto the voltage selector assembly; then pull to remove the cover.

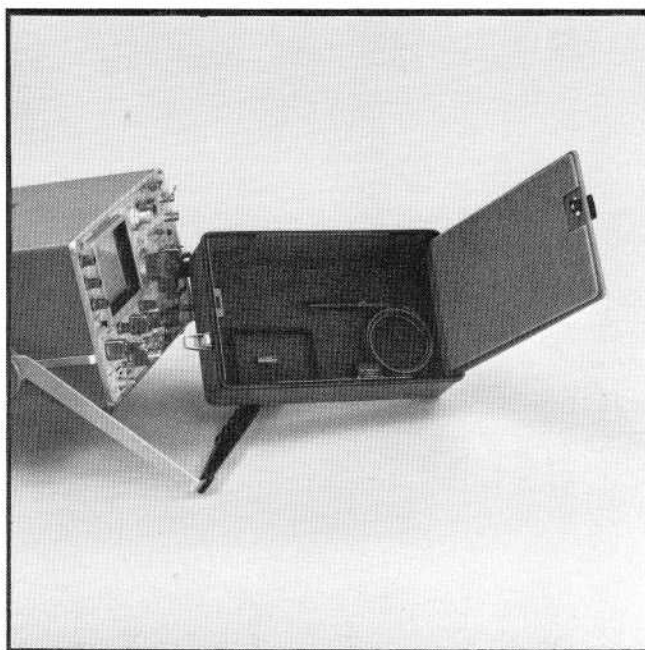


Fig. 2-1. Accessory storage provided in front cover.

3. To convert from 115-volts nominal to 230-volts nominal line voltage, pull out the Voltage Selector switch bar (see Fig. 2-2); turn it around 180° and plug it back into the remaining holes. Change the line-cord power plug to match the power-source receptacle or use a 115- to 230-volt adapter.

NOTE

Color-coding of the cord conductors is as follows (in accordance with National Electrical Code):

<i>Line</i>	<i>Black</i>
<i>Neutral</i>	<i>White</i>
<i>Safety earth (ground)</i>	<i>Green</i>

4. To change regulating ranges, pull out the Range Selector switch bar (see Fig. 2-2); slide it to the desired position and plug it back in. Select a range which is centered about the average line voltage to which the instrument is to be connected (see Table 2-1).

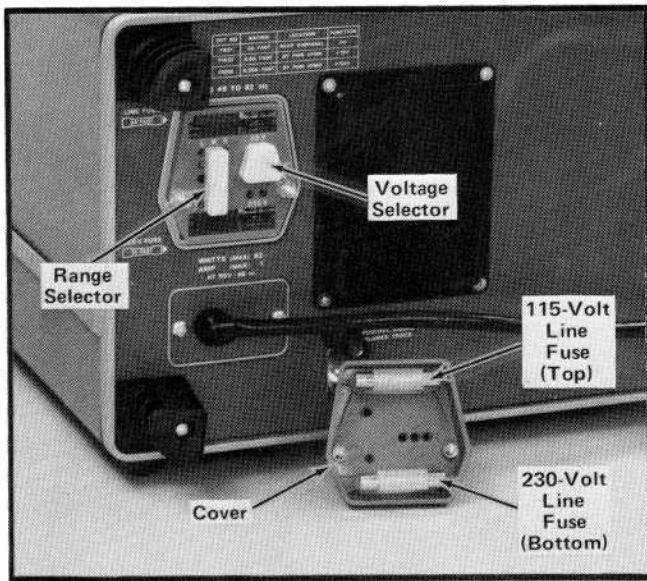


Fig. 2-2. Line Voltage Selector assembly on the rear panel (shown with cover removed).

TABLE 2-1
Regulating Ranges

Range Selector Switch Position	Regulating Range	
	115-Volts Nominal	230-Volts Nominal
LO (switch bar in left holes)	90 to 110 volts	180 to 220 volts
M (switch bar in middle holes)	104 to 126 volts	208 to 252 volts
HI (switch bar in right holes)	112 to 136 volts	224 to 272 volts

5. Re-install the cover and tighten the two captive screws.

6. Before applying power to the instrument, check that the indicating tabs on the switch bars are protruding through the correct holes for the desired nominal line voltage and regulating range.

CAUTION

This instrument may be damaged if operated with the Line Voltage Selector assembly set to incorrect positions for the line voltage applied.

The 453A is designed to be used with a three-wire AC power system. If a three- to two-wire adapter is used to

connect this instrument to a two-wire AC power system, be sure to connect the ground lead of the adapter to earth (ground). Failure to complete the ground system may allow the chassis of this instrument to be elevated above ground potential and pose a shock hazard.

The feet on the rear panel provide a convenient cord wrap to store the power cord when not in use.

Operating Temperature

The 453A is cooled by air drawn in at the rear and blown out through holes in the top and bottom covers. Adequate clearance on the top, bottom, and rear must be provided to allow heat to be dissipated away from the instrument. The clearance provided by the feet at the bottom and rear should be maintained. If possible, allow about one inch of clearance on the top. Do not block or restrict the air flow from the air-escape holes in the cabinet.

A thermal cutout in this instrument provides thermal protection and disconnects the power to the instrument if the internal temperature exceeds a safe operating level. Power is automatically restored when the temperature returns to a safe level. Operation of the instrument for extended periods without the covers may cause it to over-heat and the thermal cutout to open. The air filter should be cleaned occasionally to allow the maximum amount of cooling air to enter the instrument. Cleaning instructions are given in Section 4.

The 453A can be operated where the ambient air temperature is between -15°C and $+55^{\circ}\text{C}$. Derate the maximum operating temperature 1°C for each additional 1000 feet of altitude above 5000 feet. This instrument can be stored in ambient temperatures between -55°C and $+75^{\circ}\text{C}$. After storage at temperatures beyond the operating limits, allow the chassis temperature to come within the operating limits before power is applied.

Operating Position

The handle of the 453A can be positioned for carrying or as a tilt-stand for the instrument. To position the handle, press in at both pivot points (see Fig. 2-3) and turn the handle to the desired position. Several positions are provided for convenient carrying or viewing. The instrument may also be set on the rear-panel feet for operation or storage.

Rackmounting

Complete information for mounting the R453A in a cabinet rack is given in Section 6 of this manual.

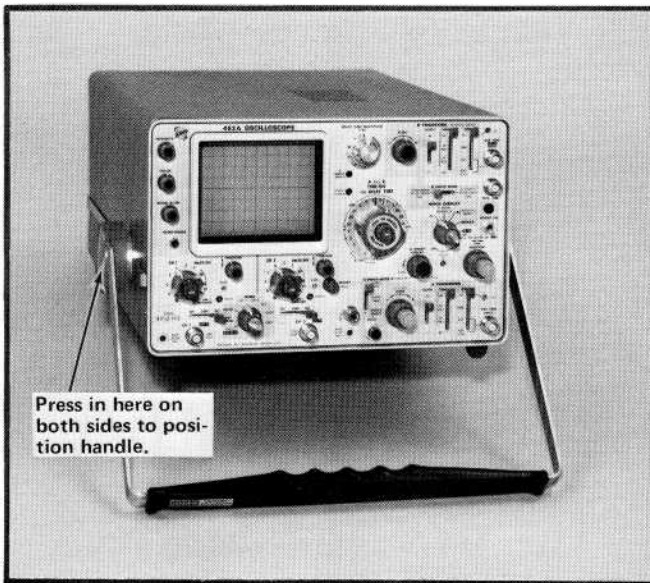


Fig. 2-3. Handle positioned to provide a stand for the instrument.

CONTROLS AND CONNECTORS

General

A brief description of the function or operation of the front-, side-, and rear-panel controls and connectors follows (see Fig. 2-4). More detailed information is given in this section under General Operating Information.

Display

INTENSITY	Controls brightness of display.
FOCUS	Provides adjustment for a well-defined display.
SCALE ILLUM	Controls graticule illumination.
BEAM FINDER	Compresses display within graticule area independent of display position or applied signals.

Vertical (both channels except as noted)

VOLTS/DIV	Selects vertical deflection factor (VAR control must be in calibrated position for indicated deflection factor).
VAR	Provides continuously variable deflection factor between the calibrated settings of the VOLTS/DIV switch.
UNCAL	Light indicates that the VAR control is not in the calibrated position.

POSITION	Controls vertical position of trace.
GAIN	Screwdriver adjustment to set gain of the Vertical Preamp.
Input Coupling (AC GND DC)	Selects method of coupling input signal to Vertical Deflection System. AC: DC component of input signal is blocked. Low frequency limit (−3 dB point) is about 1.6 hertz. GND: Input circuit is grounded (does not ground applied signal). DC: All components of the input signal are passed to the Vertical Deflection System.
STEP ATTEN BAL	Screwdriver adjustment to balance Vertical Deflection System in the 5, 10, and 20 mV positions of the VOLTS/DIV switch.
CH 1 OR X and CH 2 OR Y	Input connector for vertical signal.
MODE	Selects vertical mode of operation. CH 1: The Channel 1 signal is displayed. CH 2: The Channel 2 signal is displayed. ALT: Dual trace display of signal on both channels. Display switched between channels at end of each sweep. CHOP: Dual trace display of signal on both channels. Display switched between channels at a repetition rate of about 500 kilohertz. ADD: Channel 1 and 2 signals are algebraically added and the algebraic sum is displayed on the CRT.
INT TRIG	Selects source of internal trigger signal from vertical system. Also selects source of X signal for X-Y mode operation. NORM: Sweep circuits triggered from displayed channel(s). Channel 1 signal available at CH 1 OUT connector.

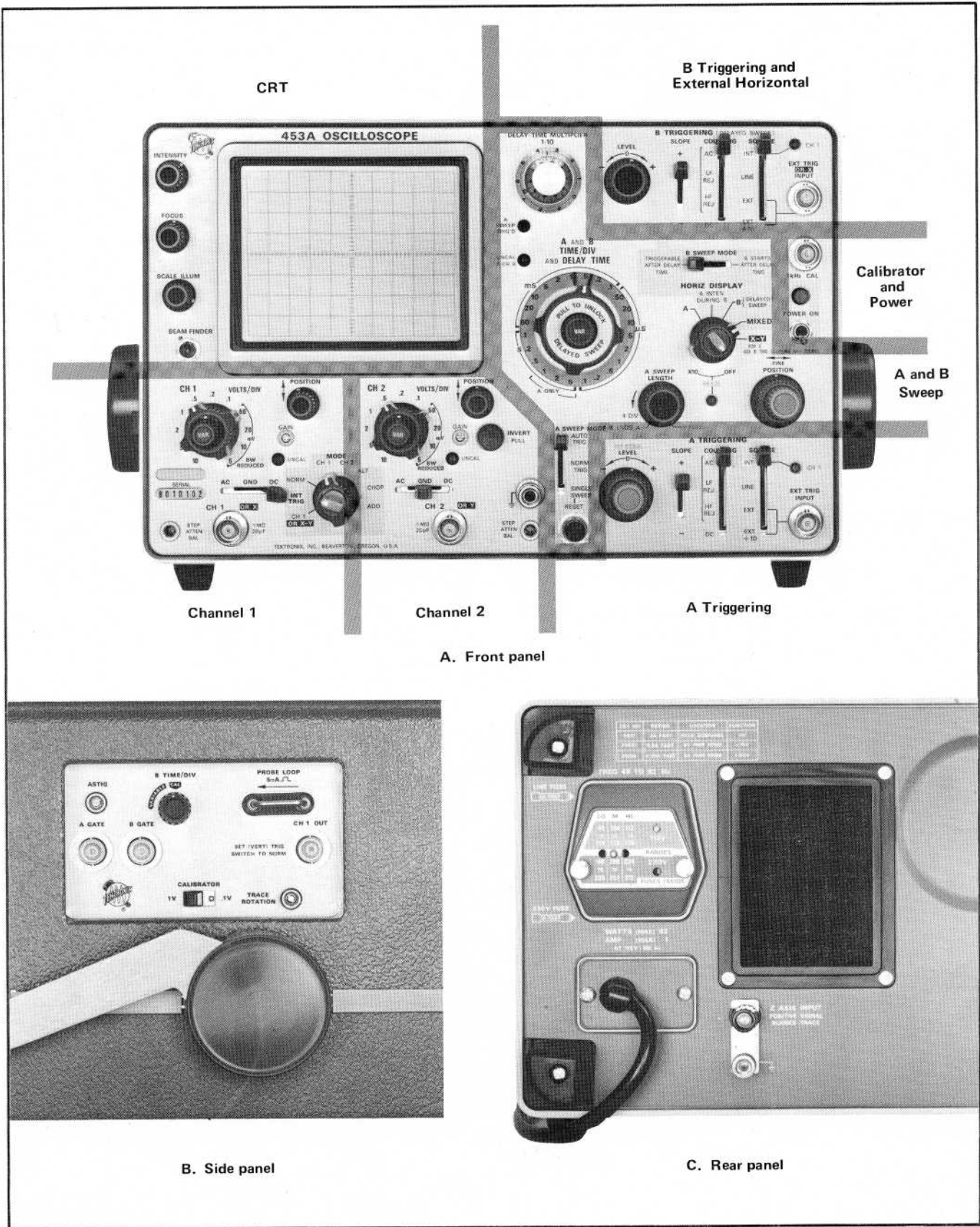


Fig. 2-4. Front-, side-, and rear-panel controls and connectors.

	CH 1 OR X-Y: Sweep circuits triggered only from signal applied to the Channel 1 input connector. No signal available at CH 1 OUT connector. CH 1 lights, located beside A and B SOURCE switches indicate when the INT TRIG switch is in the CH 1 OR X-Y position. For X-Y mode operation, Channel 1 signal is connected to the Horizontal Amplifier.		the signal connected to the CH 1 OR X connector (see INT TRIG switch).
		COUPLING	Determines method of coupling trigger signal to trigger circuit. AC: Rejects DC and attenuates signals below about 30 hertz. Accepts signals between about 30 hertz and 60 megahertz. LF REJ: Rejects DC and attenuates signals below about 30 kilohertz. Accepts signals between about 30 kilohertz and 60 megahertz. HF REJ: Accepts signals between about 30 hertz and 50 kilohertz; rejects DC and attenuates signals outside the above range. DC: Accepts all trigger signals from DC to 60 megahertz or greater.
INVERT (CH 2 only)	Inverts the Channel 2 signal when pulled out.		
Ground (not labeled)	Binding post to establish common ground between the 453A and any associated equipment.		
A and B Triggering (both where applicable)			
EXT TRIG INPUT	Input connector for external trigger signal. Connector for B Triggering also serves as external horizontal input for the X signal when HORIZ DISPLAY switch is in X-Y position and B SOURCE switch is in EXT position.	SLOPE	Selects portion of trigger signal which starts the sweep. +: Sweep can be triggered from positive-going portion of trigger signal. -: Sweep can be triggered from negative-going portion of trigger signal.
SOURCE	Selects source of trigger signal. INT: Internal trigger signal obtained from Vertical Deflection System. When CH 1 light is on, trigger signal is obtained only from the Channel 1 input signal; when the light is off, the trigger signal is obtained from the displayed channel(s). Source of internal trigger signal is selected by the INT TRIG switch. LINE: Trigger signal obtained from a sample of the line voltage applied to this instrument. EXT: Trigger signal obtained from an external signal applied to the EXT TRIG INPUT connector. EXT ÷ 10: Attenuates external trigger signal approximately 10 times.	LEVEL HF STAB (A Triggering only)	Selects amplitude point on trigger signal at which sweep is triggered. Decreases display jitter for high-frequency signals. Has negligible effect at low sweep rates.
A and B Sweep			
		DELAY-TIME MULTIPLIER	Provides variable sweep delay between 0.20 and 10.20 times the delay time indicated by the A TIME/DIV switch.
		A SWEEP TRIG'D	Light indicates that A sweep is triggered and will produce a stable display with correct INTENSITY and POSITION control settings.
CH 1	Light indicates that the internal trigger signal is obtained only from	UNCAL A OR B	Light indicates that either the A VAR or B TIME/DIV VARIABLE control is not in the calibrated position.

Operating Instructions—453A/R453A

A AND B TIME/DIV AND DELAY TIME	A TIME/DIV switch (clear plastic flange) selects the sweep rate of the A sweep circuit for A sweep only operation and selects the basic delay time (to be multiplied by DELAY-TIME MULTIPLIER dial setting) for mixed or delayed sweep operation. B TIME/DIV (DELAYED SWEEP) switch selects sweep rate of the B sweep circuit for mixed or delayed sweep operation only. Variable controls must be in calibrated positions for calibrated sweep rates.	determined by the setting of the DELAY TIME (A TIME/DIV) switch and the DELAY-TIME MULTIPLIER dial. Sweep mode determined by B SWEEP MODE switch.
A VAR	Provides continuously variable A sweep rate between calibrated settings of the A TIME/DIV switch. A sweep rate is calibrated when control is set fully clockwise to calibrated position.	MIXED: Both time bases are operating. The sweep rate of the first part of the sweep is determined by the A TIME/DIV switch; the last part is determined by the B TIME/DIV switch. The amount of display allocated to each time base is determined by the setting of the DELAY-TIME MULTIPLIER dial.
B SWEEP MODE	Selects B sweep operation mode.	X-Y: Horizontal deflection provided by an external signal.
	TRIGGERABLE AFTER DELAY TIME: B sweep circuit will not produce a sweep until a trigger pulse is received following the delay time selected by the DELAY TIME (A TIME/DIV) switch and the DELAY-TIME MULTIPLIER dial.	MAG Increases sweep rate to ten times setting of A or B TIME/DIV switch by horizontally expanding the center division of the display. Light indicates when magnifier is on.
	B STARTS AFTER DELAY TIME: B sweep circuit runs immediately following delay time selected by the DELAY TIME switch and DELAY-TIME MULTIPLIER dial.	A SWEEP MODE Determines the operating mode for A sweep.
HORIZ DISPLAY	Selects horizontal mode of operation.	AUTO TRIG: Sweep initiated by the applied trigger signal at point selected by the A LEVEL control when the trigger signal repetition rate is above about 20 hertz and within the frequency range selected by the A COUPLING switch. Triggered sweep can be obtained only over the amplitude range of the applied signal. When the A LEVEL control is outside the amplitude range, the trigger repetition rate is below the lower frequency limit (or above upper limit for HF REJ), or the trigger signal is inadequate, the sweep free runs at the sweep rate selected by the A TIME/DIV switch to produce a bright reference trace.
	A: Horizontal deflection provided by A sweep. B sweep inoperative.	NORM TRIG: Sweep initiated by the applied trigger signal at point selected by A LEVEL control over the frequency range selected by the A COUPLING switch. Triggered sweep can be obtained only over the amplitude range of the applied trigger signal. When the A LEVEL control is outside
	A INTEN DURING B: Sweep rate determined by A TIME/DIV switch. An intensified portion appears on the display during the B sweep time. This position provides a check of the duration and position of the delayed sweep (B) with respect to the delaying sweep (A).	
	B (DELAYED SWEEP): Sweep rate determined by B TIME/DIV switch after the delay time	

the amplitude range, the trigger repetition rate is outside the frequency range selected by the A COUPLING switch, or the trigger signal is inadequate, there is no trace.

SINGLE SWEEP: After a sweep is displayed, further sweeps cannot be presented until the RESET button is pressed. Display is triggered as for NORM operation using the A Triggering controls.

RESET When the RESET button is pressed (SINGLE SWEEP mode), a single display will be presented (with correct triggering) when the next trigger pulse is received. RESET light (inside RESET button) remains on until a trigger is received and the sweep is completed. RESET button must be pressed before another sweep can be presented.

A SWEEP LENGTH Adjusts length of A sweep. In the FULL position (clockwise detent), the sweep is at least 10 divisions long. As the control is rotated counterclockwise, the length of A sweep is reduced until it is less than four divisions long just before the detent in the fully-counterclockwise position is reached. In the B ENDS A position (counterclockwise detent), the A sweep is reset at the end of the B sweep to provide the fastest possible sweep repetition rate for delayed sweep displays.

POSITION Controls horizontal position of trace.

FINE Provides more precise horizontal position adjustment.

1 kHz Calibrator output connector.

POWER ON Light: Indicates that POWER switch is on and the instrument is connected to a line voltage source.

Switch: Controls power to the instrument.

Side Panel

ASTIG Screwdriver adjustment used in conjunction with the FOCUS control

to obtain a well-defined display. Does not require re-adjustment in normal use.

B TIME/DIV-VARIABLE Provides continuously variable B sweep rate between calibrated settings of B TIME/DIV switch. B sweep rate is calibrated when control is set fully clockwise to CAL.

PROBE LOOP Current loop providing five-milliamper square-wave current from calibrator circuit.

A GATE Output connector providing a rectangular pulse coincident with A sweep.

B GATE Output connector providing a rectangular pulse coincident with B sweep.

CH 1 OUT Output connector providing a sample of the signal applied to the CH 1 OR X connector when the INT TRIG switch is in the NORM position.

CALIBRATOR Switch selects output voltage of Calibrator. 1-volt or 0.1-volt square wave available.

TRACE ROTATION Screwdriver adjustment to align trace with horizontal graticule lines.

Rear Panel

Z AXIS INPUT Input connector for intensity modulation of the CRT display.

Line Voltage Selector Switching assembly to select the nominal operating voltage and the line voltage range. The assembly also includes the line fuses.

Voltage Selector: Selects nominal operating voltage range (115 V or 230 V).

Range Selector: Selects line voltage range (low, medium, high).

FIRST-TIME OPERATION

General

The following steps will demonstrate the use of the controls and connectors of the 453A. It is recommended that this procedure be followed completely for familiarization with this instrument.

Setup Information

1. Set the controls as follows:

Display Controls

INTENSITY	Counterclockwise
FOCUS	Midrange
SCALE ILLUM	Counterclockwise

Vertical Controls (both channels if applicable)

VOLTS/DIV	20 mV
VAR	Calibrated
POSITION	Midrange
Input Coupling	DC
MODE	CH 1
INT TRIG	NORM
INVERT	Pushed in

Triggering Controls (both A and B if applicable)

LEVEL	Clockwise (+)
SLOPE	+
COUPLING	AC
SOURCE	INT

Sweep Controls

DELAY-TIME	0.20
MULTIPLIER	
A and B TIME/DIV	.5 ms
A VAR	Calibrated
B SWEEP MODE	B STARTS AFTER DELAY TIME
HORIZ DISPLAY	A
MAG	OFF
POSITION	Midrange
A SWEEP LENGTH	FULL
A SWEEP MODE	AUTO TRIG
POWER	OFF

Side Panel Controls

B TIME/DIV	CAL
VARIABLE	
CALIBRATOR	.1 V

2. Connect the 453A to a power source that meets the voltage and frequency requirements of the instrument. If the available line voltage is outside the limits of the Line Voltage Selector assembly (on rear panel), see Operating Voltage in this section.

3. Set the POWER switch to ON. Allow about five minutes warmup so the instrument reaches a normal operating temperature before proceeding.

Display

4. Advance the INTENSITY control until the trace is at the desired viewing level (near midrange).

5. Connect the 1 kHz CAL connector to the CH 1 OR X connector with a BNC cable.

6. Turn the A LEVEL control toward 0 until the display becomes stable. Note that the A SWEEP TRIG'D light is on when the display is stable.

7. Adjust the FOCUS control for a sharp, well-defined display over the entire trace length. (If focused display cannot be obtained, see Astigmatism Adjustment in this section.)

8. Disconnect the input signal and move the trace with the Channel 1 POSITION control so it coincides with one of the horizontal graticule lines. If the trace is not parallel with the graticule line, see Trace Alignment Adjustment in this section.

9. Rotate the SCALE ILLUM control throughout its range and notice that the graticule lines are illuminated as the control is turned clockwise (most obvious with mesh or tinted filter installed). Set control so graticule lines are illuminated as desired.

Vertical

10. Change the CH 1 VOLTS/DIV switch from 20 mV to 5 mV. If the vertical position of the trace shifts, see Step Attenuator Balance in this section.

11. Set the CH 1 VOLTS/DIV switch to 20 mV and set the Channel 1 Input Coupling switch to AC. Connect the 1 kHz CAL connector to both the CH 1 OR X and CH 2 OR Y connectors with two BNC cables and a BNC T connector.

NOTE

If the BNC cables and BNC T connector are not available, make the following changes in the procedure. Place the BNC jack post (supplied accessory) on the 1 kHz CAL connector and connect the two 10X probes (supplied accessories) to the CH 1 and CH 2 connectors. Connect the probe tips to the BNC jack post. Set the CALIBRATOR switch (on side-panel) to 1 V.

12. Turn the Channel 1 POSITION control to center the display. The display is a square wave, five divisions in ampli-

tude with about five cycles displayed on the screen. If the display is not five divisions in amplitude, see Vertical Gain Adjustment in this section.

13. Set the Channel 1 Input Coupling switch to GND and position the trace to the center horizontal line with the Channel 1 POSITION control. This provides a ground reference at the center horizontal line.

14. Set the Channel 1 Input Coupling switch to DC. Note that the baseline of the waveform remains at the center horizontal line (ground reference).

15. Set the Channel 1 Input Coupling switch to AC. Note that the waveform is centered about the center horizontal line (ground reference).

16. Turn the Channel 1 VAR control throughout its range. Note that the UNCAL light comes on when the VAR control is moved from the calibrated position (fully clockwise). The deflection should be reduced to about two divisions. Return the VAR control to the calibrated position.

17. Set the MODE switch to CH 2.

18. Turn the Channel 2 POSITION control to center the display. The display will be similar to the previous display for Channel 1. Check Channel 2 step attenuator balance and gain as described in steps 10 through 12. The Channel 2 Input Coupling switch and VAR control operate as described in steps 13 through 16.

19. Set both VOLTS/DIV switches to 50 mV.

20. Set the MODE switch to ALT and position the Channel 1 waveform to the top of the graticule area and the Channel 2 waveform to the bottom of the graticule area. Turn the A TIME/DIV switch throughout its range. Note that the display alternates between channels at all sweep rates.

21. Set the MODE switch to CHOP and the A TIME/DIV switch to 10 μ s. Note the switching between channels as shown by the segmented trace. Set the INT TRIG switch to CH 1 OR X-Y; the trace should appear more solid, since it is no longer triggered on the between-channel switching transients. Turn the A TIME/DIV switch throughout its range. A dual-trace display is presented at all sweep rates, but unlike ALT, both channels are displayed on each trace on a time-sharing basis. Return the A TIME/DIV switch to .5 ms.

22. Set the MODE switch to ADD. The display should be four divisions in amplitude. Note that either POSITION control moves the display.

23. Pull the INVERT switch. The display is a straight line indicating that the algebraic sum of the two signals is zero (if the Channel 1 and 2 gain is correct).

24. Set either VOLTS/DIV switch to 20 mV. The square-wave display indicates that the algebraic sum of the two signals is no longer zero. Return the MODE switch to CH 1 and both VOLTS/DIV switches to .2 (if using 10X probes, set both VOLTS/DIV switches to 20 mV). Push in the INVERT switch.

Triggering

25. Set the CALIBRATOR switch to 1 V. Rotate the A LEVEL control throughout its range. The display free runs at the extremes of rotation. Note that the A SWEEP TRIG'D light is on only when the display is triggered.

26. Set the A SWEEP MODE switch to NORM TRIG. Again rotate the A LEVEL control throughout its range. A display is presented only when correctly triggered. The A SWEEP TRIG'D light operates as in AUTO TRIG. Return the A SWEEP MODE switch to AUTO TRIG and set the A LEVEL control for a stable display.

27. Set the A SLOPE switch to -. The trace starts on the negative part of the square wave. Return the switch to +; the trace starts with the positive part of the square wave.

28. Set the A COUPLING switch to DC. Turn the Channel 1 POSITION control until the display becomes unstable (only part of square wave visible). Return the A COUPLING switch to AC; the display is again stable. Since changing trace position changes DC level, this shows how DC level changes affect DC trigger coupling. Return the display to the center of the screen.

29. Set the MODE switch to CH 2; the display should be stable. Remove the signal connected to Channel 1; the display free runs. Set the INT TRIG switch to NORM; the display is again stable. Note that the CH 1 lights in A and B Triggering go out when the INT TRIG switch is changed to NORM.

30. Set the A SOURCE switch to LINE. Connect a 10X probe (supplied accessory) to the CH 2 OR Y connector. Connect the probe tip to a line-voltage source and set the CH 2 VOLTS/DIV switch for a display about four divisions in amplitude. If necessary, adjust the A LEVEL control for

Operating Instructions—453A/R453A

a stable display of the sine-wave. Notice that the display starts on the correct slope. Disconnect the probe.

31. Connect the Calibrator signal to both the CH 2 OR Y and A EXT TRIG INPUT connectors. Set the A SOURCE switch to EXT. Operation of the LEVEL, SLOPE, and COUPLING controls for external triggering are the same as described in steps 25 through 28.

32. Set the A SOURCE switch to EXT ÷ 10. Operation is the same as for EXT. Note that the A LEVEL control has less range in this position, indicating trigger signal attenuation. Return the A SOURCE switch to INT.

33. Operation of the B Triggering controls is similar to A Triggering.

Normal and Magnified Sweep

34. Set the A TIME/DIV switch to 5 ms and the MAG switch to X10. The display should be similar to that obtained with the A TIME/DIV switch set to .5 ms and the MAG switch to OFF.

35. Turn the horizontal POSITION control throughout its range; it should be possible to position the display across the complete graticule area. Now turn the FINE control. The display moves a smaller amount and allows more precise positioning. Return the A TIME/DIV switch to .5 ms, the MAG switch to OFF and return the start of the trace to the left graticule line.

36. Turn the A VAR control throughout its range. Notice that the UNCAL A OR B light comes on when the A VAR control is moved from the calibrated position (fully clockwise). The sweep rate is slower by about 2.5 times in the fully counterclockwise position as indicated by more cycles displayed on the CRT. Return the A VAR control to the calibrated position.

Delayed Sweep

37. Pull the DELAYED SWEEP knob out and turn it to 50 μ s (DELAY TIME remains at .5 ms). Set the HORIZ DISPLAY switch to A INTEN DURING B. An intensified portion, about one division in length, should be shown at the start of the trace. Rotate the DELAY-TIME MULTIPLIER dial throughout its range; the intensified portion should move along the display.

38. Set the B SWEEP MODE switch to TRIGGERABLE AFTER DELAY TIME. Again rotate the DELAY-TIME MULTIPLIER dial throughout its range and note that the

intensified portion appears to jump between positive slopes of the display. Set the B SLOPE switch to —; the intensified portion begins on the negative slope. Rotate the B LEVEL control; the intensified portion of the display disappears when the B LEVEL control is out of the triggerable range. Return the B LEVEL control to 0.

39. Set the HORIZ DISPLAY switch to B (DELAYED SWEEP). Rotate the DELAY-TIME MULTIPLIER dial throughout its range; about one-half cycle of the waveform should be displayed on the screen (leading edge visible only at high INTENSITY control setting). The display remains stable on the screen, indicating that the B sweep is triggered.

40. Set the B SWEEP MODE switch to B STARTS AFTER DELAY TIME. Rotate the DELAY-TIME MULTIPLIER dial throughout its range; the display moves continuously across the screen as the control is rotated.

41. Rotate the DELAY-TIME MULTIPLIER dial fully counterclockwise and set the HORIZ DISPLAY switch to A INTEN DURING B. Rotate the A SWEEP LENGTH control counterclockwise; the length of the display decreases. Set the control to the B ENDS A position; now the display ends after the intensified portion. Rotate the DELAY-TIME MULTIPLIER dial and note that the sweep length increases as the display moves across the screen. Return the A SWEEP LENGTH control to FULL.

42. Turn the B VARIABLE control (on side panel) throughout its range. Notice that the UNCAL A OR B light comes on when the B VARIABLE control is moved from the CAL position (fully clockwise). The B sweep rate (intensified portion) is slower by about 2.5 times in the fully counterclockwise position, as indicated by a longer intensified zone. Return the B VARIABLE control to CAL.

43. Set the HORIZ DISPLAY switch to MIXED and the DELAY-TIME MULTIPLIER to 5.00. Notice that the first half of the sweep is at the sweep rate of the A time base (5 ms/DIV), and the last half is at the sweep rate of the B time base (0.5 ms/DIV). Rotate the DELAY-TIME MULTIPLIER dial throughout its range and notice that the display switches between time bases at the point indicated by the DELAY-TIME MULTIPLIER dial. Return the HORIZ DISPLAY switch to A.

Single Sweep

44. Set the A SWEEP MODE switch to SINGLE SWEEP. Remove the Calibrator signal from the CH 2 OR Y connector. Press the RESET button; the RESET light should come on and remain on. Again apply the signal to the CH 2 OR Y connector; a single trace should be presented and the

RESET light should go out. Return the A SWEEP MODE switch to AUTO TRIG.

External Horizontal

45. Connect the Calibrator signal to both the CH 2 OR Y and EXT TRIG OR X INPUT connectors. Set the B SOURCE switch to EXT, B COUPLING switch to DC, and the HORIZ DISPLAY switch to X-Y. Increase the INTENSITY control setting until the display is visible (two dots displayed diagonally). The display should be five divisions vertically and about 3.7 divisions horizontally. Set the B SOURCE switch to EXT \div 10. The display should be reduced 10 times horizontally. The display can be positioned horizontally with the horizontal POSITION or FINE control, and vertically with the Channel 2 POSITION control.

46. Connect the Calibrator signal to both the CH 1 OR X and CH 2 OR Y connectors. Set the INT TRIG switch to CH 1 OR X-Y and the B SOURCE switch to INT.

47. The display should be five divisions vertically and horizontally. The display can be positioned horizontally with the Channel 1 POSITION control and vertically with the Channel 2 POSITION control.

48. Change the CH 1 VOLTS/DIV switch to .5. The display is reduced to two divisions horizontally. Now set the CH 2 VOLTS/DIV switch to .5. The display is reduced to two divisions vertically.

Beam Finder

49. Set the CH 1 and CH 2 VOLTS/DIV switches to 10 mV. The display is not visible since it exceeds the scan area of the CRT.

50. Press the BEAM FINDER switch. Note that the display is returned to the graticule area. While holding the BEAM FINDER switch depressed, increase the vertical and horizontal deflection factors until the display is reduced to about two divisions vertically and horizontally. Adjust the Channel 1 and 2 POSITION controls to center the display about the center lines of the graticule. Release the BEAM FINDER and note that the display remains within the viewing area. Disconnect the applied signal.

51. Reduce the INTENSITY control setting to normal, B SOURCE switch to INT, and set the HORIZ DISPLAY switch to A.

Z-Axis Input

52. If an external signal is available (five volts peak to peak minimum) the function of the Z AXIS INPUT circuit

can be demonstrated. Remove the ground strap between the Z AXIS INPUT binding posts. Connect the external signal to both the CH 2 OR Y connector and the Z AXIS INPUT binding posts. Set the A TIME/DIV switch to display about five cycles of the waveform. The positive peaks of the waveform should be blanked and the negative peaks intensified, indicating intensity modulation. Replace the ground strap.

53. This completes the basic operating procedure for the 453A. Instrument operations not explained here, or operations which need further explanation are discussed under General Operating Information.

TEST SET-UP CHART

Fig. 2-5 shows the front, side, and rear panels of the 453A. This chart can be reproduced and used as a test-setup record for special measurements, applications or procedures, or it may be used as a training aid for familiarization with this instrument.

GENERAL OPERATING INFORMATION

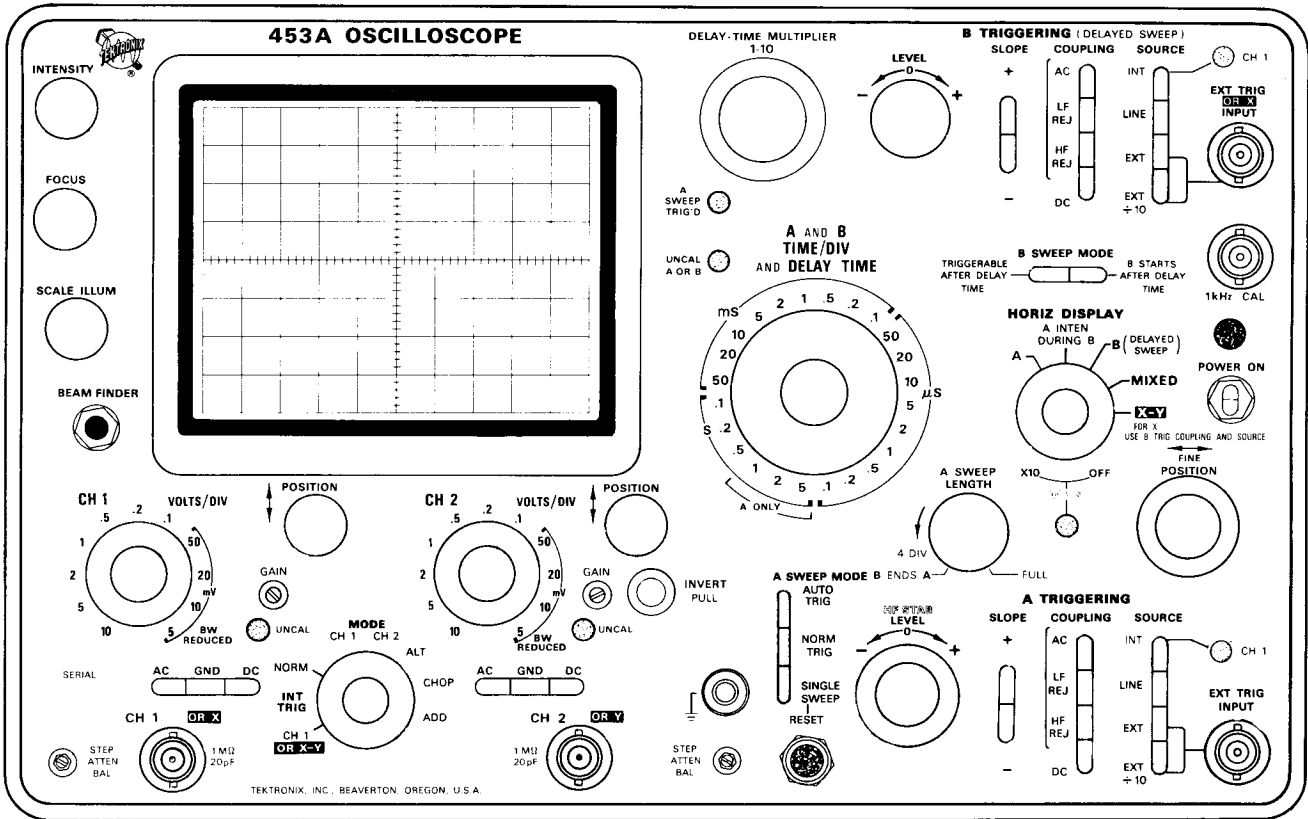
Simplified Operating Instructions

General. The following information is provided to aid in quickly obtaining the correct setting for the 453A to present a display. The operator should be familiar with the complete function and operation of the instrument as described in this section before using this procedure.

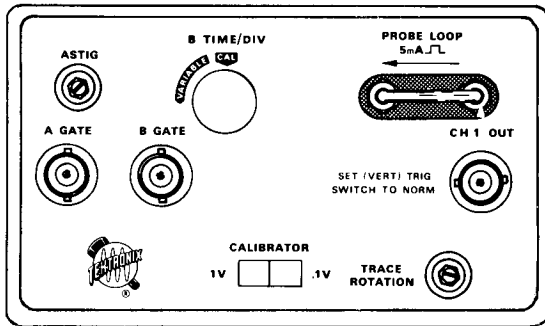
Normal Sweep Display (Y-T Display)

1. Set the INTENSITY control fully counterclockwise.
2. Set the Input Coupling switch to AC, VAR VOLTS/DIV control to calibrated, and vertical MODE switch to CH 1 (use ALT or CHOP for dual-trace display).
3. Set the A SWEEP MODE, A SLOPE, A COUPLING, and A SOURCE switches to their up positions.
4. Set the A TIME/DIV switch to 1 ms/DIV, A VAR TIME/DIV control to calibrated, and HORIZ DISPLAY switch to A.
5. Set the POWER switch to ON. Allow several minutes warmup.
6. Connect the signal to the CH 1 OR X connector.

453A TEST SET—UP CHART



A. Front panel



B. Side panel

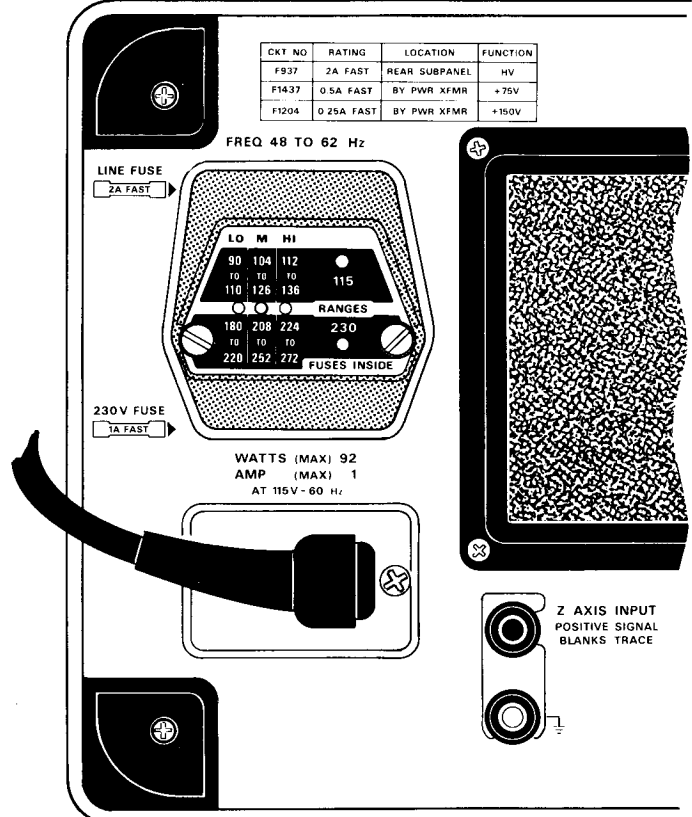


Fig. 2-5.

C. Rear panel

7. Advance the INTENSITY control until a display is visible (if display is not visible with the INTENSITY control at midrange, press the BEAM FINDER switch and adjust the VOLTS/DIV switch until the display is reduced in size vertically; then center the compressed display with the vertical and horizontal POSITION controls; release the BEAM FINDER). Set the FOCUS control for a well-defined display.

8. Set the VOLTS/DIV switch and vertical POSITION control for a display which remains within the graticule area vertically.

9. Set the A LEVEL control for a stable display.

10. Set the A TIME/DIV switch and horizontal POSITION control for a display which remains within the graticule area horizontally.

Magnified Sweep Display (Y-T Display)

1. Follow steps 1 – 10 for Normal Sweep Display.

2. Adjust the horizontal POSITION control to move the area to be magnified within the center division of the CRT. If necessary, change the TIME/DIV switch setting so the complete area to be magnified is within the center division.

3. Set the MAG switch to X10 and adjust the horizontal FINE control for precise positioning of the magnified display.

Delayed Sweep Display (Y-T Display)

1. Follow steps 1 – 10 for Normal Sweep Display.

2. Set the B SWEEP MODE switch to B STARTS AFTER DELAY TIME, HORIZ DISPLAY switch to A INTEN DURING B, and the A SWEEP LENGTH control to FULL.

3. Pull out the DELAYED SWEEP (B TIME/DIV) switch and turn clockwise so the intensified zone on the display is the desired length (intensified zone will be displayed in delayed form). If an intensified zone is not visible, change the INTENSITY control setting.

4. Adjust the DELAY-TIME MULTIPLIER dial to position the intensified zone to the portion of the display to be delayed.

5. Set the HORIZ DISPLAY switch to B (DELAYED SWEEP). Delayed sweep rate is shown by the dot on the DELAYED SWEEP (B TIME/DIV) knob.

6. For a delayed sweep display with less jitter, set the B SWEEP MODE switch to TRIGGERABLE AFTER DELAY TIME, all B Triggering switches up, and adjust the B LEVEL control for a stable display.

Mixed Sweep Display (Y-T Display)

1. Follow steps 1 – 10 for Normal Sweep Display.

2. Set the B SWEEP MODE switch to B STARTS AFTER DELAY TIME, HORIZ DISPLAY switch to MIXED, and A SWEEP LENGTH to FULL.

3. Pull out the DELAYED SWEEP (B TIME/DIV) switch and turn clockwise to obtain the amount of magnification desired.

4. Adjust the DELAY-TIME MULTIPLIER dial to vary the amount of delay time before the start of the magnified portion of the display.

5. For mixed sweep display with less jitter, set the B SWEEP MODE switch to TRIGGERABLE AFTER DELAY TIME, all B Triggering switches up, and adjust the B LEVEL control for a stable display.

X-Y Display

1. Set the INTENSITY control fully counterclockwise.

2. Set both Input Coupling switches to AC and VAR VOLTS/DIV controls to calibrated.

3. Set the INT TRIG switch to CH 1 OR X-Y, HORIZ DISPLAY switch to X-Y, B SOURCE switch to INT, the Vertical MODE switch to CH 2, and the B COUPLING switch to DC. Center the horizontal POSITION control.

4. Set the POWER switch to ON. Allow several minutes warmup.

5. Connect the X (horizontal) signal to the CH 1 OR X connector and the Y (vertical) signal to the CH 2 OR Y connector.

6. Advance the INTENSITY control until a display is visible (if no display is visible, press the BEAM FINDER switch and adjust the CH 1 and CH 2 VOLTS/DIV switches until the display is reduced in size both vertically and horizontally; then center the compressed display with the CH 1 and CH 2 POSITION controls; release the BEAM FINDER). Set the FOCUS control for a well-defined display.

7. Set the CH 1 and CH 2 VOLTS/DIV switches and POSITION controls for a display which remains within the graticule area (leave the horizontal POSITION control set to midrange). CH 1 controls affect horizontal deflection and CH 2 controls affect vertical deflection.

Intensity Control

The setting of the INTENSITY control may affect the correct focus of the display. Slight re-adjustment of the FOCUS control may be necessary when the intensity level is changed. To protect the CRT phosphor, do not turn the INTENSITY control higher than necessary to provide a satisfactory display. The light filters reduce the observed light output from the CRT. When using these filters, avoid advancing the INTENSITY control to a setting that may burn the phosphor. When the highest intensity display is desired, remove the filters and use only the clear faceplate protector. Apparent trace intensity can also be improved in such cases by reducing the ambient light or using a viewing hood. Also, be careful that the INTENSITY control is not set too high when changing the TIME/DIV switch from a fast to a slow sweep rate, or when changing to the external horizontal mode of operation.

Astigmatism Adjustment

If a well-defined display cannot be obtained with the FOCUS control, adjust the ASTIG adjustment (side panel) as follows.

NOTE

To check for proper setting of the ASTIG adjustment, slowly turn the FOCUS control through the optimum setting. If the ASTIG adjustment is correctly set, the vertical and horizontal portions of the display will come into sharpest focus at the same position of the FOCUS control. This setting of the ASTIG adjustment should be correct for any display. However, it may be necessary to reset the FOCUS control slightly when the INTENSITY control is changed.

1. Connect a 1 V Calibrator signal to either channel and set the VOLTS/DIV switch of that channel to present a two-division display. Set the MODE switch to display the channel selected.

2. Set the TIME/DIV switch to .2 ms.

3. With the FOCUS control and ASTIG adjustment set to midrange, adjust the INTENSITY control so the rising portion of the display can be seen.

4. Set the ASTIG adjustment so the horizontal and vertical portions of the display are equally focused, but not necessarily well focused.

5. Set the FOCUS control so the vertical portion of the trace is as thin as possible.

6. Repeat steps 4 and 5 for best overall focus. Make final check at normal intensity.

Graticule

The graticule of the 453A is internally marked on the faceplate of the CRT to provide accurate, no-parallax measurements. The graticule is marked with eight vertical and 10 horizontal divisions. Each division is 0.8 centimeter square. In addition, each major division is divided into five minor divisions at the center vertical and horizontal lines. The vertical gain and horizontal timing are calibrated to the graticule so accurate measurements can be made from the CRT. The illumination of the graticule lines can be varied with the SCALE ILLUM control.

Fig. 2-6 shows the graticule of the 453A and defines the various measurement lines. The terminology defined here

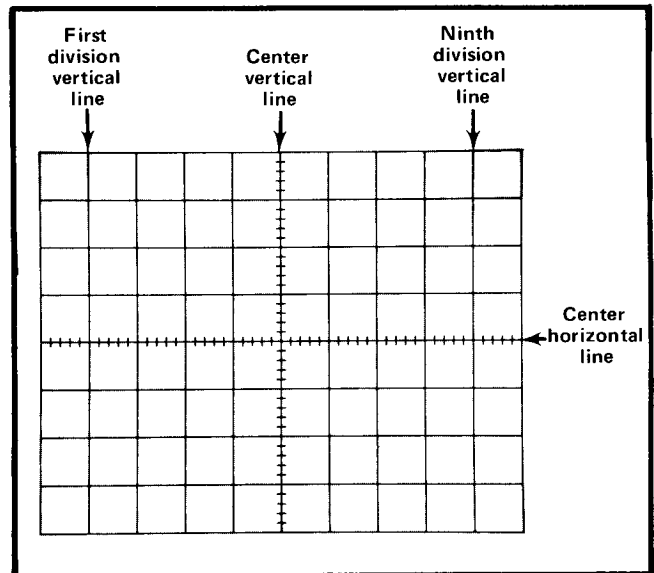


Fig. 2-6. Definition of measurement lines on 453A graticule.

will be used in all discussions involving graticule measurements.

Trace Alignment Adjustment

If a free-running trace is not parallel to the horizontal graticule lines, set the TRACE ROTATION adjustment as follows. Position the trace to the center horizontal line. Adjust the TRACE ROTATION adjustment (side panel) so the trace is parallel with the horizontal graticule lines.

Light Filter

The tinted filter provided with the 453A minimizes light reflections from the face of the CRT to improve contrast when viewing the display under high ambient light conditions. A clear plastic faceplate protector is also provided with this instrument for use when neither the mesh nor the tinted filter is used. The clear faceplate protector provides the best display for waveform photographs. It is also preferable for viewing high writing rate displays. To remove the filter from the CRT, press down at the bottom of the frame and pull the top of the filter away from the CRT faceplate (see Fig. 2-7).

An optional mesh filter is available for use with the 453A (standard with MOD 163D). This filter provides shielding against radiated EMI (electro-magnetic interference) from the face of the CRT. It also serves as a light filter to make the trace more visible under high ambient light conditions. The mesh filter fits in place of the tinted

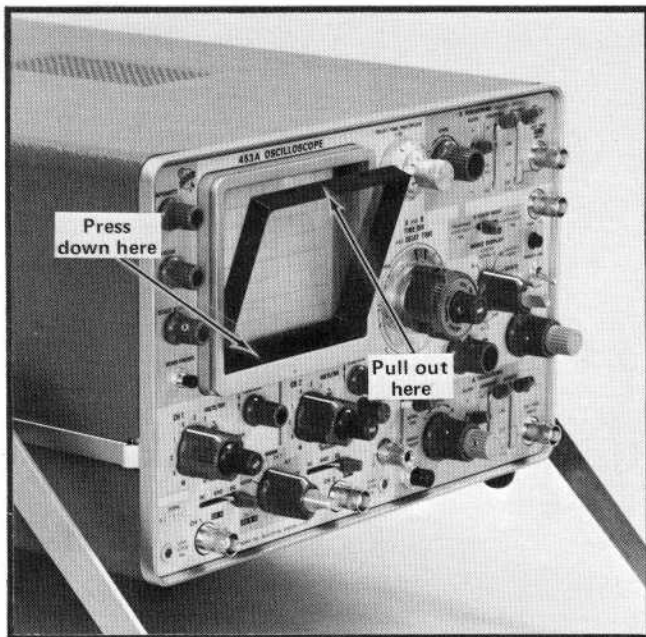


Fig. 2-7. Removing the filter or faceplate protector.

filter or clear faceplate protector. It can be ordered by Tektronix Part No. 378-0573-00.

A filter or the faceplate protector should be used at all times to protect the CRT faceplate from scratches. The faceplate protector and the tinted filter mount in the same holder. To remove the light filter or faceplate protector from the holder, press it out to the rear. They can be replaced by snapping them back into the holder.

Beam Finder

The BEAM FINDER provides a means of locating a display which over-scans the viewing area either vertically or horizontally. When the BEAM FINDER switch is pressed, the display is compressed within the graticule area. To locate and re-position an over-scanned display, use the following procedure:

1. Press the BEAM FINDER switch.
2. While the BEAM FINDER switch is held depressed, increase the vertical and horizontal deflection factors until the vertical deflection is reduced to about two divisions and the horizontal deflection is reduced to about four divisions (the horizontal deflection needs to be reduced only when in the X-Y mode of operation).
3. Adjust the vertical and horizontal POSITION controls to center the display about the vertical and horizontal center lines.
4. Release the BEAM FINDER switch; the display should remain within the viewing area.

Vertical Channel Selection

Either of the input channels can be used for single-trace displays. Apply the signal to the desired input connector and set the MODE switch to display the channel used. However, since CH 1 triggering is provided only in Channel 1 and the invert feature only in Channel 2, the correct channel must be selected to take advantage of these features. For dual-trace displays, connect the signals to both input connectors and set the MODE switch to one of the dual-trace positions.

Vertical Gain Adjustment

To check the gain of either channel, set the VOLTS/DIV switch to 20 mV. Set the CALIBRATOR switch to .1 V and connect the 1 kHz CAL connector to the input of the channel used. The vertical deflection should be exactly five divisions. If not, adjust the front-panel GAIN adjustment for exactly five divisions of deflection.

NOTE

If the gain of the two channels must be closely matched (such as for ADD mode operation), the adjustment procedure given in the Calibration section should be used.

The best measurement accuracy when using probes is provided if the GAIN adjustment is made with the probes installed (set the CALIBRATOR switch to 1 V). This compensates for any inaccuracies of the probes. Also, to provide the most accurate measurements, calibrate the vertical gain of the 453A at the temperature at which the measurement is to be made.

Step Attenuator Balance

To check the step attenuator balance of either channel, set the Input Coupling switch to GND and set the A SWEEP MODE switch to AUTO TRIG to provide a free-running trace. Change the VOLTS/DIV switch from 20 mV to 5 mV. If the trace moves vertically, adjust the front-panel STEP ATTEN BAL adjustment as follows (allow at least 10 minutes warmup before performing this adjustment).

1. With the Input Coupling switch set to GND and the VOLTS/DIV switch set to 20 mV, move the trace to the center horizontal line of the graticule with the vertical POSITION control.

2. Set the VOLTS/DIV switch to 5 mV and adjust the STEP ATTEN BAL adjustment to return the trace to the center horizontal line.

3. Recheck step attenuator balance and repeat adjustment until no trace shift occurs as the VOLTS/DIV switch is changed from 20 mV to 5 mV.

Signal Connections

In general, probes offer the most convenient means of connecting a signal to the input of the 453A. Tektronix 10X probes are also shielded to prevent pickup of electrostatic interference. A 10X attenuator probe offers a high input impedance and allows the circuit under test to perform very close to normal operating conditions. However, a 10X probe also attenuates the input signal 10 times. Tektronix Field Effect Transistor probe systems are available which offer the same high-input impedance as the 10X probes. However, they are particularly useful since they provide wide-band operation while presenting low attenuation and low input capacitance. To obtain maximum bandwidth when using probes, observe the grounding considerations given in the probe manual. The probe-to-connector

adapters and the bayonet-ground tip provide the best frequency response. Remember that a ground strap only a few inches in length can produce several percent of ringing when operating at the higher frequency limit of this system. See your Tektronix, Inc. catalog for characteristics and compatibility of probes for use with this system.

In high-frequency applications requiring maximum overall bandwidth, use coaxial cables terminated at both ends in their characteristic impedance. See the discussion on coaxial cables in this section for more information.

High-level, low-frequency signals can be connected directly to the 453A input connectors with short unshielded leads. This coupling method works best for signals below about one kilohertz and deflection factors above one volt/division. When this method is used, establish a common ground between the 453A and the equipment under test. Attempt to position the leads away from any source of interference to avoid errors in the display. If interference is excessive with unshielded leads, use a coaxial cable or a probe.

Loading Effect of the 453A

As nearly as possible, simulate actual operating conditions in the equipment under test. Otherwise, the equipment under test may not produce a normal signal. The probes mentioned previously offer the least circuit loading. See the probe instruction manual for loading characteristics of individual probes.

When the signal is coupled directly to the input of the 453A, the input impedance is about one megohm paralleled by about 20 picofarads. When the signal is coupled to the input through a coaxial cable, the effective input capacitance depends upon the type and length of cable used. See the following discussion for information on obtaining maximum frequency response with coaxial cables.

Coaxial Cable Considerations

The signal cables used to connect the signal to the 453A input connectors have a large effect on the accuracy of a displayed high-frequency waveform. To maintain the high-frequency characteristics of the applied signal, high-quality low-loss coaxial cable should be used. The cable should be terminated at the 453A input connector in its characteristic impedance. If it is necessary to use cables with differing characteristic impedances, use suitable impedance-matching devices to provide the correct transition, with minimum loss, from one impedance to the other.

The characteristic impedance, velocity of propagation, and nature of signal losses in a coaxial cable are determined

by the physical and electrical characteristics of the cable. Losses caused by energy dissipation in the dielectric are proportional to the signal frequency. Therefore, much of the high-frequency information in a fast-rise pulse can be lost in only a few feet of interconnecting cable if it is not the correct type. To be sure of the high-frequency response of the system when using cables longer than about five feet, observe the transient response of the 453A and the interconnecting cable with a fast-rise pulse generator (generator risetime less than 0.5 nanoseconds).

Ground Considerations

Reliable signal measurements cannot be made unless both the oscilloscope and the unit under test are connected together by a common reference (ground) lead in addition to the signal lead or probe. Although the three-wire AC power cord provides a common connection when used with equipment with similar power cords, the ground loop produced may make accurate measurements impossible. The ground straps supplied with the probes provide an adequate ground. The shield of a coaxial cable provides a common ground when connected between two coaxial connectors (or with suitable adapters to provide a common ground). When using unshielded signal leads, a common ground lead should be connected from the 453A chassis to the chassis of the equipment under test.

Input Coupling

The Channel 1 and 2 Input Coupling switches allow a choice of input coupling methods. The type of display desired and the applied signal will determine the coupling to use.

The DC Coupling position can be used for most applications. This position allows measurement of the DC component of a signal. It must also be used to display signals below about 16 hertz as they will be attenuated in the AC position.

In the AC Coupling position, the DC component of the signal is blocked by a capacitor in the input circuit. The low-frequency response in the AC position is about 1.6 hertz (−3 dB point). Therefore, some low-frequency attenuation can be expected near this frequency limit. Attenuation in the form of waveform tilt will also appear in square waves which have low-frequency components. The AC coupling position provides the best display of signals with a DC component which is much larger than the AC component.

The GND position provides a ground reference at the input of the 453A without the need to externally ground the input connectors. The signal applied to the input con-

ductor is internally disconnected, but not grounded, and the input circuit is held at ground potential.

The GND position can also be used to pre-charge the coupling capacitor to the average voltage level of the signal applied to the input connector. This allows measurement of only the AC component of signals having both AC and DC components. The pre-charging network incorporated in this unit allows the input-coupling capacitor to charge to the DC source voltage level when the Input Coupling switch is set to GND. The procedure for using this feature is as follows:

1. Before connecting the signal containing a DC component to the 453A input connector, set the Input Coupling switch to GND. Then connect the signal to the input connector.
2. Wait about one second for the coupling capacitor to charge.
3. Set the Input Coupling switch to AC. The trace (display) should remain on the screen so the AC component of the signal can be measured in the normal manner.

Deflection Factor

The amount of vertical deflection produced by a signal is determined by the signal amplitude, the attenuation factor of the probe (if used), the setting of the VOLTS/DIV switch, and the setting of the VAR VOLTS/DIV control. The calibrated deflection factors indicated by the VOLTS/DIV switches apply only when the VAR control is set to the calibrated position (fully counterclockwise).

The VAR VOLTS/DIV control provides variable (uncalibrated) vertical deflection between the calibrated settings of the VOLTS/DIV switch. The VAR control extends the maximum vertical deflection factor of the 453A to at least 25 volts/division (10 volts position).

Dual-Trace Operation

Alternate Mode. The ALT position of the vertical MODE switch produces a display which alternates between Channel 1 and 2 with each sweep of the CRT. Although the ALT mode can be used at all sweep rates, the CHOP mode provides a more satisfactory display at sweep rates below about 50 microseconds/division. At these slower sweep rates, alternate mode switching becomes visually perceptible.

Proper internal triggering in the ALT mode can be obtained in either the NORM or CH 1 OR X-Y positions of the INT TRIG switch. When in the NORM position, the

Operating Instructions—453A/R453A

sweep is triggered from the signal on each channel. This provides a stable display of two unrelated signals, but does not indicate the time relationship between the signals. In the CH 1 OR X-Y position, the two signals are displayed showing true time relationship. If the signals are not time related, the Channel 2 waveform will be unstable in the CH 1 OR X-Y position.

Chopped Mode. The CHOP position of the MODE switch produces a display which is electronically switched between channels. In general, the CHOP mode provides the best display at sweep rates lower than about 50 microseconds/division, or whenever dual-trace, single-shot phenomena are to be displayed. At faster sweep rates the chopped switching becomes apparent and may interfere with the display.

Proper internal triggering for the CHOP mode is provided with the INT TRIG switch set to CH 1 OR X-Y. If the NORM position is used, the sweep circuits are triggered from the between-channel switching signal and both waveforms will be unstable. External triggering provides the same result as CH 1 OR X-Y triggering.

Two signals which are time-related can be displayed in the chopped mode showing true time relationship. If the signals are not time-related, the Channel 2 display will appear unstable. Two single-shot, transient, or random signals which occur within the time interval determined by the TIME/DIV switch (10 times sweep rate) can be compared using the CHOP mode. To correctly trigger the sweep for maximum resolution, the Channel 1 signal must precede the Channel 2 signal. Since the signals show true time relationship, time-difference measurements can be made.

Channel 1 Output and Cascaded Operation

If a lower deflection factor than provided by the VOLTS/DIV switches is desired, Channel 1 can be used as a wide-band preamplifier for Channel 2. Apply the input signal to the CH 1 OR X connector. Connect a 50-ohm BNC cable (18-inch cable for maximum cascaded frequency response) between the CH 1 OUT (side panel) and the CH 2 OR Y connectors. Set the MODE switch to CH 2 and the INT TRIG switch to NORM. With both VOLTS/DIV switches set to 5 mV, the deflection factor will be less than one millivolt/division.

To provide calibrated one millivolt/division deflection factor, connect the .1-volt Calibrator signal to the CH 1 OR X connector. Set the CH 1 VOLTS/DIV switch to .1 and the CH 2 VOLTS/DIV switch to 5 mV. Adjust the Channel 2 VAR VOLTS/DIV control to produce a display exactly five divisions in amplitude. The cascaded deflection factor is determined by dividing the CH 1 VOLTS/DIV switch

setting by 5 (CH 2 VOLTS/DIV switch and VAR control remain as set above). For example, with the CH 1 VOLTS/DIV switch set to 5 mV, the calibrated deflection factor will be 1 millivolt/division; CH 1 VOLTS/DIV switch set to 10 mV, 2 millivolts/division, etc.

The following operating considerations and basic applications may suggest other uses for this feature.

1. If AC coupling is desired, set the Channel 1 Input Coupling switch to AC and leave the Channel 2 Input Coupling switch set to DC. When both Input Coupling switches are set to DC, DC signal coupling is provided.

2. Keep both vertical POSITION controls set near mid-range. If the input signal has a DC level which necessitates one of the POSITION controls being turned away from midrange, correct operation can be obtained by keeping the Channel 1 POSITION control near midrange and using the Channel 2 POSITION control to position the trace near the desired location. Then, use the Channel 1 POSITION control for exact positioning. This method will keep both Input Preamps operating in their linear range.

3. The output voltage at the CH 1 OUT connector is at least 25 millivolts/division of CRT display in all CH 1 VOLTS/DIV switch positions.

4. The MODE switch and Channel 1 VAR VOLTS/DIV control have no effect on the signal available at the CH 1 OUT connector.

5. The Channel 1 Input Preamp can be used as an impedance matching stage with or without voltage gain. The input resistance is one megohm and the output resistance is about 50 ohms.

6. The dynamic range of the Channel 1 Input Preamp is equal to about 20 times the CH 1 VOLTS/DIV setting. The CH 1 OUT signal is nominally at 0 volt DC for a 0 volt DC input level (Channel 1 POSITION control centered). The Channel 1 POSITION control can be used to center the output signal within the dynamic range of the amplifier.

7. If dual-trace operation is used, the signal applied to the Channel 1 input connector is displayed when Channel 1 is turned on. When Channel 2 is turned on, the amplified signal is displayed. Thus, Channel 1 trace can be used to monitor the input signal while the amplified signal is displayed by Channel 2.

8. In special applications where the flat frequency response of the 453A is not desired, a filter inserted between the CH 1 OUT and CH 2 OR Y connector allows the oscilloscope to essentially take on the frequency response of the filter. Combined with method 7, the input can be monitored by Channel 1 and the filtered signal displayed by Channel 2.

9. By using Channel 1 as a 5X low-level voltage pre-amplifier (5 mV position), the Channel 1 signal available at the CH 1 OUT connector can be used for any application where a low-impedance preamplified signal is needed. Remember that if a 50-ohm load impedance is used, the signal amplitude will be about one-half.

Algebraic Addition

General. The ADD position of the MODE switch can be used to display the sum or difference of two signals, for common-mode rejection to remove an undesired signal, or for DC offset (applying a DC voltage to one channel to offset the DC component of a signal on the other channel).

The common-mode rejection ratio of the 453A is greater than 20:1 at one kilohertz (at all deflection factors) for signal amplitudes up to eight times the VOLTS/DIV switch setting. Higher rejection ratios can typically be achieved by careful adjustment of the gain of either channel while observing the displayed common-mode signal.

Deflection Factor. The overall deflection factor in the ADD position of the MODE switch when both VOLTS/DIV switches are set to the same position is the same as the deflection factor indicated by either VOLTS/DIV switch. The amplitude of an added mode display can be determined directly from the resultant CRT deflection multiplied by the deflection factor indicated by either VOLTS/DIV switch. However, if the CH 1 and CH 2 VOLTS/DIV switches are set to different deflection factors, resultant voltage is difficult to determine from the CRT display. In this case, the voltage amplitude of the resultant display can be determined accurately only if the amplitude of the signal applied to either channel is known.

Precautions. The following general precautions should be observed when using the ADD mode.

1. Do not exceed the input voltage rating of the 453A.
2. Do not apply signals that exceed an equivalent of about 20 times the VOLTS/DIV switch setting. For example, with a VOLTS/DIV switch setting of .5, the voltage applied to that channel should not exceed about 10 volts. Larger voltages may distort the display.

3. Use vertical POSITION control settings which most nearly position the signal of each channel to mid-screen when viewed in either the CH 1 or CH 2 positions of the MODE switch. This insures the greatest dynamic range for ADD mode operation.

4. For similar response from each channel, set both Input Coupling switches to the same position.

Trigger Source

INT. For most applications, the sweep can be triggered internally. In the INT position of the Triggering SOURCE switch, the trigger signal is obtained from the Vertical Deflection System. The INT TRIG switch provides further selection of the internal trigger signal; obtained from the Channel 1 signal in the CH 1 OR X-Y position, or from the displayed signal when in the NORM position. For single-trace displays of either channel, the NORM position provides the most convenient operation. However, for dual-trace displays special considerations must be made to provide the correct display. See Dual-Trace Operation in this section for dual-trace triggering information.

LINE. The LINE position of the SOURCE switch connects a sample of the power-line frequency to the Trigger Generator circuit. Line triggering is useful when the input signal is time-related to the line frequency. It is also useful for providing a stable display of a line-frequency component in a complex waveform.

EXT. An external signal connected to the EXT TRIG INPUT connector can be used to trigger the sweep in the EXT position of the Triggering SOURCE switch. The external signal must be time-related to the displayed signal for a stable display. An external trigger signal can be used to provide a triggered display when the internal signal is too low in amplitude for correct triggering, or contains signal components on which it is not desired to trigger. It is also useful when signal tracing in amplifiers, phase-shift networks, waveshaping circuits, etc. The signal from a single point in the circuit under test can be connected to the EXT TRIG INPUT connector through a signal probe or cable. The sweep is then triggered by the same signal at all times and allows amplitude, time relationship or waveshape changes of signals at various points in the circuit to be examined without resetting the trigger controls.

EXT ÷ 10. Operation in the EXT ÷ 10 position is the same as described for EXT except that the external triggering signal is attenuated 10 times. Attenuation of high-amplitude external triggering signals is desirable to broaden the range of the Triggering LEVEL control. When the COUPLING switch is set to LF REJ, attenuation is about 20:1.

Trigger Coupling

General. Four methods of coupling the trigger signal to the trigger circuits can be selected with the Triggering COUPLING switches. Each position permits selection or rejection of the frequency components of the trigger signal which can trigger the sweep. Fig. 2-8 graphically illustrates the band of frequencies covered by each position of the COUPLING switch.

AC. The AC position blocks the DC component of the trigger signal. Signals with low-frequency components below about 30 hertz are attenuated. In general, AC coupling can be used for most applications. However, if the trigger signal contains unwanted components or if the sweep is to be triggered at a low repetition rate or a DC level, one of the remaining COUPLING switch positions will provide a better display.

The triggering point in the AC position depends on the average voltage level of the trigger signal. If the trigger signals occur in a random fashion, the average voltage level will vary, causing the triggering point to vary also. This shift of the triggering point may be enough so it is impossible to maintain a stable display. In such cases, use DC coupling.

LF REJ. In the LF REJ position, DC is rejected and signals below about 30 kilohertz are attenuated. Therefore, the sweep will be triggered only by the higher-frequency components of the signal. This position is particularly useful for providing stable triggering if the trigger signal contains line-frequency components. Also, in the ALT position of the MODE switch, the LF REJ position provides the best display at high sweep rates when comparing two unrelated signals (INT TRIG switch set to NORM).

HF REJ. The HF REJ position passes all low-frequency signals between about 30 hertz and 50 kilohertz. DC is rejected and signals outside the given range are attenuated. When triggering from complex waveforms, this position is useful for providing stable display of low-frequency components.

DC. DC coupling can be used to provide stable triggering with low-frequency signals which would be attenuated in the AC position, or with low-repetition rate signals. It can also be used to trigger the sweep when the trigger signal reaches a DC level selected by the setting of the LEVEL control. When using internal triggering, the setting of the Channel 1 and 2 POSITION controls affects the DC trigger level.

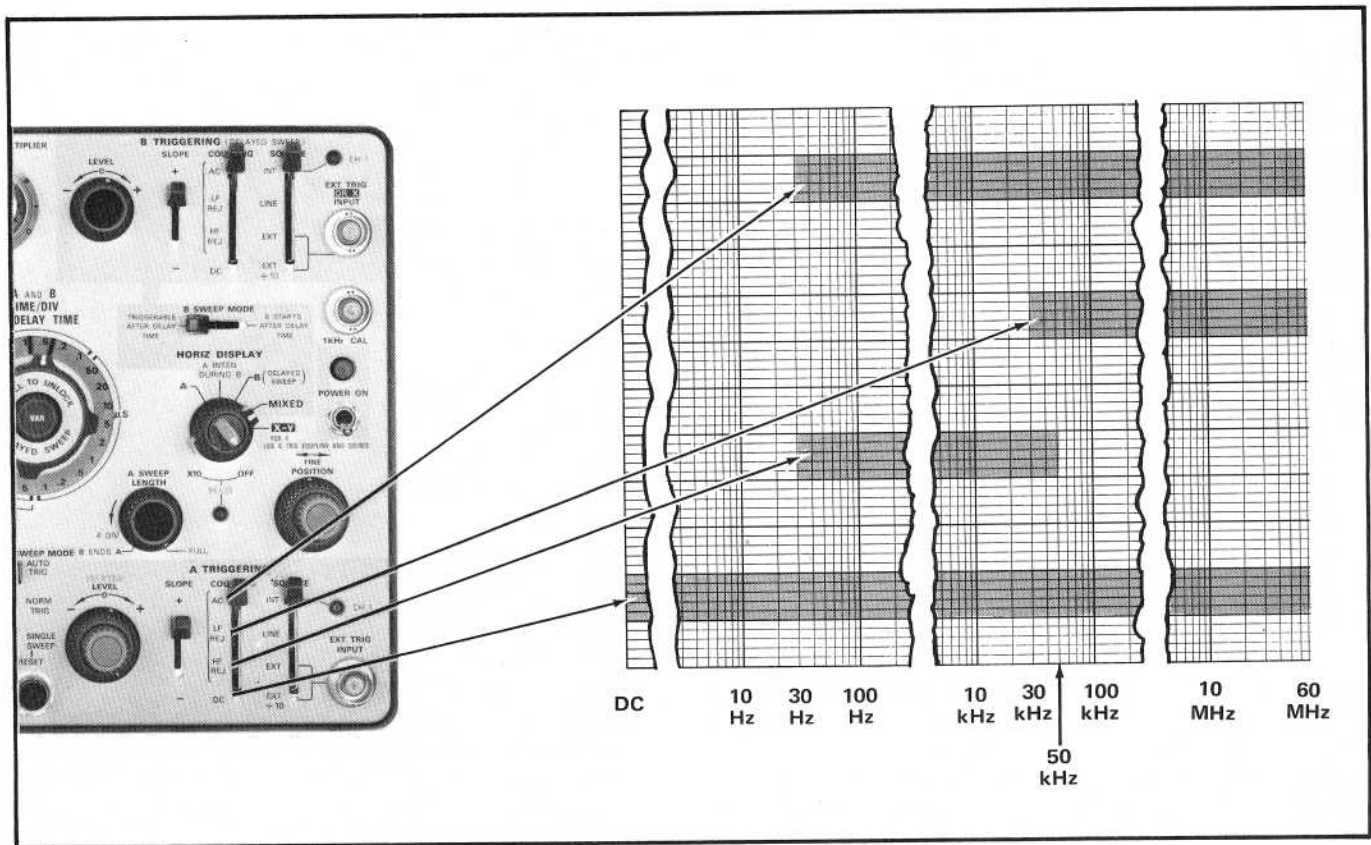


Fig. 2-8. Frequency range of each COUPLING switch position.

DC trigger coupling should not be used in the ALT dual-trace mode if the INT TRIG switch is set to NORM. If used, the sweep will trigger on the DC level of one trace and then either lock out completely or free run on the other trace. Correct DC triggering for this mode can be obtained with the INT TRIG switch set to CH 1 OR X-Y.

Trigger Slope

The triggering SLOPE switch determines whether the trigger circuit responds on the positive-going or negative-going portion of the trigger signal. When the SLOPE switch is in the + (positive-going) position, the display starts with the positive-going portion of the waveform; in the - (negative-going) position, the display starts with the negative-going portion of the waveform (see Fig. 2-9). When several cycles of a signal appear in the display, the setting of the SLOPE switch is often unimportant. However, if only a certain portion of a cycle is to be displayed, correct setting of the SLOPE switch is important to provide a display which starts on the desired slope of the input signal.

Trigger Level

The Triggering LEVEL control determines the voltage level on the trigger signal at which the sweep is triggered. When the LEVEL control is set in the + region, the trigger circuit responds at a more positive point on the trigger signal. When the LEVEL control is set in the - region, the trigger circuit responds at a more negative point on the trigger signal. Fig. 2-9 illustrates this effect with different settings of the SLOPE switch.

To set the LEVEL control, first select the Triggering MODE, SOURCE, COUPLING, and SLOPE. Then set the LEVEL control fully counterclockwise and rotate it clockwise until the display starts at the desired point.

High-Frequency Stability

The HF STAB control (A only) is used to provide a stable display of high-frequency signals. If a stable display cannot be obtained using the A LEVEL control (trigger signal must have adequate amplitude), adjust the HF STAB control for minimum horizontal jitter in the display. This control has little effect with low-frequency signals.

A Sweep Triggered Light

The A SWEEP TRIG'D light provides a convenient indication of the condition of the A Triggering circuit. If the A Triggering controls are correctly adjusted with an adequate trigger signal applied, the light is on. However, if the A LEVEL control is misadjusted, the A COUPLING or A SOURCE switches incorrectly set, or the trigger signal too low in amplitude, the A SWEEP TRIG'D light will be off. This feature can be used as a general indication of correct

triggering. It is particularly useful when setting up the trigger circuits when a trigger signal is available without a trace displayed on the CRT and it also indicates that the A sweep remains correctly triggered when operating in the B (DE-LAYED SWEEP) mode.

A Sweep Mode

AUTO TRIG. The AUTO TRIG position of the A SWEEP MODE switch provides a stable display when the A LEVEL control is correctly set (see Trigger Level in this section) and a trigger signal is available. The A SWEEP TRIG'D light indicates when the A Sweep Generator is triggered.

When the trigger repetition rate is less than about 20 hertz, or in the absence of an adequate trigger signal, the A Sweep Generator free runs to produce a reference trace. When an adequate trigger signal is again applied, the free-running condition ends and the A Sweep Generator is triggered to produce a stable display (with correct A LEVEL control setting).

NORM TRIG. Operation in the NORM TRIG position when a trigger signal is applied is the same as in the AUTO TRIG position. However, when a trigger signal is not present, the A Sweep Generator remains off and there is no display. The A SWEEP TRIG'D light indicates when the A sweep is triggered. The NORM TRIG mode can be used to display signals with repetition rates below about 20 hertz. This mode provides an indication of an adequate trigger signal as well as the correctness of trigger control settings, since there is no display without proper triggering. Also, the A SWEEP TRIG'D light is off when the A sweep is not correctly triggered.

SINGLE SWEEP. When the signal to be displayed is not repetitive or varies in amplitude, shape, or time, a conventional repetitive display may produce an unstable presentation. To avoid this, use the single-sweep feature of the 453A. The SINGLE SWEEP mode can also be used to photograph a non-repetitive signal.

To use the SINGLE SWEEP mode, first make sure the trigger circuit will respond to the event to be displayed. Set the A SWEEP MODE switch to AUTO TRIG or NORM TRIG and obtain the best possible display in the normal manner (for random signals, set the trigger circuit to trigger on a signal which is approximately the same amplitude and frequency as the random signal). Then, set the A SWEEP MODE switch to SINGLE SWEEP and press the RESET button. When the RESET button is pushed, the next trigger pulse initiates the sweep and a single trace will be presented on the screen. After this sweep is complete, the A Sweep Generator is "locked out" until reset. The RESET light

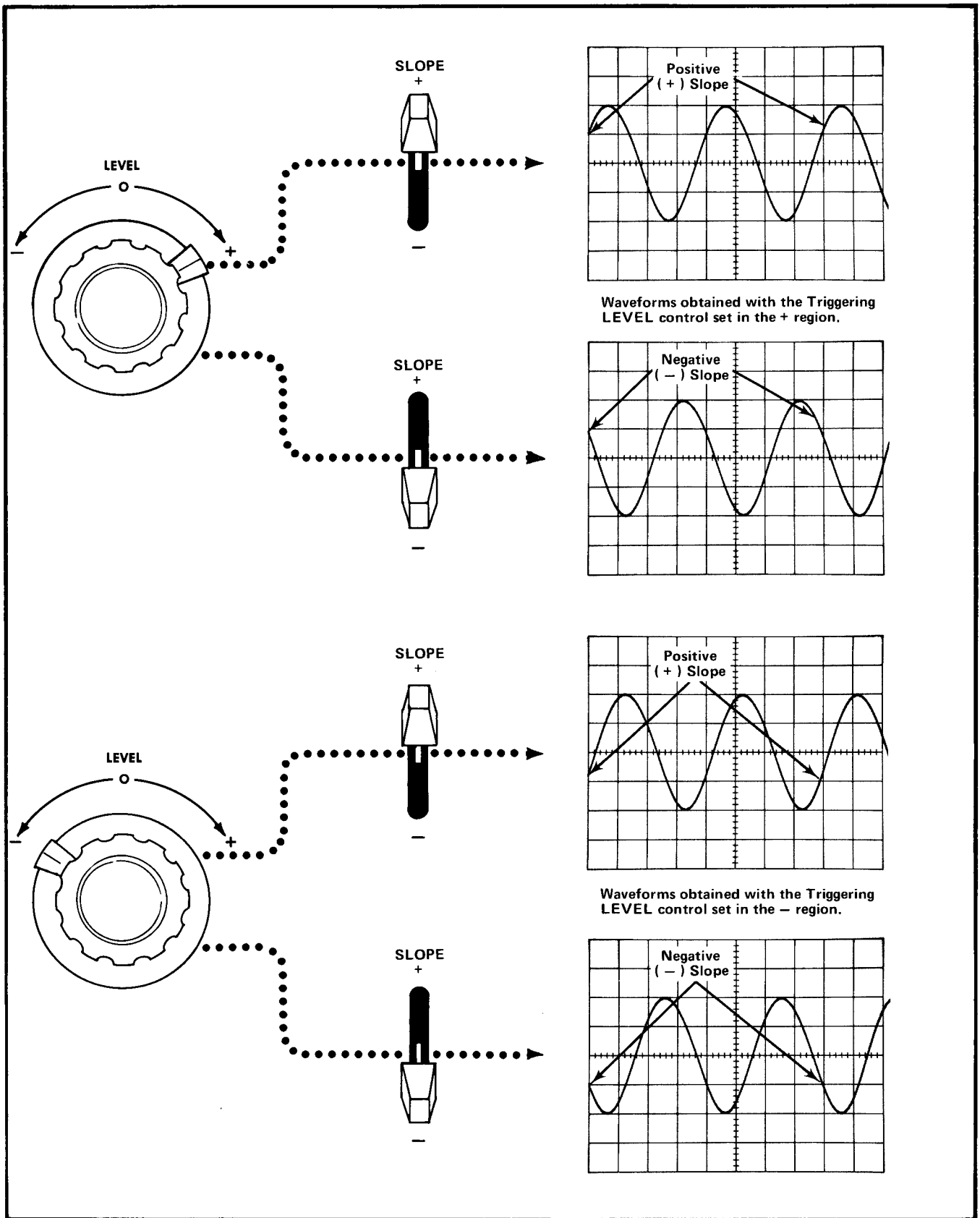


Fig. 2-9. Effects of Triggerring LEVEL control and SLOPE switch.

located inside the RESET button is on when the A Sweep Generator circuit has been reset and is ready to produce a sweep; it goes out after the sweep is complete. To prepare the circuit for another single-sweep display, press the RESET button again.

Horizontal Sweep Rate

The A AND B TIME/DIV switches select calibrated sweep rates for the Sweep Generators. The A VAR and B VARIABLE controls provide continuously variable sweep rates between the settings of the TIME/DIV switches. Whenever the UNCAL A OR B light is on, the sweep rate of either A or B Sweep Generator, or both, is uncalibrated. The light is off when the A VAR (front panel) and B TIME/DIV VARIABLE (side panel) controls are both set to the calibrated position.

The sweep rate of the A Sweep Generator is bracketed by the two black lines on the clear plastic flange of the TIME/DIV switch (see Fig. 2-10). The sweep rate of the B Sweep Generator is indicated by the dot on the DELAYED SWEEP knob. When the dot on the outer knob is set to the same position as the lines on the inner knob, the two knobs lock together and the sweep rate of both Sweep Generators is changed at the same time. However, when the DELAYED SWEEP knob is pulled outward, the clear plastic flange is disengaged and only the B Sweep Generator sweep rate is changed. This allows changing the delayed sweep rate without changing the delay time determined by the A Sweep Generator.

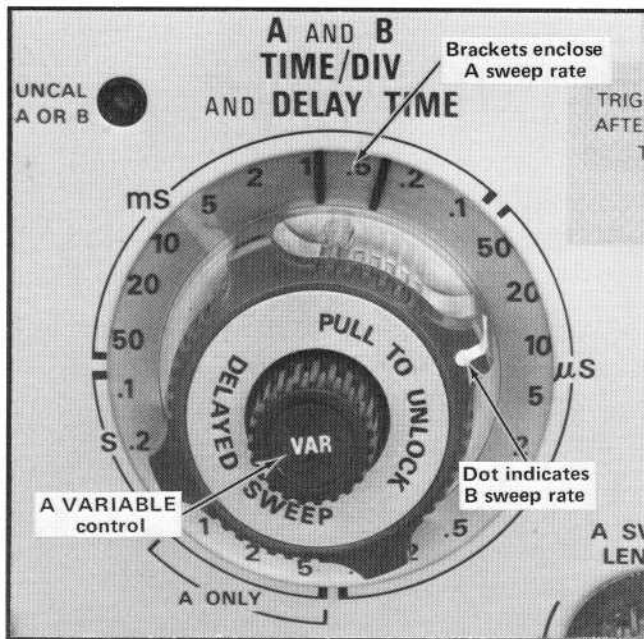


Fig. 2-10. A AND B TIME/DIV switch.

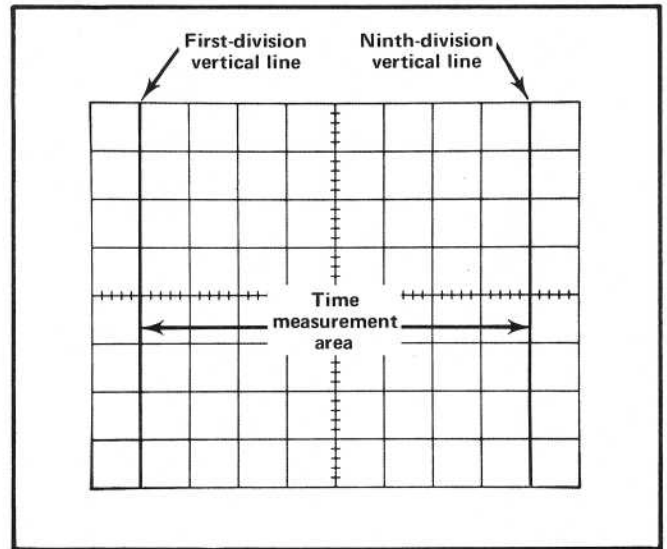


Fig. 2-11. Area of graticule used for accurate time measurements.

When making time measurements from the graticule, the area between the first-division and ninth-division vertical lines provides the most linear time measurement (see Fig. 2-11). Therefore, the first and last division of the display should not be used for making accurate time measurements. Position the start of the timing area to the first-division vertical line and set the TIME/DIV switch so the end of the timing area falls between the first- and ninth-division vertical lines.

Sweep Magnification

The sweep magnifier expands the sweep 10 times. The center division of the unmagnified display is the portion visible on the screen in magnified form (see Fig. 2-12). Equivalent length of the magnified sweep is about 100 divisions; any 10-division portion may be viewed by adjusting the horizontal POSITION control to bring the desired portion onto the viewing area. The FINE position control is particularly useful when the magnifier is on, as it provides positioning in small increments for more precise control.

To use the magnified sweep, first move the portion of the display which is to be expanded to the center of the graticule. Then set the MAG switch to X10. The FINE position control can be adjusted to position the magnified display as desired. The light located below the MAG switch is on whenever the magnifier is on.

When the MAG switch is set to X10, the sweep rate is determined by dividing the TIME/DIV switch setting by 10. For example, if the TIME/DIV switch is set to $.5 \mu\text{s}$, the magnified sweep rate is $0.05 \mu\text{s/division}$. The magnified sweep rate must be used for all time measure-

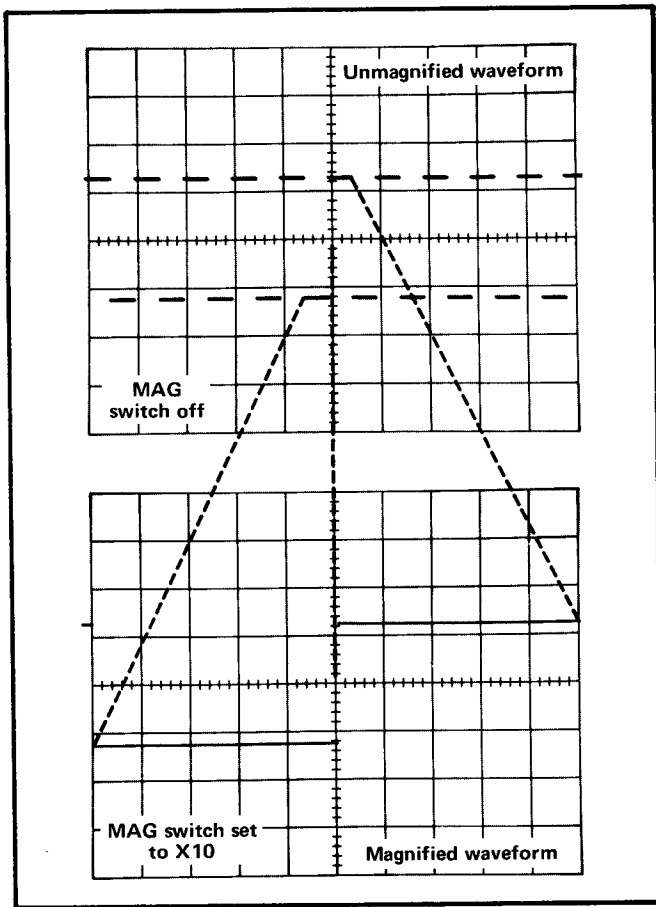


Fig. 2-12. Operation of sweep magnifier.

ments when the MAG switch is set to X10. The magnified sweep rate is calibrated when the UNCAL A OR B light is off.

Mixed and Delayed Sweep

The delayed sweep (B sweep) is operable in the A INTEN DURING B, B (DELAYED SWEEP), and MIXED positions of the HORIZ DISPLAY switch. The A sweep rate along with the DELAY-TIME MULTIPLIER dial setting determines the time that the B sweep is delayed. Sweep rate of the delayed portion is determined by the B TIME/DIV (DELAYED SWEEP) switch setting.

In the A INTEN DURING B position, the display will appear similar to Fig. 2-13A. The amount of delay time between the start of A sweep and the intensified portion is determined by the setting of the A TIME/DIV switch and the DELAY-TIME MULTIPLIER dial.

For example, the delay indicated by the DELAY-TIME MULTIPLIER dial setting shown in Fig. 2-14 is 3.55; this

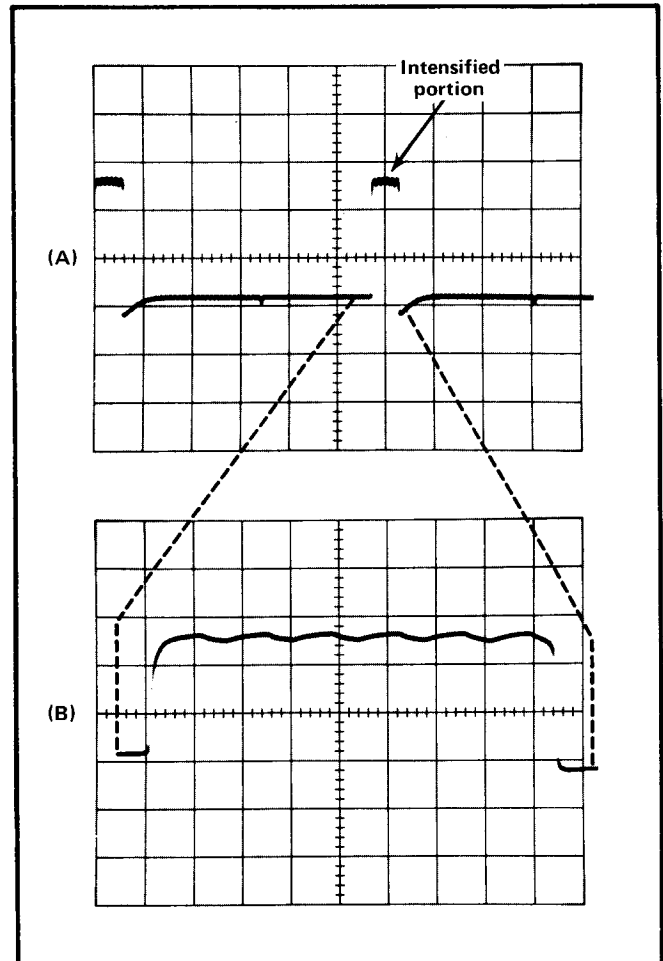


Fig. 2-13. (A) A INTEN DURING B display (A TIME/DIV, .5 ms; B TIME/DIV, 50 μ s), (B) B (DELAYED SWEEP) display.

corresponds to 3.55 CRT divisions of A sweep. This reading multiplied by the setting of the A TIME/DIV switch gives the calibrated delay time before the start of the B sweep (see B Sweep Mode which follows). The intensified portion of the display is produced by the B sweep. The length of this portion is about 10 times the setting of the B TIME/DIV switch.

When the HORIZ DISPLAY switch is set to B (DELAYED SWEEP), only the intensified portion which was shown in the A INTEN DURING B position is displayed on the screen at the sweep rate indicated by the B TIME/DIV switch (see Fig. 2-13B).

The MIXED position of the HORIZ DISPLAY switch provides a CRT display containing more than one time factor on the horizontal axis. The first part of the display is at the sweep rate set by the A TIME/DIV switch and for the time duration determined by the setting of the DELAY-TIME MULTIPLIER dial. The latter part of the display is at

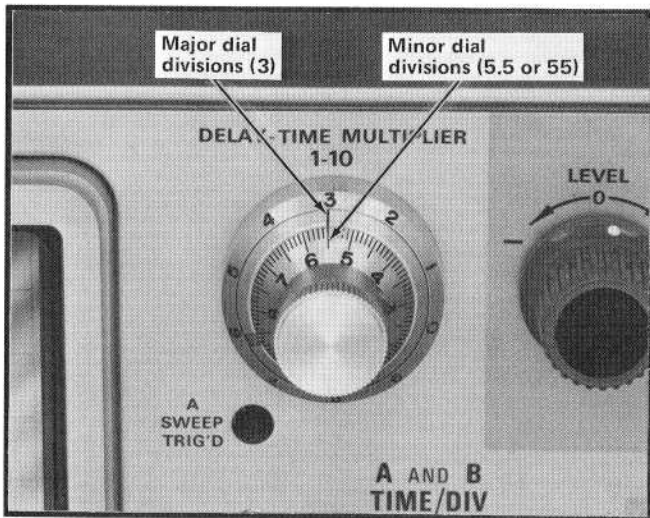


Fig. 2-14. DELAY-TIME MULTIPLIER dial. Reading shown: 3.55.

the sweep rate set by the B TIME/DIV switch. Fig. 2-15 illustrates a typical mixed sweep display.

B Sweep Mode. The B SWEEP MODE switch provides two modes of delayed sweep operation. Fig. 2-16 illustrates the difference between these two modes. In the B STARTS AFTER DELAY TIME position, the B sweep is presented immediately after the delay time (see Fig. 2-16A). The B sweep is triggered at a selected point on A sweep to provide the delay time (B sweep essentially free running). Since the delay time is the same for each sweep, the display appears stable. In the TRIGGERABLE AFTER DELAY TIME position, the B sweep operates only when it is triggered (by Trigger Circuits) after the selected delay time (see Fig.

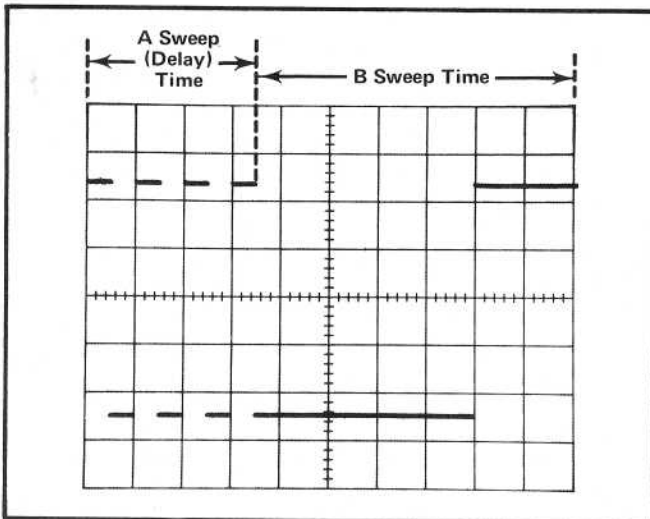


Fig. 2-15. A typical mixed sweep display (A TIME/DIV set to 1 ms, B TIME/DIV set to .1 ms, and the DELAY-TIME MULTIPLIER dial set to 3.55).

2-16B). The B Triggering controls operate as described in this section.

Delayed Sweep Operation. To obtain a delayed sweep display, use the following procedure.

1. Obtain a stable display with the HORIZ DISPLAY switch set to A.
2. Set the HORIZ DISPLAY switch to A INTEN DURING B.
3. Set the B SWEEP MODE switch to the desired setting. If TRIGGERABLE AFTER DELAY TIME is selected, correct B Triggering is also necessary.

4. Set the delay time with the A TIME/DIV switch and the DELAY-TIME MULTIPLIER dial.

5. Pull the DELAYED SWEEP (B TIME/DIV) knob out and set to the desired sweep rate.

6. If the TRIGGERABLE AFTER DELAY TIME position is used, check the display for an intensified portion. Absence of the intensified zone indicates that B sweep is not correctly triggered.

7. Set the HORIZ DISPLAY switch to B (DELAYED SWEEP). The intensified zone shown in the A INTEN DURING B position is now displayed at the sweep rate selected by the B TIME/DIV switch.

Several examples using the delayed sweep feature are given under Basic Applications in this section.

Mixed Sweep Operation. To obtain a mixed sweep display, use the following procedure:

1. Follow the procedure given above for Delayed Sweep Operation.

2. Set the HORIZ DISPLAY switch to MIXED. The first part of the display is at the sweep rate set by the A TIME/DIV switch. The last part is at the sweep rate of the B TIME/DIV switch. The DELAY-TIME MULTIPLIER dial determines the point that the sweep rate changes from A to B.

A Sweep Length. The A SWEEP LENGTH control is most useful when used with delayed sweep. As the control is rotated counterclockwise from the FULL position, the length of the A sweep decreases (sweep rate remains constant) until it is about four divisions long in the counter-

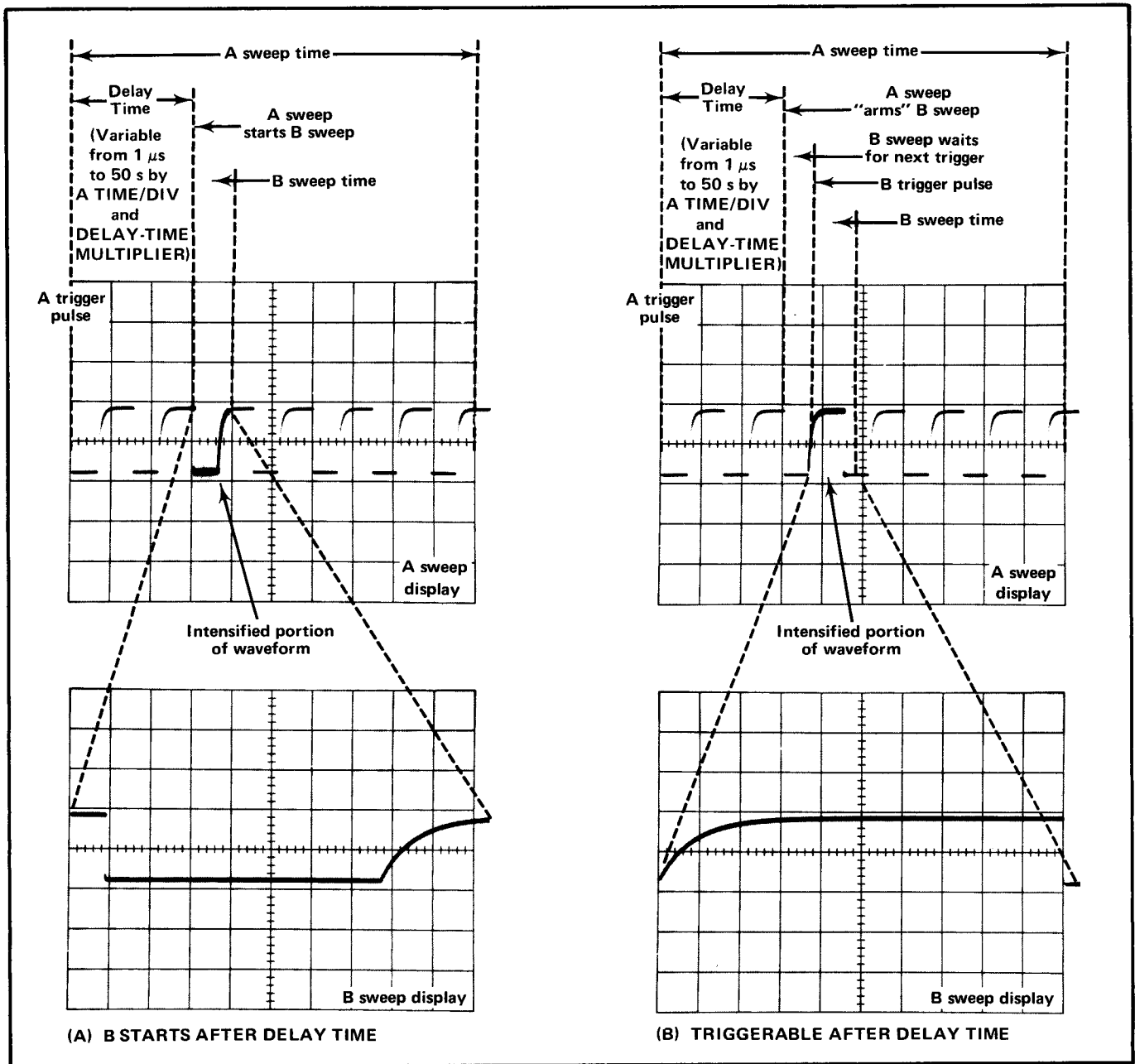


Fig. 2-16. Comparison of delayed-sweep modes. (A) B STARTS AFTER DELAY TIME, (B) TRIGGERABLE AFTER DELAY TIME. In each display the B sweep is delayed a selected amount of time by the A sweep.

clockwise position (not in B ENDS A detent). The B ENDS A position produces a display which ends immediately following B sweep if the B sweep ends before the normal end of A sweep. The A SWEEP LENGTH control is used to increase the repetition rate of delayed sweep displays.

To use the A SWEEP LENGTH control, set the HORIZ DISPLAY switch to A INTEN DURING B and set the delay

time and delayed sweep rate in the normal manner. Turn the A SWEEP LENGTH control counterclockwise until the sweep ends immediately following the intensified portion on the display. Now set the HORIZ DISPLAY switch to B (DELAYED SWEEP). This method provides the maximum repetition rate for a given delayed sweep display. In the B ENDS A position, the maximum delayed sweep repetition rate is maintained automatically.

NOTE

Jitter can be introduced into the display and incorrect displays produced through the wrong usage of the A SWEEP LENGTH control. When using this control, first obtain the best possible display in the FULL position. Then, set the control for the desired A sweep length. If jitter is evident in the display, readjust the Triggering controls or change the A SWEEP LENGTH control to a position that does not cause jitter.

X-Y Operation

In some applications, it is desirable to display one signal versus another (X-Y) rather than against time (internal sweep). The X-Y position of the HORIZ DISPLAY switch provides a means for applying an external signal to the horizontal amplifier for this type of display.

Two modes of external horizontal operation are provided. When the INT TRIG switch is set to CH 1 OR X-Y, the B SOURCE switch to INT, and the B COUPLING switch to DC, the horizontal deflection is provided by a signal applied to the CH 1 OR X connector. The CH 1 VOLTS/DIV switch setting indicates the calibrated horizontal deflection factor (Channel 1 VAR control inoperative). Center the horizontal POSITION control and use the Channel 1 POSITION control for horizontal positioning.

In the EXT and $EXT \div 10$ positions of the B SOURCE switch, external horizontal deflection is provided by a signal applied to the B EXT TRIG OR X INPUT connector. The signal coupling provided by the B COUPLING switch can be used to select or reject components of the external horizontal signal (all components of external horizontal signal accepted in DC position). Using this mode of operation, the horizontal deflection factor is uncalibrated. External horizontal deflection factor is about 270 millivolts/division in the EXT position of the B SOURCE switch and about 2.7 volts/division in the $EXT \div 10$ position.

For further information on obtaining and interpreting lissajous displays, refer to the reference books listed under Applications.

A and B Gate

The A and B GATE output connectors (on side panel) provide a rectangular output pulse which is coincident with the sweep time of the respective sweep generator. This rectangular pulse is about +12 volts in amplitude (into high-impedance loads) with pulse duration the same as the respective sweep.

Intensity Modulation

Intensity (Z-axis) modulation can be used to relate a third item of electrical phenomena to the vertical (Y-axis) and the horizontal (X-axis) coordinates without affecting the waveshape of the displayed signal. The Z-axis modulating signal applied to the CRT circuit changes the intensity of the displayed waveform to provide this type of display. "Gray scale" intensity modulation can be obtained by applying signals which do not completely blank the display. Large amplitude signals of the correct polarity will completely blank the display; the sharpest display is provided by signals with a fast rise and fall. The voltage amplitude required for visible trace modulation depends upon the setting of the INTENSITY control. At normal intensity level, a five-volt peak-to-peak signal produces a visible change in brightness. When the Z AXIS INPUT is not in use, keep the ground strap in place to prevent changes in trace intensity due to extraneous noise.

Time markers applied to the Z AXIS INPUT connector provide a direct time reference on the display. With uncalibrated horizontal sweep or external horizontal mode operation, the time markers provide a means of reading time directly from the display. However, if the markers are not time-related to the displayed waveform, a single-sweep display should be used (for internal sweep only) to provide a stable display.

Calibrator

General. The one-kilohertz square-wave Calibrator of the 453A provides a convenient signal source for checking basic vertical gain and sweep timing. However, to provide maximum measurement accuracy, the adjustment procedure given in the Calibration section of this manual should be used. The Calibrator output signal is also very useful for adjusting probe compensation as described in the probe instruction manual. In addition, the Calibrator can be used as a convenient signal source for application to external equipment.

Voltage. The Calibrator provides accurate peak-to-peak square-wave voltages of 0.1 and 1 volt into a high impedance load. Voltage range is selected by the CALIBRATOR switch on the side panel. Output resistance is about 200 ohms in the 1 V position and about 20 ohms in the 0.1 V position. The actual voltage across an external load resistor can be calculated in the same manner as with any series resistor combination (necessary only if the load resistance is less than about 50 kilohms).

Current. The current loop, located on the side panel, provides a five milliamper peak-to-peak square-wave current which can be used to check and calibrate current-measuring probe systems. This current signal is obtained by clipping the probe around the current loop. Current is con-

Operating Instructions—453A/R453A

start through the loop in either position of the CALIBRATOR switch. The arrow above the PROBE LOOP indicates conventional current flow; i.e., from + to —.

Frequency. The Calibrator circuit uses frequency-stable components to maintain accurate frequency and constant duty cycle. Thus the Calibrator can be used for checking the basic sweep timing of the horizontal system.

Waveshape. The square-wave output signal of the Calibrator can be used as a reference waveshape when checking or adjusting the compensation of passive, high-resistance probes. Since the square-wave output from the Calibrator has a flat top, any distortion in the displayed waveform is due to the probe compensation.

APPLICATIONS

General

The following information describes the procedures and techniques for making measurements with a 453A Oscilloscope. These applications are not described in detail, since each application must be adapted to the requirements of the individual measurement. This instrument can also be used for many applications which are not described in this manual. Contact your local Tektronix Field Office or representative for assistance in making specific measurements with this instrument.

The following books describe oscilloscope measurement techniques which can be adapted for use with this instrument.

Harley Carter, "An Introduction to the Cathode Ray Oscilloscope", Philips Technical Library, Cleaver-Hume Press Ltd., London, 1960.

J. Czech, "Oscilloscope Measuring Technique", Philips Technical Library, Springer-Verlag, New York, 1965.

Robert G. Middleton, "Scope Waveform Analysis", Howard W. Sams & Co. Inc., The Bobbs-Merrill Company Inc., Indianapolis, 1963.

Robert G. Middleton and L. Donald Payne, "Using the Oscilloscope in Industrial Electronics", Howard W. Sams & Co. Inc., The Bobbs-Merrill Company Inc., Indianapolis, 1961.

John F. Rider and Seymour D. Uslan, "Encyclopedia of Cathode-Ray Oscilloscopes and Their Uses", John F. Rider Publisher Inc., New York, 1959.

John F. Rider, "Obtaining and Interpreting Test Scope Traces", John F. Rider Publisher Inc., New York, 1959.

Rufus P. Turner, "Practical Oscilloscope Handbook", Volumes 1 and 2, John F. Rider Publisher Inc., New York, 1964.

Peak-to-Peak Voltage Measurements—AC

To make a peak-to-peak voltage measurement, use the following procedure:

1. Connect the signal to either input connector.
2. Set the MODE switch to display the channel used.
3. Set the VOLTS/DIV switch to display about five divisions of the waveform.
4. Set the Input Coupling switch to AC.

NOTE

For low-frequency signals below about 16 hertz, use the DC position.

5. Set the A Triggering controls to obtain a stable display. Set the TIME/DIV switch to a position that displays several cycles of the waveform.

6. Turn the vertical POSITION control so the lower portion of the waveform coincides with one of the graticule lines below the center horizontal line, and the top of the waveform is on the viewing area. Move the display with the horizontal POSITION control so one of the upper peaks lies near the center vertical line (see Fig. 2-17).

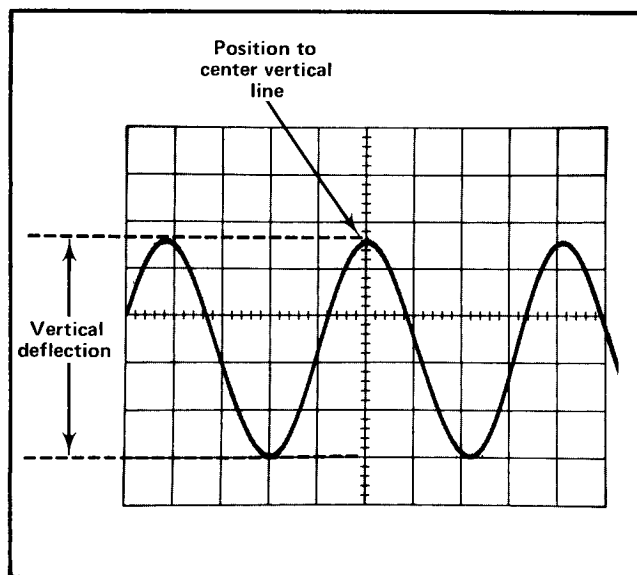


Fig. 2-17. Measuring peak-to-peak voltage of a waveform.

7. Measure the divisions of vertical deflection from peak to peak. Make sure the VAR VOLTS/DIV control is in the calibrated position.

NOTE

This technique may also be used to make measurements between two points on the waveform rather than peak to peak.

8. Multiply the distance measured in step 7 by the VOLTS/DIV switch setting. Also include the attenuation factor of the probe, if any.

Example. Assume a peak-to-peak vertical deflection of 4.6 divisions (see Fig. 2-17) using a 10X attenuator probe and a VOLTS/DIV switch setting of .5.

Using the formula:

$$\text{Volts Peak to Peak} = \text{vertical deflection (divisions)} \times \text{VOLTS/DIV setting} \times \text{probe attenuation factor}$$

Substituting the given values:

$$\text{Volts Peak to Peak} = 4.6 \times 0.5 \text{ V} \times 10$$

The peak-to-peak voltage is 23 volts.

Instantaneous Voltage Measurements—DC

To measure the DC level at a given point on a waveform, use the following procedure:

1. Connect the signal to either input connector.
2. Set the MODE switch to display the channel used.
3. Set the VOLTS/DIV switch to display about five divisions of the waveform.
4. Set the Input Coupling switch to GND.
5. Set the A SWEEP MODE switch to AUTO TRIG.
6. Position the trace to the bottom line of the graticule or other reference line. If the voltage is negative with respect to ground, position the trace to the top line of the graticule. Do not move the vertical POSITION control after this reference line has been established.

NOTE

To measure a voltage level with respect to a voltage rather than ground, make the following changes in step 6. Set the Input Coupling switch to DC and apply the reference voltage to the INPUT connector. Then position the trace to the reference line.

7. Set the Input Coupling switch to DC. The ground reference line can be checked at any time by switching to the GND position (except when using a DC reference voltage).

8. Set the A Triggering controls to obtain a stable display. Set the TIME/DIV switch to a setting that displays several cycles of the signal.

9. Measure the distance in divisions between the reference line and the point on the waveform at which the DC level is to be measured. For example, in Fig. 2-18 the measurement is made between the reference line and point A.

10. Establish the polarity of the signal. If the waveform is above the reference line, the voltage is positive; below the line, negative (when the INVERT switch is pushed in if using Channel 2).

11. Multiply the distance measured in step 9 by the VOLTS/DIV switch setting. Include the attenuation factor of the probe, if any.

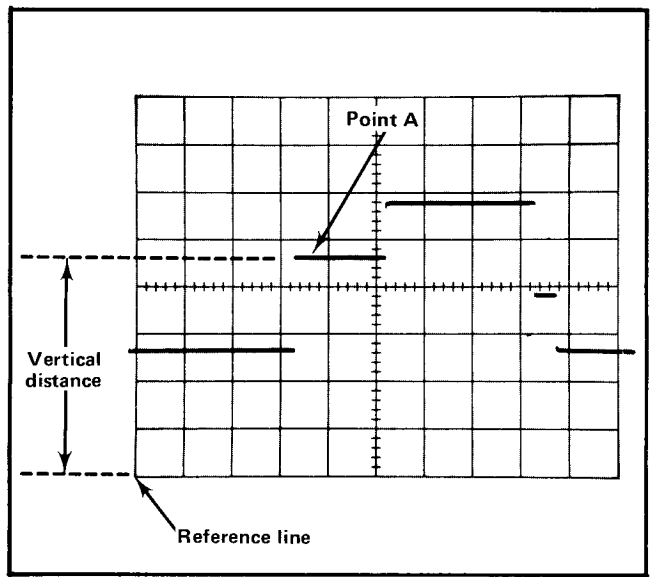


Fig. 2-18. Measuring instantaneous DC voltage with respect to a reference.

Example. Assume that the vertical distance measured is 4.6 divisions (see Fig. 2-18), the waveform is above the reference line, using a 10X attenuator probe and a VOLTS/DIV setting of 2.

Using the formula:

$$\text{Instantaneous Voltage} = \text{vertical distance (divisions)} \times \text{polarity} \times \text{VOLTS/DIV setting} \times \text{probe attenuation factor}$$

Substituting the given values:

$$\text{Instantaneous Voltage} = 4.6 \times +1 \times 2 \text{ V} \times 10$$

The instantaneous voltage is +92 volts.

Comparison Measurements

General. In some applications it may be desirable to establish arbitrary units of measure other than those indicated by the VOLTS/DIV switch or TIME/DIV switch. This is particularly useful when comparing unknown signals to a reference amplitude or repetition rate. One use for the comparison-measurement technique is to facilitate calibration of equipment (e.g., on an assembly-line test) where the desired amplitude or repetition rate does not produce an exact number of divisions of deflection. The adjustment will be easier and more accurate if arbitrary units of measure are established so that correct adjustment is indicated by an exact number of divisions of deflection. Arbitrary sweep rates can be useful for comparing harmonic signals to a fundamental frequency, or for comparing the repetition rate of the input and output pulses in a digital count-down circuit. The following procedure describes how to establish arbitrary units of measure for comparison measurements. Although the procedure for establishing vertical and horizontal arbitrary units of measure is much the same, both processes are described in detail.

Vertical Deflection Factor. To establish an arbitrary vertical deflection factor based upon a specific reference amplitude, proceed as follows:

1. Connect the reference signal to the input connector. Set the TIME/DIV switch to display several cycles of the signal.

2. Set the VOLTS/DIV switch and the VAR VOLTS/DIV control to produce a display an exact number of graticule divisions in amplitude. Do not change the VAR VOLTS/DIV control after obtaining the desired deflection. This display can be used as a reference for amplitude comparison measurements.

3. To establish an arbitrary vertical deflection factor so the amplitude of an unknown signal can be measured accurately at any setting of the VOLTS/DIV switch, the amplitude of the reference signal must be known. If it is not known, it can be measured before the VAR VOLTS/DIV control is set in step 2.

4. Divide the amplitude of the reference signal (volts) by the product of the vertical deflection established in step 2 (divisions) and the setting of the VOLTS/DIV switch. This is the vertical conversion factor.

$$\text{Vertical Conversion Factor} = \frac{\text{reference signal amplitude (volts)}}{\text{vertical deflection (divisions)} \times \text{VOLTS/DIV switch setting}}$$

5. To measure the amplitude of an unknown signal, disconnect the reference signal and connect the unknown signal to the input connector. Set the VOLTS/DIV switch to a setting that provides sufficient vertical deflection to make an accurate measurement. Do not readjust the VAR VOLTS/DIV control.

6. Measure the vertical deflection in divisions and calculate the amplitude of the unknown signal using the following formula.

$$\text{Signal Amplitude} = \text{VOLTS/DIV switch setting} \times \text{vertical conversion factor} \times \text{vertical deflection (divisions)}$$

EXAMPLE: Assume a reference signal amplitude of 30 volts, a VOLTS/DIV switch setting of 5 and the VAR VOLTS/DIV control is adjusted to provide a vertical deflection of four divisions.

Substituting these values in the vertical conversion factor formula (step 4):

$$\text{Vertical Conversion Factor} = \frac{30 \text{ V}}{4 \times 5 \text{ V}} = 1.5$$

Then, with a VOLTS/DIV switch setting of 10, the peak-to-peak amplitude of an unknown signal which produces a vertical deflection of five divisions can be determined by using the signal amplitude formula (step 6):

$$\text{Signal Amplitude} = 10 \text{ V} \times 1.5 \times 5 = 75 \text{ volts}$$

Sweep Rates. To establish an arbitrary horizontal sweep rate based upon a specific reference frequency, proceed as follows:

1. Connect the reference signal to the input connector. Set the VOLTS/DIV switch for four or five divisions of vertical deflection.

2. Set the TIME/DIV switch and the A VAR TIME/DIV control so one cycle of the signal covers an exact number of horizontal divisions. Do not change the A VAR TIME/DIV control after obtaining the desired deflection. This display can be used as a reference for frequency comparison measurements.

3. To establish an arbitrary sweep rate so the repetition rate of an unknown signal can be measured accurately at any setting of the TIME/DIV switch, the repetition rate of the reference signal must be known. If it is not known, it can be measured before the A VAR TIME/DIV switch is set in step 2.

4. Divide the repetition rate of the reference signal (seconds) by the product of the horizontal deflection established in step 2 (divisions) and the setting of the TIME/DIV switch. This is the horizontal conversion factor.

$$\text{Horizontal Conversion Factor} = \frac{\text{reference signal repetition rate (seconds)}}{\text{horizontal deflection (divisions)} \times \text{TIME/DIV switch setting}}$$

5. To measure the repetition rate of an unknown signal, disconnect the reference signal and connect the unknown signal to the input connector. Set the TIME/DIV switch to a setting that provides sufficient horizontal deflection to make an accurate measurement. Do not readjust the A VAR TIME/DIV control.

6. Measure the horizontal deflection in divisions and calculate the repetition rate of the unknown signal using the following formula:

$$\text{Repetition Rate} = \text{TIME/DIV switch setting} \times \text{horizontal conversion factor} \times \text{horizontal deflection (divisions)}$$

NOTE

If the horizontal magnifier is used, be sure to use the magnified sweep rate in place of the TIME/DIV switch setting.

EXAMPLE: Assume a reference signal frequency of 455 hertz (repetition rate 2.19 milliseconds), and a TIME/DIV switch setting of .2 ms, with the A VAR TIME/DIV control adjusted to provide a horizontal deflection of eight divisions. Substituting these values in the horizontal conversion factor formula (step 4):

$$\text{Horizontal Conversion Factor} = \frac{2.19 \text{ ms}}{0.2 \text{ ms} \times 8} = 1.37$$

Then, with a TIME/DIV switch setting of 50 μs, the repetition rate of an unknown signal which completes one cycle in seven horizontal divisions can be determined by using the repetition rate formula (step 6):

$$\text{Repetition Rate} = 50 \mu\text{s} \times 1.37 \times 7 = 480 \mu\text{s}$$

This answer can be converted to frequency by taking the reciprocal of the repetition rate (see application on Determining Frequency).

Time-Duration Measurements

To measure time between two points on a waveform, use the following procedure:

1. Connect the signal to either input connector.
2. Set the MODE switch to display the channel used.
3. Set the VOLTS/DIV switch to display about five divisions of the waveform.
4. Set the A Triggering controls to obtain a stable display.
5. Set the TIME/DIV switch to the fastest sweep rate that displays less than eight divisions between the time measurement points (see Fig. 2-19). (See the topic entitled Selecting Sweep Rate in this section concerning non-linearity of first and last divisions of display.)
6. Adjust the vertical POSITION control to move the points between which the time measurement is made to the center horizontal line.
7. Adjust the horizontal POSITION control to center the display within the center eight divisions of the graticule.

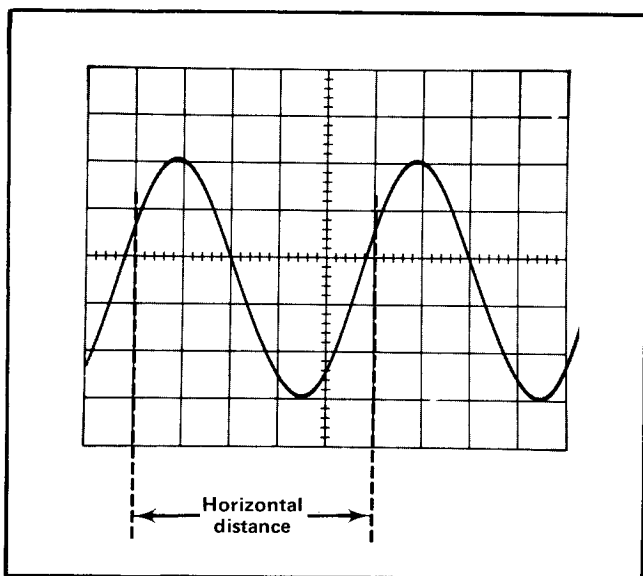


Fig. 2-19. Measuring the time duration between points on a waveform.

8. Measure the horizontal distance between the time measurement points. Be sure the A VAR control is set to the calibrated position.

9. Multiply the distance measured in step 8 by the setting of the TIME/DIV switch. If sweep magnification is used, divide this answer by 10.

Example. Assume that the horizontal distance between the time measurement points is five divisions (see Fig. 2-19) and the TIME/DIV switch is set to .1 ms with the magnifier off.

Using the formula:

$$\text{Time Duration} = \frac{\text{horizontal distance} \times \text{TIME/DIV setting}}{\text{magnification}} \text{ (divisions)}$$

Substituting the given values:

$$\text{Time Duration} = \frac{5 \times 0.1 \text{ ms}}{1}$$

The time duration is 0.5 millisecond.

Determining Frequency

The time measurement technique can also be used to measure the frequency of a signal. The frequency of a

periodically-recurrent signal is the reciprocal of the time duration (period) of one cycle.

Use the following procedure:

1. Measure the time duration of one cycle of the waveform as described in the previous application.
2. Take the reciprocal of the time duration to determine the frequency.

Example. The frequency of the signal shown in Fig. 2-19 which has a time duration of 0.5 millisecond is:

$$\text{Frequency} = \frac{1}{\text{time duration}} = \frac{1}{0.5 \text{ ms}} = 2 \text{ kHz}$$

Risetime Measurements

Risetime measurements employ basically the same techniques as time-duration measurements. The main difference is the points between which the measurement is made. The following procedure gives the basic method of measuring risetime between the 10% and 90% points of the waveform. Falltime can be measured in the same manner on the trailing edge of the waveform.

1. Connect the signal to either input connector.
2. Set the MODE switch to display the channel used.
3. Set the VOLTS/DIV switch and VAR VOLTS/DIV control to produce a display an exact number of divisions in amplitude.
4. Center the display about the center horizontal line.
5. Set the A Triggering controls to obtain a stable display.
6. Set the TIME/DIV switch to the fastest sweep rate that displays less than eight divisions between the 10% and 90% points on the waveform.

7. Determine the 10% and 90% points on the rising portion of the waveform. The figures given in Table 2-2 are for the points 10% up from the start of the rising portion and 10% down from the top of the rising portion (90% point).

TABLE 2-2

Vertical display (divisions)	10% and 90% points	Divisions vertically between 10% & 90% points
4	0.4 and 3.6 divisions	3.2
5	0.5 and 4.5 divisions	4.0
6	0.6 and 5.4 divisions	4.8
7	0.7 and 6.3 divisions	5.6
8	0.8 and 7.2 divisions	6.4

8. Adjust the horizontal POSITION control to move the 10% point of the waveform to the first graticule line. For example, with a five-division display as shown in Fig. 2-20, the 10% point is 0.5 division up from the start of the rising portion.

9. Measure the horizontal distance between the 10% and 90% points. Be sure the A VAR control is set to the calibrated position.

10. Multiply the distance measured in step 8 by the setting of the TIME/DIV switch. If sweep magnification is used, divide this answer by 10.

Example. Assume that the horizontal distance between the 10% and 90% points is four divisions (see Fig. 2-20) and the TIME/DIV switch is set to 1 μs with the MAG switch set to X10.

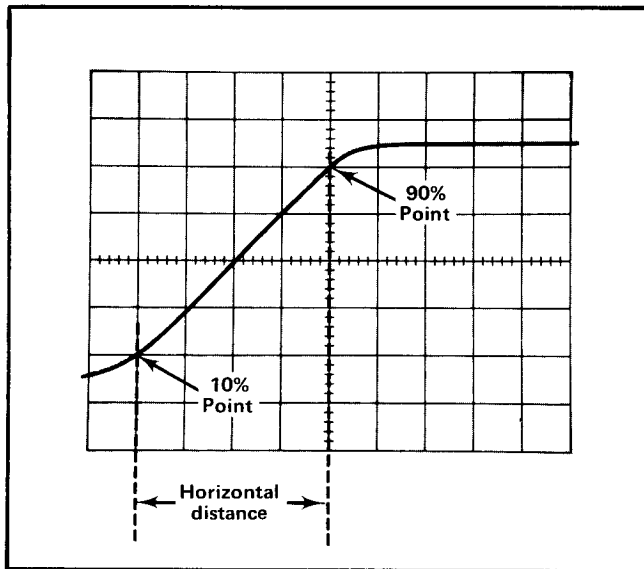


Fig. 2-20. Measuring risetime.

Applying the time duration formula to risetime:

$$\text{Risetime (Time Duration)} = \frac{\text{horizontal distance (divisions)} \times \text{TIME/DIV setting}}{\text{magnification}}$$

Substituting the given values:

$$\text{Risetime} = \frac{4 \times 1 \mu\text{s}}{10}$$

The risetime is 0.4 microsecond.

Time-Difference Measurements

The calibrated sweep rate and dual-trace features of the 453A allow measurement of time difference between two separate events. To measure time difference, use the following procedure.

1. Set the Input Coupling switches to the desired coupling positions.

2. Set the MODE switch to either CHOP or ALT. In general, CHOP is more suitable for low-frequency signals and the ALT position is more suitable for high-frequency signals. More information on determining the mode is given under Dual-Trace Operation in this section.

3. Set the INT TRIG switch to CH 1 OR X-Y.

4. Connect the reference signal to the CH 1 OR X connector and the comparison signal to CH 2 OR Y connector. The reference signal should precede the comparison signal in time. Use coaxial cables or probes which have equal time delay to connect the signals to the input connectors.

5. If the signals are of opposite polarity, pull out the INVERT switch to invert the Channel 2 display (signal may be of opposite polarity due to 180° time difference; if so take into account in final calculation).

6. Set the VOLTS/DIV switches to produce four or five-division displays.

7. Set the A LEVEL control for a stable display.

8. If possible, set the TIME/DIV switch for a sweep rate which shows three or more divisions between the two waveforms.

9. Adjust the vertical POSITION controls to center each waveform (or the points on the display between which the measurement is made) in relation to the center horizontal line.

10. Adjust the horizontal POSITION control so the Channel 1 (reference) waveform crosses the center horizontal line at a vertical graticule line.

11. Measure the horizontal difference between the Channel 1 waveform and the Channel 2 waveform (see Fig. 2-21).

12. Multiply the measured difference by the setting of the TIME/DIV switch. If sweep magnification is used, divide this answer by 10.

Example. Assume that the TIME/DIV switch is set to 50 μ s, the MAG switch to X10, and the horizontal difference between waveforms is 4.5 divisions (see Fig. 2-21).

Using the formula:

$$\text{Time Delay} = \frac{\text{TIME/DIV setting} \times \text{horizontal difference (divisions)}}{\text{magnification}}$$

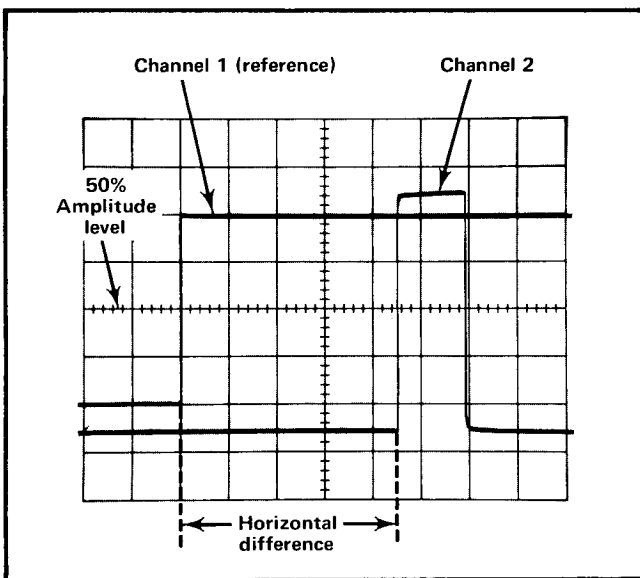


Fig. 2-21. Measuring time difference between two pulses.

Substituting the given values:

$$\text{Time Delay} = \frac{50 \mu\text{s} \times 4.5}{10}$$

The time delay is 22.5 microseconds.

NOTE

Do not use the MIXED position of the HORIZ DISPLAY switch to make time measurements with the DELAY-TIME MULTIPLIER dial. In this mode, error is introduced into the measurement due to the special relationship between the A and B sweeps.

Delayed Sweep Time Measurements

The delayed sweep mode can be used to make accurate time measurements. The following measurement determines the time difference between two pulses displayed on the same trace. This application may also be used to measure time difference from two different sources (dual-trace) or to measure time duration of a single pulse. See Section 1 for measurement accuracy.

1. Connect the signal to either input connector. Set the MODE switch to display the channel used.
2. Set the VOLTS/DIV switch to produce a display about four divisions in amplitude.
3. Adjust the A Triggering controls for a stable display.
4. If possible, set the A TIME/DIV switch to a sweep rate which displays about eight divisions between the pulses.
5. Set the HORIZ DISPLAY switch to A INTEN DURING B and the B SWEEP MODE switch to B STARTS AFTER DELAY TIME.
6. Set the B TIME/DIV switch to a setting 1/100th of the A TIME/DIV sweep rate. This produces an intensified portion about 0.1 division in length.

NOTE

Do not change the A LEVEL control setting or the horizontal POSITION control setting in the following steps as the measurement accuracy will be affected.

7. Turn the DELAY-TIME MULTIPLIER dial to move the intensified portion to the first pulse.

8. Set the HORIZ DISPLAY switch to B (DELAYED SWEEP).

9. Adjust the DELAY-TIME MULTIPLIER dial to move the pulse (or the rising portion) to the center vertical line. Note the setting of the DELAY-TIME MULTIPLIER dial.

10. Turn the DELAY-TIME MULTIPLIER dial clockwise until the second pulse is positioned to this same point (if several pulses are displayed, return to the A INTEN DURING B position to locate the correct pulse). Again note the dial setting.

11. Subtract the first dial setting from the second and multiply by the delay time shown by the A TIME/DIV switch. This is the time interval between the pulses.

Example. Assume the first dial setting is 1.31 and the second dial setting is 8.81 with the A TIME/DIV switch set to 0.2 microsecond (see Fig. 2-22).

Using the formula:

$$\text{Time Difference (delayed sweep)} = \left[\begin{array}{cc} \text{second} & \text{first} \\ \text{dial} & \text{dial} \\ \text{setting} & \text{setting} \end{array} \right] \times \begin{array}{c} \text{delay time} \\ \text{(A TIME/DIV} \\ \text{setting)} \end{array}$$

Substituting the given values:

$$\text{Time Difference} = [8.81 - 1.31] \times 0.2 \mu\text{s}$$

The time difference is 1.5 microseconds.

Delayed Sweep Magnification

The delayed sweep feature of the 453A can be used to provide higher apparent magnification than is provided by the MAG switch. The sweep rate of the DELAYED SWEEP (B sweep) is not actually increased; the apparent magnification is the result of delaying the B sweep an amount of time selected by the A TIME/DIV switch and the DELAY-TIME MULTIPLIER dial before the display is presented at the sweep rate selected by the B TIME/DIV switch. The following methods use the B STARTS AFTER DELAY TIME position to allow the delayed portion to be positioned with the DELAY-TIME MULTIPLIER dial. If there is too much jitter in the delayed display, use the Triggered Delayed Sweep Magnification procedure.

1. Connect the signal to either input connector. Set the MODE switch to display the channel used.

2. Set the VOLTS/DIV switch to produce a display about 4 divisions in amplitude.

3. Adjust the A Triggering controls for a stable display.

4. Set the A TIME/DIV switch to a sweep rate which displays the complete waveform.

5. Set the HORIZ DISPLAY switch to A INTEN DURING B and the B SWEEP MODE switch to B STARTS AFTER DELAY TIME.

6. Position the start of the intensified portion with the DELAY-TIME MULTIPLIER dial to the part of the display to be magnified.

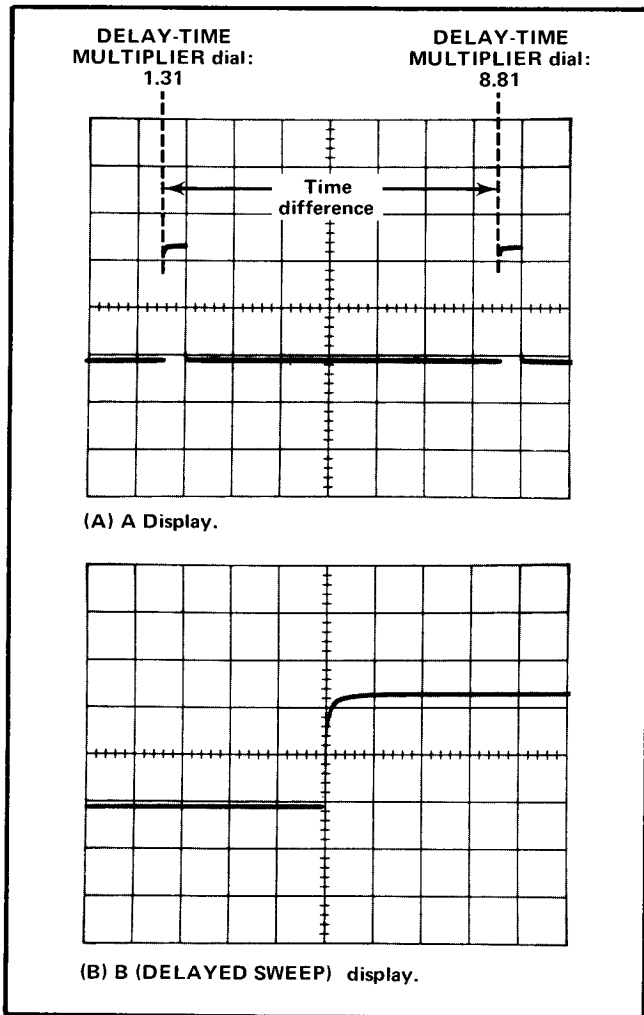


Fig. 2-22. Measuring time difference using delayed sweep.

Operating Instructions—453A/R453A

7. Set the B TIME/DIV switch to a setting which intensifies the full portion to be magnified. The start of the intensified trace will remain as positioned above.

8. Set the HORIZ DISPLAY switch to B (DELAYED SWEEP).

9. Time measurements can be made from the display in the conventional manner. Sweep rate is determined by the setting of the B TIME/DIV switch.

10. The apparent sweep magnification can be calculated by dividing the A TIME/DIV switch setting by the B TIME/DIV switch setting.

Example. The apparent magnification of the display shown in Fig. 2-23 with an A TIME/DIV switch setting of .1 ms and a B TIME/DIV switch setting of 1 μ s is:

$$\text{Apparent Magnification (delayed sweep)} = \frac{\text{A TIME/DIV setting}}{\text{B TIME/DIV setting}}$$

Substituting the given values:

$$\text{Apparent Magnification} = \frac{1 \times 10^{-4}}{1 \times 10^{-6}}$$

The apparent magnification is 100 times.

Triggered Delayed Sweep Magnification. The delayed sweep magnification method just described may produce too much jitter at high apparent magnification ranges. The TRIGGERABLE AFTER DELAY TIME position of the B SWEEP MODE switch provides a more stable display since the delayed display is triggered at the same point each time.

1. Set up the display as given in steps 1 through 7 described above.

2. Set the B SWEEP MODE switch to TRIGGERABLE AFTER DELAY TIME.

3. Adjust the B LEVEL control so the intensified portion on the trace is stable. (If an intensified portion cannot be obtained, see step 4.)

4. Inability to intensify the desired portion indicates that the B Triggering controls are incorrectly set or the signal does not meet the triggering requirements. If the con-

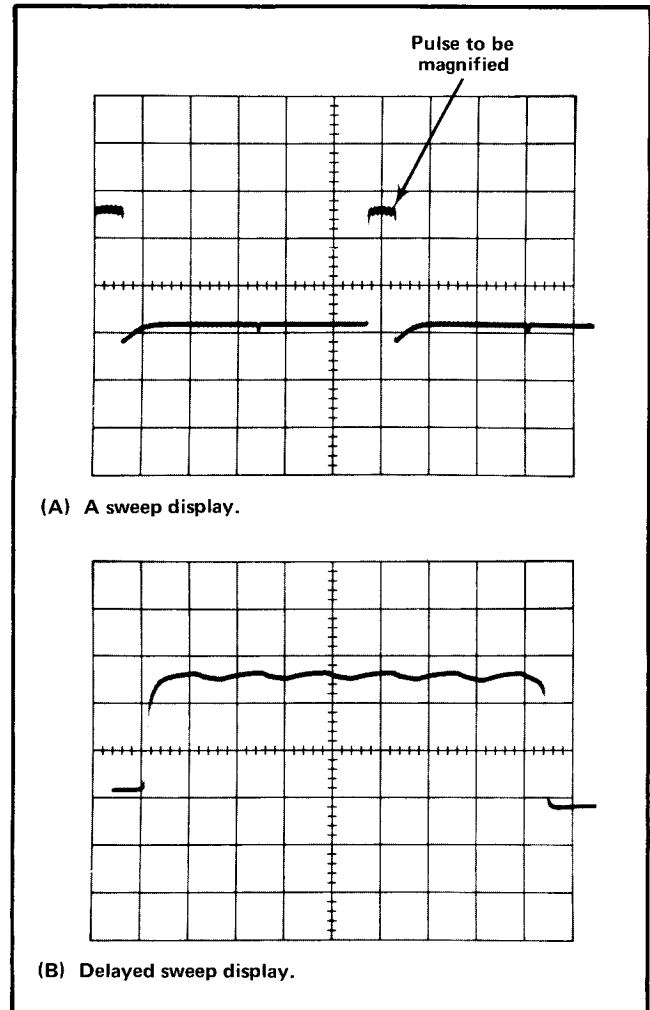


Fig. 2-23. Using delayed sweep for sweep magnification.

dition cannot be remedied with the B Triggering controls or by increasing the display amplitude (lower VOLTS/DIV setting), externally trigger the B sweep.

5. When the correct portion is intensified, set the HORIZ DISPLAY switch to B (DELAYED SWEEP). Slight re-adjustment of the B LEVEL control may be necessary for a stable display.

6. Measurement and magnification are as described above.

Displaying Complex Signals Using Delayed Sweep

Complex signals often consist of a number of individual events of differing amplitudes. Since the trigger circuits are sensitive to changes in signal amplitude, a stable display can normally be obtained only when the sweep is triggered by

the event(s) having the greatest amplitude. However, this may not produce the desired display of a lower amplitude event which follows the triggering event. The delayed sweep feature provides a means of delaying the start of the B sweep by a selected amount following the event which triggers the A Sweep Generator. Then, the part of the waveform which contains the information of interest can be displayed.

Use the following procedure:

1. Connect the signal to either input connector. Set the MODE switch to display the channel used.
2. Set the VOLTS/DIV switch to produce a display about four divisions in amplitude.
3. Adjust the A Triggering controls for a stable display.
4. Set the A TIME/DIV switch to a sweep rate which displays the complete waveform.
5. Set the HORIZ DISPLAY switch to A INTEN DURING B and the B SWEEP MODE switch to B STARTS AFTER DELAY TIME.
6. Position the start of the intensified portion with the DELAY-TIME MULTIPLIER dial to the part of the display to be magnified.
7. Set the B TIME/DIV switch to a setting which intensifies the full portion to be magnified. The start of the intensified trace will remain as positioned above.
8. Set the HORIZ DISPLAY switch to B (DELAYED SWEEP).
9. Time measurements can be made from the display in the conventional manner. Sweep rate is determined by the setting of the B TIME/DIV switch.

Example. Fig. 2-24 shows a complex waveform as displayed on the CRT. The circled portion of the waveform cannot be viewed in any greater detail because the sweep is triggered by the larger amplitude pulses at the start of the display, and a faster sweep rate moves this area of the waveform off the viewing area. The second waveform shows the area of interest magnified 10 times using Delayed Sweep. The DELAY-TIME MULTIPLIER dial has been adjusted so the delayed sweep starts just before the area of interest.

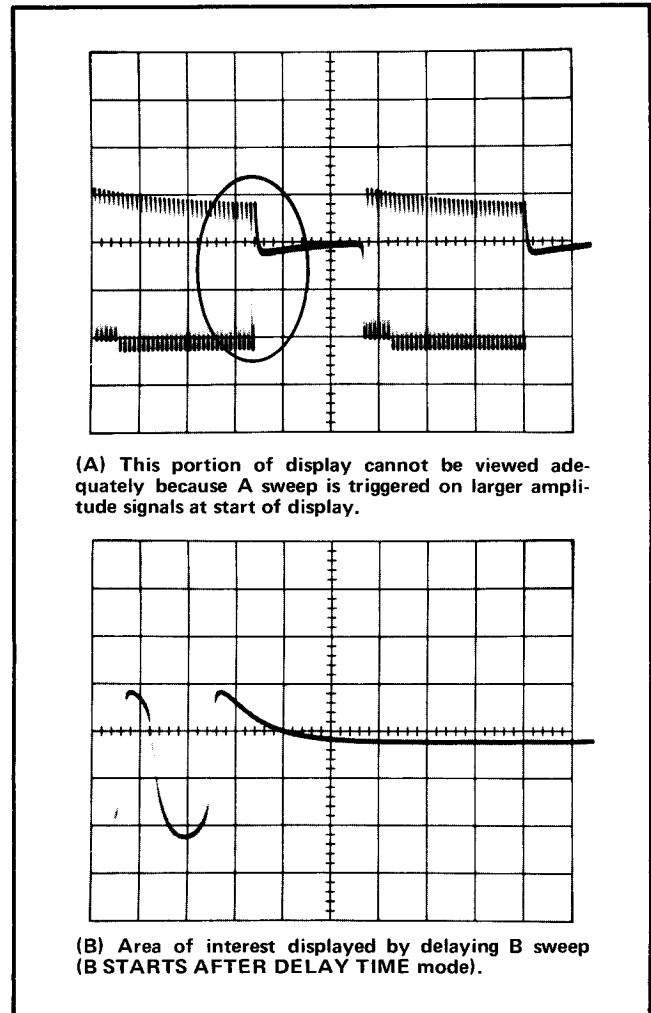


Fig. 2-24. Displaying a complex signal using delayed sweep.

Pulse Jitter Measurements

In some applications it is necessary to measure the amount of jitter on the leading edge of a pulse, or jitter between pulses.

Use the following procedure:

1. Connect the signal to either input connector. Set the MODE switch to display the channel used.
2. Set the VOLTS/DIV switch to display about four divisions of the waveform.
3. Set the A TIME/DIV switch to a sweep rate which displays the complete waveform.

Operating Instructions—453A/R453A

4. Set the A Triggering controls to obtain as stable a display as possible.

5. Set the HORIZ DISPLAY switch to A INTEN DURING B and the B SWEEP MODE switch to B STARTS AFTER DELAY TIME.

6. Position the start of the intensified portion with the DELAY-TIME MULTIPLIER dial so the pulse to be measured is intensified.

7. Set the B TIME/DIV switch to a setting which intensifies the full portion of the pulse that shows jitter.

8. Set the HORIZ DISPLAY switch to B (DELAYED SWEEP).

9. Pulse jitter is shown by horizontal movement of the pulse (take into account inherent jitter of Delayed Sweep). Measure the amount of horizontal movement. Be sure both variable controls are set to the calibrated position.

10. Multiply the distance measured in step 11 by the B TIME/DIV switch setting to obtain pulse jitter in time.

Example. Assume that the horizontal movement is 0.5 division (see Fig. 2-25), and the B TIME/DIV switch setting is .5 μ s.

Using the formula:

$$\text{Pulse Jitter} = \frac{\text{horizontal jitter}}{\text{(divisions)}} \times \text{B TIME/DIV setting}$$

Substituting the given value:

$$\text{Pulse Jitter} = 0.5 \times 0.5 \mu\text{s}$$

The pulse jitter is 0.25 microsecond.

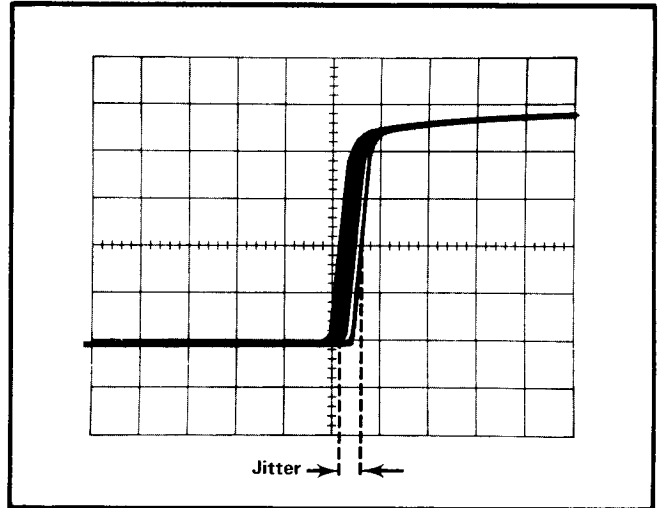


Fig. 2-25. Measuring pulse jitter.

Delayed Trigger Generator

The B GATE output signal can be used to trigger an external device at a selected delay time after the start of A Sweep. The delay time of the B GATE output signal can be selected by the setting of the DELAY-TIME MULTIPLIER dial and A TIME/DIV switch.

A Sweep Triggered Internally. When A sweep is triggered internally to produce a normal display, the delayed trigger may be obtained as follows.

1. Obtain a triggered display in the normal manner.
2. Set the HORIZ DISPLAY switch to A INTEN DURING B.
3. Select the amount of delay from the start of A Sweep with the DELAY-TIME MULTIPLIER dial. Delay time can be calculated in the normal manner.
4. Set the B SWEEP MODE switch to B STARTS AFTER DELAY TIME.
5. Connect the B GATE signal to the external equipment.
6. The duration of the B GATE signal is determined by the setting of the B TIME/DIV switch.
7. The external equipment will be triggered at the start of the intensified portion if it responds to positive-going

triggers, or at the end of the intensified portion if it responds to negative-going triggers.

A Sweep Triggered Externally. This mode of operation can be used to produce a delayed trigger with or without a corresponding display. Connect the external trigger signal to the A EXT TRIG INPUT connector and set the A SOURCE switch to EXT. Follow the operation given above to obtain the delayed trigger.

Normal Trigger Generator

Ordinarily, the signal to be displayed also provides the trigger signal for the oscilloscope. In some instances, it may be desirable to reverse this situation and have the oscilloscope trigger the signal source. This can be done by connecting the A GATE signal to the input of the signal source. Set the A LEVEL control fully clockwise, A SWEEP MODE switch to AUTO TRIG, and adjust the A TIME/DIV switch for the desired display. Since the signal source is triggered by a signal that has a fixed time relationship to the sweep, the output of the signal source can be displayed on the CRT as though the 453A were triggered in the normal manner (this method does not allow selection of trigger level or coupling).

Multi-Trace Phase Difference Measurements

Phase comparison between two signals of the same frequency can be made using the dual-trace feature of the 453A. This method of phase difference measurement can be used up to the frequency limit of the vertical system. To make the comparison, use the following procedure.

1. Set the Input Coupling switches to the same position, depending on the type of coupling desired.

2. Set the MODE switch to either CHOP or ALT. In general, CHOP is more suitable for low-frequency signals and the ALT position is more suitable for high-frequency signals. More information on determining the mode is given under Dual-Trace Operation in this section.

3. Set the INT TRIG switch to CH 1 OR X-Y.

4. Connect the reference signal to the CH 1 OR X connector and the comparison signal to the CH 2 OR Y connector. The reference signal should precede the comparison signal in time. Use coaxial cables or probes which have equal time delay to connect the signals to the input connectors.

5. If the signals are of opposite polarity, pull the INVERT switch out to invert the Channel 2 display. (Sig-

nals may be of opposite polarity due to 180° phase difference; if so, take this into account in the final calculation.)

6. Set the CH 1 and CH 2 VOLTS/DIV switches and the VAR VOLTS/DIV controls so the displays are equal and about five divisions in amplitude.

7. Set the triggering controls to obtain a stable display.

8. Set the TIME/DIV switch to a sweep rate which displays about one cycle of the waveform.

9. Move the waveforms to the center of the graticule with the vertical POSITION controls.

10. Turn the A VAR control until one cycle of the reference signal (Channel 1) occupies exactly eight divisions horizontally (see Fig. 2-26). Each division of the graticule represents 45° of the cycle ($360^\circ \div 8 \text{ divisions} = 45^\circ/\text{division}$). The sweep rate can be stated in terms of degrees as 45°/division.

11. Measure the horizontal difference between corresponding points on the waveforms.

12. Multiply the measured distance (in divisions) by 45°/division (sweep rate) to obtain the exact amount of phase difference.

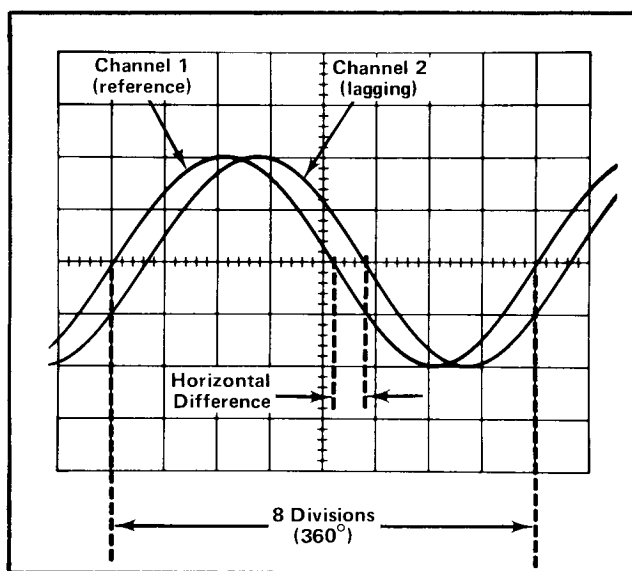


Fig. 2-26. Measuring phase difference.

Example. Assume a horizontal difference of 0.6 division with a sweep rate of $45^\circ/\text{division}$ as shown in Fig. 2-26.

Using the formula:

$$\text{Phase Difference} = \frac{\text{horizontal difference}}{\text{(divisions)}} \times \frac{\text{sweep rate}}{\text{(degrees/div)}}$$

Substituting the given values:

$$\text{Phase Difference} = 0.6 \times 45^\circ$$

The phase difference is 27° .

High Resolution Phase Measurements

More accurate dual-trace phase measurements can be made by increasing the sweep rate (without changing the A VAR control setting). One of the easiest ways to increase the sweep rate is with the MAG switch. Delayed sweep magnification may also be used. The magnified sweep rate is determined by dividing the sweep rate obtained previously by the amount of sweep magnification.

Example. If the sweep rate were increased 10 times with the magnifier, the magnified sweep rate would be $45^\circ/\text{division} \div 10 = 4.5^\circ/\text{division}$. Fig. 2-27 shows the same signals as used in Fig. 2-26 but with the MAG switch set to X10. With a horizontal difference of six divisions, the phase difference is:

$$\text{Phase Difference} = \frac{\text{horizontal difference}}{\text{(divisions)}} \times \frac{\text{magnified sweep rate}}{\text{(degrees/div)}}$$

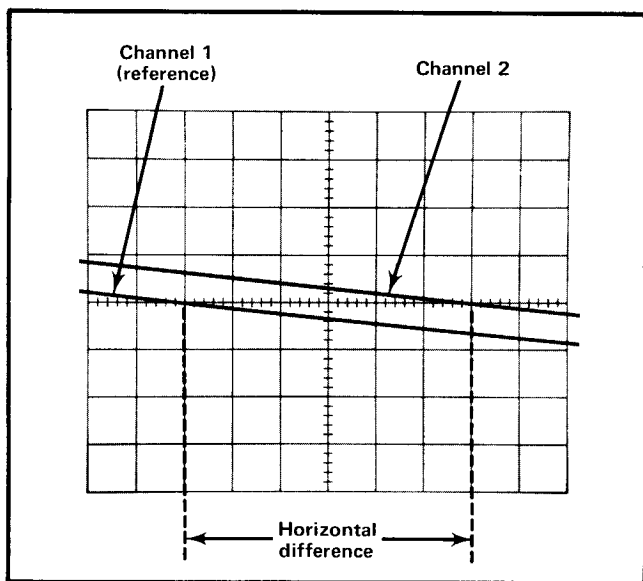


Fig. 2-27. High resolution phase-difference measurement with increased sweep rate.

Substituting the given values:

$$\text{Phase Difference} = 6 \times 4.5^\circ$$

The phase difference is 27° .

X-Y Phase Measurements

The X-Y phase measurement method can be used to measure the phase difference between two signals of the same frequency. This method provides an alternative method of measurement for signal frequencies up to about 100 kilohertz. However, above this frequency the inherent phase difference between the vertical and horizontal systems makes accurate phase measurements difficult. In this mode, one of the sine-wave signals provides horizontal deflection (X) while the other signal provides the vertical deflection (Y). The phase angle between the two signals can be determined from the lissajous pattern as follows:

1. Connect one of the sine-wave signals to both the CH 1 OR X and the CH 2 OR Y connectors. (Note: steps 1 through 5 measure inherent phase difference between the X and Y amplifiers to provide a more accurate X-Y phase measurement; not necessary below about 1 kHz).

2. Set the HORIZ DISPLAY switch to X-Y. Set the INT TRIG switch to CH 1 OR X-Y and the B SOURCE switch to INT.

3. Position the display to the center of the screen and adjust the VOLTS/DIV switches to produce a display less than six divisions vertically (Y) and less than 10 divisions horizontally (X). The CH 1 VOLTS/DIV switch controls the horizontal deflection (X) and the CH 2 VOLTS/DIV switch controls the vertical deflection (Y).

4. Center the display in relation to the vertical graticule line. Measure the distances A and B as shown in Fig. 2-28. Distance A is the horizontal measurement between the two points where the trace crosses the center horizontal line. Distance B is the maximum horizontal width of the display.

5. Divide A by B to obtain the sine of the phase angle (ϕ) between the two signals. The angle can then be obtained from a trigonometric table. This is the inherent phase shift of the instrument.

6. Connect the Y signal to CH 2 OR Y connector. Repeat steps 2 through 5 to measure phase angle. If the display appears as a diagonal straight line, the two signals are either in phase (tilted upper right to lower left) or 180° out of phase (tilted upper left to lower right). If the display

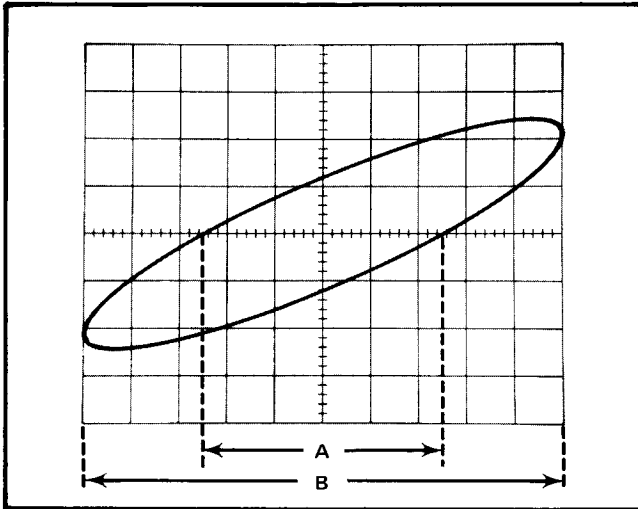


Fig. 2-28. Phase-difference measurement from an X-Y display.

7. Subtract the inherent phase shift from the phase angle ϕ to obtain the actual phase difference.

Example. Assume an inherent phase difference of 2° with a display as shown in Fig. 2-28 where A is 5 divisions and B is 10 divisions.

Using the formula:

$$\text{Sine } \phi = \frac{A}{B}$$

Substituting the given values:

$$\text{Sine } \phi = \frac{5}{10} = 0.5$$

From the trigonometric tables:

$$\phi = 30^\circ$$

is a circle, the signals are 90° out of phase. Fig. 2-29 shows the lissajous displays produced between 0° and 360° . Notice that above 180° phase shift, the resultant display is the same as at some lower angle.

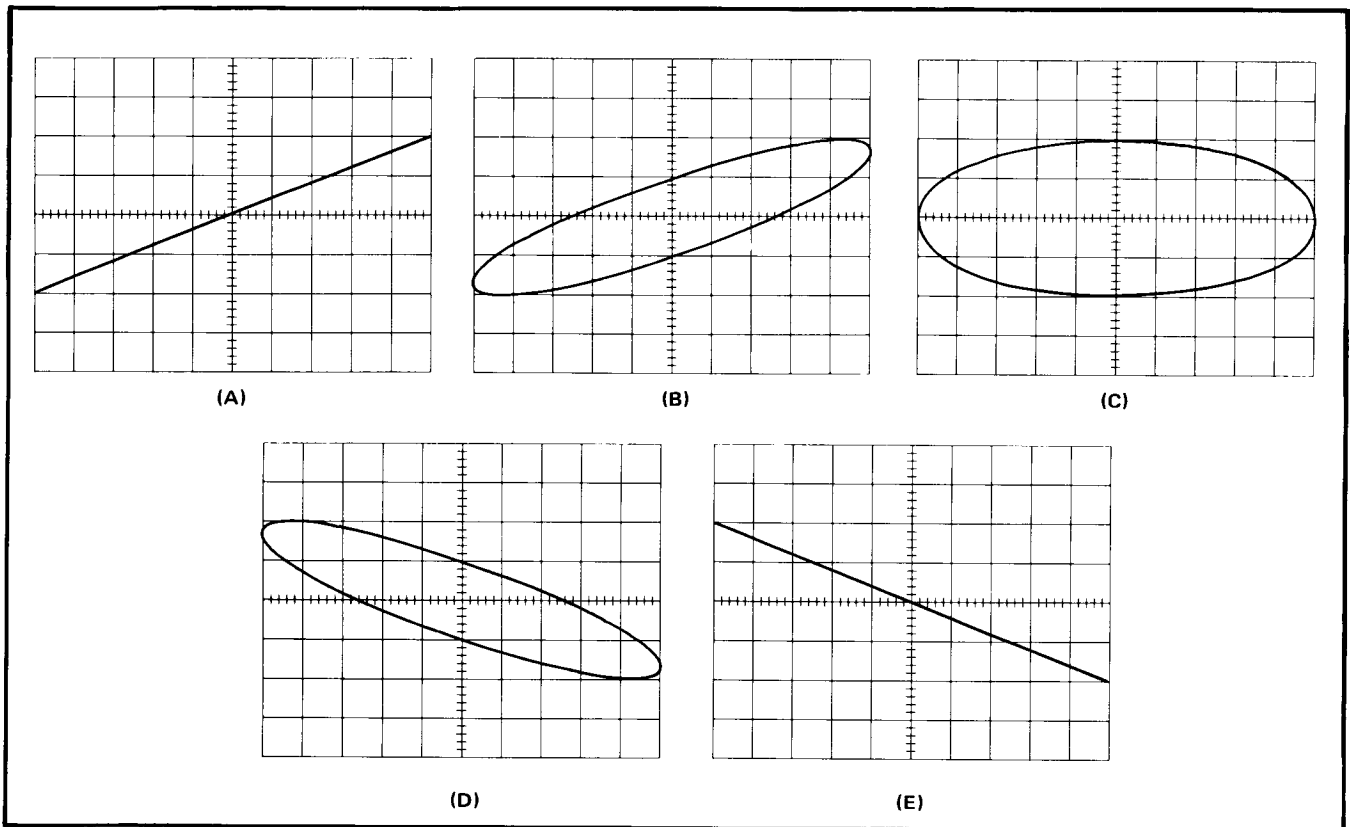


Fig. 2-29. Phase of lissajous display. (A) 0° or 360° , (B) 30° or 330° , (C) 90° or 270° , (D) 150° or 210° , (E) 180° .

Common-Mode Rejection

The ADD feature of the 453A can be used to display signals which contain undesirable components. These undesirable components can be eliminated through common-mode rejection. The precautions given under Algebraic Addition should be observed.

1. Connect the signal containing both the desired and undesired information to the CH 1 OR X connector.

2. Connect a signal similar to the unwanted portion of the Channel 1 signal to the CH 2 OR Y connector. For example, in Fig. 2-30 a line-frequency signal is connected to Channel 2 to cancel out the line-frequency component of the Channel 1 signal.

3. Set both Input Coupling switches to DC (AC if DC component of input signal is too large).

4. Set the MODE switch to ALT. Set the VOLTS/DIV switches so the signals are about equal in amplitude.

5. Set the INT TRIG switch to NORM.

6. Set the MODE switch to ADD. Pull the INVERT switch so the common-mode signals are of opposite polarity.

7. Adjust the CH 2 VOLTS/DIV switch and CH 2 VAR control for maximum cancellation of the common-mode signal.

8. The signal which remains should be only the desired portion of the Channel 1 signal. The undesired signal is cancelled out.

Example. An example of this mode of operation is shown in Fig. 2-30. The signal applied to Channel 1 contains unwanted line-frequency components (Fig. 2-30A). A corresponding line-frequency signal is connected to Channel 2 (Fig. 2-30B). Fig. 2-30C shows the desired portion of the signal as displayed when common-mode rejection is used.

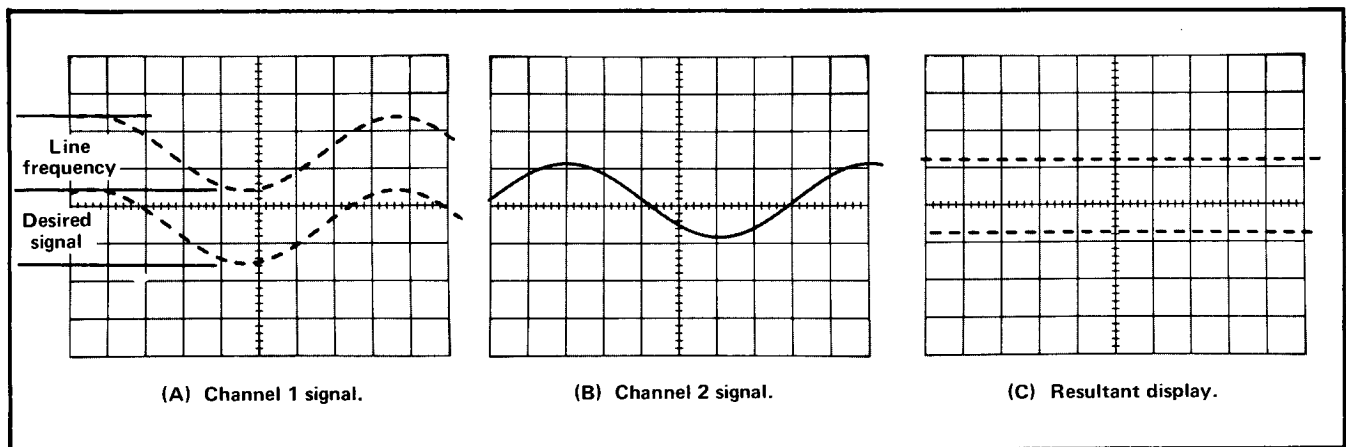


Fig. 2-30. Using the ADD feature for common-mode rejection. (A) Channel 1 signal contains desired information along with line-frequency component, (B) Channel 2 signal contains line-frequency only, (C) CRT display using common-mode rejection.

SECTION 3

CIRCUIT DESCRIPTION

Change information, if any, affecting this section will be found at the rear of this manual.

Introduction

This section of the manual contains a description of the circuitry used in the 453A Oscilloscope. The description begins with a discussion of the instrument using the basic block diagram shown in Fig. 3-1. Then, each circuit is described in detail, using a detailed block diagram to show the interconnections between the stages in each major circuit and the relationship of the front-panel controls to the individual stages.

A complete block diagram is located in the Diagrams section at the rear of this manual. This block diagram shows the overall relationship between all of the circuits. Complete schematics of each circuit are also given in the Diagrams section. Refer to these diagrams throughout the following circuit description for electrical values and relationship.

BLOCK DIAGRAM

General

The following discussion is provided to aid in understanding the overall concept of the 453A before the individual circuits are discussed in detail. A basic block diagram of the 453A is shown in Fig. 3-1. Only the basic interconnections between the individual blocks are shown on this diagram. Each block represents a major circuit within this instrument. The number on each block refers to the complete circuit diagram which is located at the rear of this manual.

Signals to be displayed on the CRT are applied to either the CH 1 OR X and/or the CH 2 OR Y connectors. The input signals are then amplified by the Channel 1 Vertical Preamp and/or the Channel 2 Vertical Preamp circuits. Each Vertical Preamp circuit includes separate vertical deflection factor, position, input coupling, gain, variable attenuation, and balance controls. A trigger-pickoff stage in the Channel 1 Vertical Preamp circuit supplies a sample of the Channel 1 signal to the Trigger Preamp circuit or the CH 1 OUT connector. The Channel 2 Vertical Preamp circuit contains an invert feature to invert the Channel 2 signal as displayed on the CRT. The output of both Vertical Preamp circuits is connected to the Vertical Switching circuit. This circuit selects the channel(s) to be displayed. An output signal from this circuit is connected to the Z

Axis Amplifier circuit to blank out the between-channel switching transients when in the chopped mode of operation. A trigger-pickoff stage at the output of the Vertical Switching circuit provides a sample of the displayed signal(s) to the Trigger Preamp circuit.

The output of the Vertical Switching circuit is connected to the Vertical Output Amplifier through the Delay Line. The Vertical Output Amplifier circuit provides the final amplification for the signal before it is connected to the vertical deflection plates of the CRT. This circuit includes the BEAM FINDER switch which compresses the vertical and horizontal deflection within the viewing area to aid in locating an off-screen display.

The Trigger Preamp circuit provides amplification for the internal trigger signal selected by the INT TRIG switch. This internal trigger signal is selected from either the Channel 1 Vertical Preamp circuit or the Vertical Switching circuit. Output from this circuit is connected to the A Trigger Generator circuit and the B Trigger Generator circuit.

The A and B Trigger Generator circuits produce an output pulse which initiates the sweep signal produced by the A or B Sweep Generator circuits. The input signal to the A and B Trigger Generator circuits can be individually selected from the internal trigger signal from the Trigger Preamp circuit, an external signal applied to the EXT TRIG INPUT connector, or a sample of the line voltage applied to the instrument. Each trigger circuit contains level, slope, coupling, and source controls.

The A Sweep Generator circuit produces a linear sawtooth output signal when initiated by the A Trigger Generator circuit. The slope of the sawtooth produced by the A Sweep Generator circuit is controlled by the A TIME/DIV switch. The operating mode of the A Sweep Generator circuit is controlled by the A SWEEP MODE switch. In the AUTO TRIG position, the absence of an adequate trigger signal causes the sweep to free run. In the NORM TRIG position, a horizontal sweep is presented only when correctly triggered by an adequate trigger signal. The SINGLE SWEEP position allows one (and only one) sweep to be initiated after the circuit is reset with the RESET button. The A Sweep Generator circuit also produces an unblanking gate signal to unblank the CRT so the display can be pre-

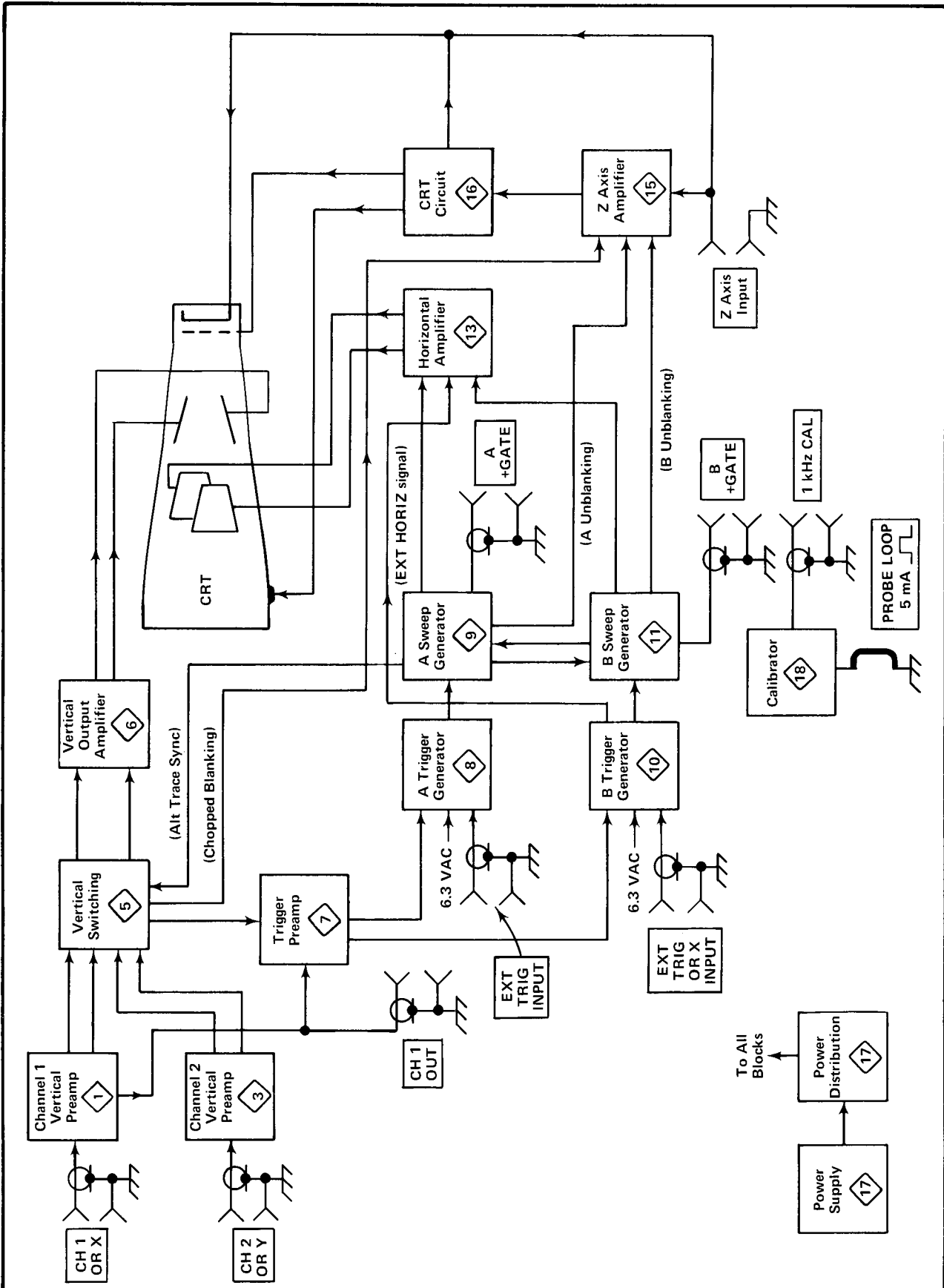


Fig. 3-1. Basic block diagram of 453A.

sented. This gate signal is coincident with the sawtooth produced by the A Sweep Generator circuit. A gate signal, which is also coincident with the sawtooth, is available at the A GATE connector on the side panel. The A Sweep Generator circuit also produces an alternate sync pulse, which is connected to the Vertical Switching circuit. This pulse switches the display between channels at the end of each sweep when the MODE switch is in the ALT position.

The B Sweep Generator circuit is basically the same as the A Sweep Generator circuit. However, this circuit only produces a sawtooth output signal after a delay time determined by the A TIME/DIV switch and the DELAY-TIME MULTIPLIER dial. If the B SWEEP MODE switch is set to the B STARTS AFTER DELAY TIME position, the B Sweep Generator begins to produce the sweep immediately following the selected delay time. If this switch is in the TRIGGERABLE AFTER DELAY TIME position, the B Sweep Generator circuit does not produce a sweep until it receives a trigger pulse from the B Trigger Generator circuit after the selected delay time.

The output of either the A or B Sweep Generator circuit is amplified by the Horizontal Amplifier circuit to produce horizontal deflection for the CRT in all positions of the HORIZ DISPLAY switch except X-Y. This circuit contains a 10 times magnifier to increase the sweep rate ten times in any A or B TIME/DIV switch position. Other horizontal deflection signals can be connected to the Horizontal Amplifier by using the X-Y mode of operation. When the B SOURCE switch is set to INT, the X signal is connected to the Horizontal Amplifier circuit through the CH 1 Vertical Preamp circuit, the Trigger Preamp circuit and the B Trigger Generator circuit (HORIZ DISPLAY switch set to X-Y, B SOURCE switch set to INT, and the INT TRIG switch set to CH 1 OR X-Y). In the EXT or $EXT \div 10$ position of the B SOURCE switch, the X signal is obtained from a signal connected to the B EXT TRIG OR X INPUT connector.

The Z Axis Amplifier circuit determines the CRT intensity and blanking. The Z Axis Amplifier circuit sums the current inputs from the INTENSITY control, Vertical Switching circuit (chopped blanking), A and B Sweep Generator circuits (unblanking), and the external Z AXIS INPUT binding post. The output level of the Z Axis Amplifier circuit controls the trace intensity through the CRT Circuit. The CRT Circuit provides the voltages and contains the controls necessary for operation of the cathode-ray tube.

The Power Supply circuit provides the low-voltage power necessary for operation of this instrument. This voltage is distributed to all of the circuits in this instrument as shown by the Power Distribution diagram. The Calibrator circuit produces a square-wave output with accurate amplitude and frequency which can be used to check the

calibration of the instrument and the compensation of probes. The PROBE LOOP provides an accurate current source for calibration of current-measuring probe systems.

CIRCUIT OPERATION

General

This section provides a detailed description of the electrical operation and relationship of the circuits in the 453A. The theory of operation for circuits unique to this instrument is described in detail in this discussion. Circuits which are commonly used in the electronics industry are not described in detail. If more information is desired on these commonly used circuits, refer to the following textbooks:

Tektronix Circuit Concepts Books (order from your local Tektronix Field Office or representative).

Cathode-Ray Tubes, Tektronix Part No. 062-0852-01.

Horizontal Amplifier Circuits, Tektronix Part No. 062-1144-00.

Oscilloscope Trigger Circuits, Tektronix Part No. 062-1056-00.

Power Supply Circuits, Tektronix Part No. 062-0888-01.

Sweep Generator Circuits, Tektronix Part No. 062-1098-01.

Vertical Amplifier Circuits, Tektronix Part No. 062-1145-00.

Phillip Cutler, "Semiconductor Circuit Analysis", McGraw-Hill, New York, 1964.

Lloyd P. Hunter (Ed.), "Handbook of Semiconductor Electronics", second edition, McGraw-Hill, New York, 1962.

Jacob Millman and Herbert Taub, "Pulse, Digital, and Switching Waveforms", McGraw-Hill, New York, 1965.

The following circuit analysis is written around the detailed block diagrams which are given for each major circuit. These detailed block diagrams give the names of the individual stages within the major circuits and show how they are connected together to form the major circuit. The block diagrams also show the inputs and outputs for each circuit and the relationship of the front-panel controls to the individual stages. The circuit diagrams from which the detailed block diagrams are derived are shown in the Diagrams section.

NOTE

All references to direction of current in this manual are in terms of conventional current; i.e., from plus to minus.

CHANNEL 1 VERTICAL PREAMP

General

Input signals for vertical deflection on the CRT can be connected to the CH 1 OR X connector. In the X-Y mode of operation, this input signal provides the horizontal (X-axis) deflection (HORIZ DISPLAY switch set to X-Y, B SOURCE switch set to INT, and INT TRIG switch set to CH 1 OR X). The Channel 1 Vertical Preamp circuit provides control of input coupling, vertical deflection factor, balance, vertical position, and vertical gain. It also contains a stage to provide a sample of the Channel 1 input signal to the Trigger Preamp circuit to provide internal triggering from the Channel 1 signal only. Fig. 3-2 shows a detailed block diagram of the Channel 1 Vertical Preamp circuit. A schematic of this circuit is shown on diagram 1 at the rear of this manual.

Input Coupling

Input signals applied to the CH 1 OR X connector can be AC-coupled, DC-coupled, or internally disconnected. When Input Coupling switch S1 is in the DC position, the input signal is coupled directly to the Input Attenuator stage. In the AC position, the input signal passes through capacitor C1. This capacitor prevents the DC component of the signal

from passing to the amplifier. The GND position opens the signal path and the input to the amplifier is connected to ground. This provides a ground reference without the need to disconnect the applied signal from the CH 1 connector. Resistor R2, connected across the input coupling switch, allows C1 to be precharged in the GND position so the trace remains on screen when switched to the AC position with a high DC level applied.

Input Attenuator

The effective overall Channel 1 deflection factor of the 453A is determined by the CH 1 VOLTS/DIV switch. In all positions of the CH 1 VOLTS/DIV switch above 20 mV, the basic deflection factor of the Vertical Deflection System is 20 millivolts per division of CRT deflection. To increase this basic deflection factor to the values indicated on the front panel, precision attenuators are switched into the circuit. In the 5 and 10 mV positions, input attenuation is not used. Instead, the gain of the Feedback Amplifier is changed to decrease the deflection factor (see Feedback Amplifier discussion).

For the CH 1 VOLTS/DIV switch positions above 20 mV, the attenuators are switched into the circuit singly or in pairs to produce the vertical deflection factor indicated on the front panel. These attenuators are frequency-compensated voltage dividers. For DC and low-frequency signals, they are primarily resistance dividers and the voltage attenuation is determined by the resistance ratio in the circuit. The reactance of the capacitors in the circuit is so high at low frequencies that their effect is negligible. How-

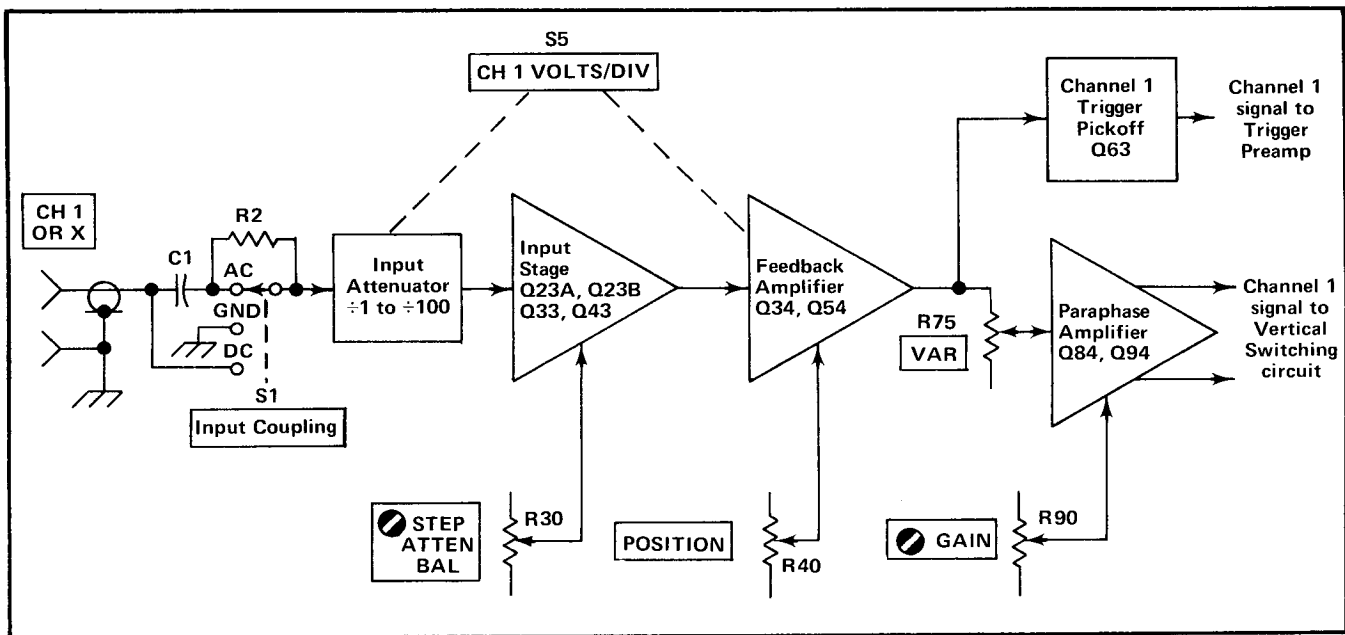


Fig. 3-2. Channel 1 Vertical Preamp detailed block diagram.

ever, at higher frequencies, the reactance of the capacitors decreases and the attenuator becomes primarily a capacitance voltage divider.

In addition to providing constant attenuation at all frequencies within the bandwidth of the instrument, the Input Attenuators are designed to maintain the same input RC characteristics (one megohm X 20 pF) for each setting of the CH 1 VOLTS/DIV switch. Each attenuator contains an adjustable series capacitor to provide correct attenuation at high-frequencies and an adjustable shunt capacitor to provide correct input capacitance.

Input Stage

The Channel 1 signal from the Input Attenuator is connected to the Input Stage through the network C17-C18-C20-R16-R17-R18-R19-R20-R21. R16, R17, and R20 provide the input resistance for this stage. These resistors are part of the attenuation network at all CH 1 VOLTS/DIV switch positions. Variable capacitor C17 adjusts the basic input time constant for a nominal value of one megohm X 20 picofarads. The divider action of R16-R17-R20 allows about 98% of DC and low-frequency signals to pass to the gate of FET (field-effect transistor) Q23A. C18, with the stray capacitance in the circuit, forms an AC divider which maintains this same voltage division for high-frequency signals. R18 limits the current drive to the gate of Q23A. Diode CR18 protects the circuit by clamping the gate of Q23A at about -12.5 volts if a high-amplitude negative signal is applied to the CH 1 OR X connector. Over-voltage protection for high-amplitude positive signals is provided by forward conduction of Q23A. This current path is through R23, L23, CR36, and CR37.

FET Q23B is a constant current source for Q23A and also provides temperature compensation for Q23A. STEP ATTEN BAL adjustment R30 varies the gate level of Q23B to provide a zero-volt level at the emitter of Q34 with no signal applied. With a zero-volt level at the emitter of Q34, the trace position will not change when switching between the 5, 10, and 20 mV positions of the CH 1 VOLTS/DIV switch.

DC and low-frequency signals are connected from the source of Q23A to the Feedback Amplifier through R23, L23, Q33, and R39. L23 isolates the base of Q33 from the source of FET Q23A. Diodes CR34-CR35 and CR36-CR37 limit the dynamic range of the signal at the base of Q33 and prevent the following stages from being damaged by a large voltage swing at the source of Q23A. The signal path for high-frequency signals is through C23, Q43, and C39. High-frequency signals at the emitter of Q43 are connected to the base of Q33 through C38. This allows Q33 to be driven at high frequencies while preventing the base circuitry of Q33 from capacitively loading the input FET, Q23A. C38 is

selected to provide the same amplitude AC and DC signal at the base of Q33. C24 couples high-frequency information to the junction of R25-R26, thereby reducing the loading at the base of Q43.

Feedback Amplifier

Feedback Amplifier Q34 and Q54 changes the overall gain of the Channel 1 Vertical Preamp to provide the correct deflection factor in the 5 and 10 mV positions of the CH 1 VOLTS/DIV switch. Gain of this stage is determined by the ratio of R46-R50 to R43, R44, or R45. In the 5 mV position of the CH 1 VOLTS/DIV switch, the network C43A-C43B-C43C-C43D-C43E-L43A-R43A-R43C-R43E is connected into the emitter circuit of Q34. The ratio between R46-R50 and R43 provides a gain of about 10. C43A, C43C, L43A, and R43C are adjustable to provide high-frequency peaking for the network. In the 10 mV position, conditions are the same except that the network C44A-C44B-C44C-L44A-R44A-R44B-R44C is connected into the circuit in place of the previous network. The ratio between R46-R50 and R44 provides a gain of about five times in this CH 1 VOLTS/DIV switch position. C44C and R44C provide high frequency peaking for this network. In the 20 mV and higher CH 1 VOLTS/DIV switch positions, the gain of the Feedback Amplifier is about 2.5 as established by the ratio between R46-R50 and R45. Adjustable capacitor C45A provides high-frequency peaking for the Feedback Amplifier stage. C49 and R49 provide high-frequency damping for the circuit. As mentioned previously, the STEP ATTEN BAL adjustment is set to provide zero volts at the emitter of Q34 when the input is at zero volts. Since there is no voltage difference across emitter resistor R43, R44, or R45, changing the value of the resistance does not change the current in the circuit. Therefore, the trace position will not change when switching between the 5 mV, 10 mV, and 20 mV positions of the CH 1 VOLTS/DIV switch if the STEP ATTEN BAL control is correctly adjusted.

Vertical position of the trace is determined by the setting of POSITION control R40. This control changes the current into the emitter of Q34, a low-impedance point, which results in negligible voltage change at this point. However, the change in current from the POSITION control produces a resultant DC voltage at the output of the Feedback Amplifier stage to change the vertical position of the trace. CH 1 Position Center adjustment R55 is adjusted to provide a centered display when the Channel 1 POSITION control is centered (with a zero-volt DC input level).

Zener diode VR53 provides a low-impedance current source for Q54. Variable capacitor C54 provides feedback from the collector to the base of Q54 for amplifier stabilization. The output signal from the Feedback Amplifier stage is connected to the Paraphase Amplifier stage and the Channel 1 Trigger Pickoff stage.

Channel 1 Trigger Pickoff

The signal at the collector of Q54 in the Feedback Amplifier stage is connected to the Channel 1 Trigger Pickoff stage through CR58 and R59. This sample of the Channel 1 input signal provides internal triggering from the Channel 1 signal or X-axis deflection for X-Y operation. Q63 is connected as an emitter follower to provide isolation between the Trigger Preamp circuit and the Feedback Amplifier stage. It also provides a minimum load for the Feedback Amplifier stage and a low output impedance to the Trigger Preamp circuit. CR58 provides thermal compensation for Q63. CH 1 Trigger DC Level adjustment R60 sets the DC level at the base of Q63 for a zero-volt DC output level from the Trigger Preamp circuit when the Channel 1 trace is centered vertically. Output from the Channel 1 Trigger Pickoff stage is connected to the Trigger Preamp circuit through INT TRIG switch S230B.

Paraphase Amplifier

The output signal from the Feedback Amplifier stage is connected to the Paraphase Amplifier stage through VAR (variable) control R75. When the VAR control is set to the calibrated position (fully clockwise), R75 is effectively by-passed and maximum signal current reaches the base of Q84. Switch S75, ganged with the VAR control, is open and the UNCAL neon bulb is disconnected. As the VAR control is rotated counterclockwise from the calibrated detent, S75 is closed and UNCAL light DS75 ignites to indicate that the vertical deflection factor is uncalibrated. The signal applied to the base of Q84 is continuously reduced as the VAR control is rotated counterclockwise.

Q84 and Q94 are connected as a common-emitter phase inverter (paraphase amplifier) to convert the single-ended input signal to a push-pull output signal. Gain of this stage is determined by the emitter degeneration. As the resistance between the emitters of Q84 and Q94 increases, emitter degeneration increases also to result in less gain through the stage. GAIN adjustment R90 varies the resistance between the emitters to control the overall gain of the Channel 1 Vertical Preamp.

CHANNEL 2 VERTICAL PREAMP

General

The Channel 2 Vertical Preamp circuit is basically the same as the Channel 1 Vertical Preamp circuit. Only the differences between the two circuits are described here. Portions of this circuit not described in the following description operate in the same manner as for the Channel 1 Vertical Preamp circuit (corresponding circuit numbers assigned in the 100-199 range). Fig. 3-3 shows a detailed block diagram of the Channel 2 Vertical Preamp circuit. A schematic of this circuit is shown on diagram 3 at the rear of this manual.

Feedback Amplifier

Basically, the Channel 2 Feedback Amplifier operates as described for Channel 1. However, the Channel 2 Vertical Preamp circuit does not have a trigger pickoff stage. To provide a load at the collector of Q154 similar to the load the Channel 1 Trigger Pickoff stage provides at the collector of Q54, C159 and R159 are connected into the circuit.

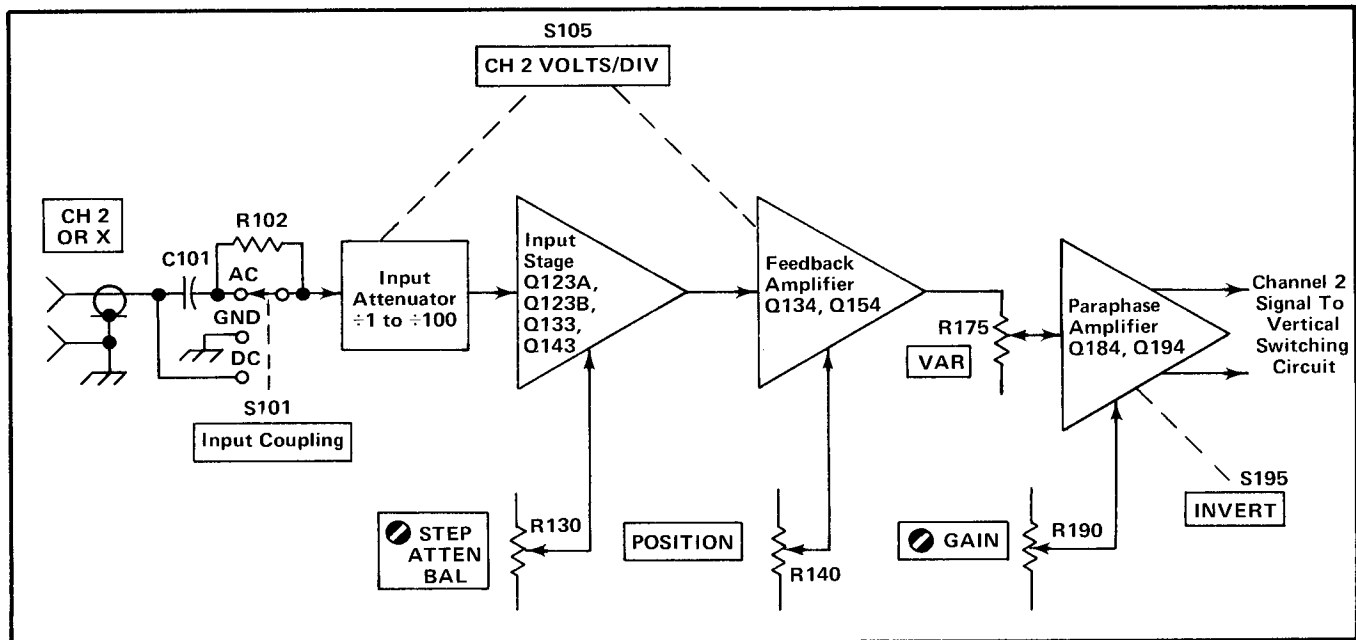


Fig. 3-3. Channel 2 Vertical Preamp detailed block diagram.

Paraphase Amplifier

The basic Channel 2 Paraphase Amplifier configuration and operation is the same as for Channel 1. However, INVERT switch S195 has been added in the Channel 2 circuit. This switch allows the displayed signal from Channel 2 to be inverted.

VERTICAL SWITCHING

General

The Vertical Switching circuit determines if the CH 1 and/or the CH 2 Vertical Preamp output signal is connected to the Vertical Output Amplifier circuit (through the Delay Line Driver and Delay Line stages). In the ALT and CHOP positions of the MODE switch, both channels are alternately displayed on a shared-time basis. Fig. 3-4 shows a detailed block diagram of the Vertical Switching circuit. A schematic of this circuit is shown on diagram 5 at the rear of this manual.

Diode Gates

The Diode Gates, consisting of four diodes each, can be thought of as switches which allow either of the Vertical

Preamp output signals to be coupled to the Vertical Output Amplifier. CR201 through CR204 control the Channel 1 output and CR206 through CR209 control the Channel 2 output. These diodes are in turn controlled by the Switching Multivibrator for dual-trace displays, or by the MODE switch for single-trace displays.

CH 1. In the CH 1 position of the MODE switch, -12 volts is applied to the junction of CR207-CR208 in the Channel 2 Diode Gate through R227 (see simplified diagram in Fig. 3-5). This forward biases CR207-CR208 and reverse biases CR206-CR209, since the input to the Delay-Line Driver stage is at about -5.8 volts. CR206-CR209 block the Channel 2 signal so it cannot pass to the Delay-Line Driver stage. At the same time, in the Channel 1 Diode Gate, CR202-CR203 are connected to ground through R212. CR202-CR203 are held reverse biased while CR201-CR204 are forward biased. Therefore, the Channel 1 signal passes to the Delay-Line Driver stage.

CH 2. In the CH 2 position of the MODE switch, the above conditions are reversed. CR202-CR203 are connected to -12 volts through R217 and CR207-CR208 are connected to ground through R222. The Channel 1 Diode Gate blocks the signal and the Channel 2 Diode Gate allows it to pass.

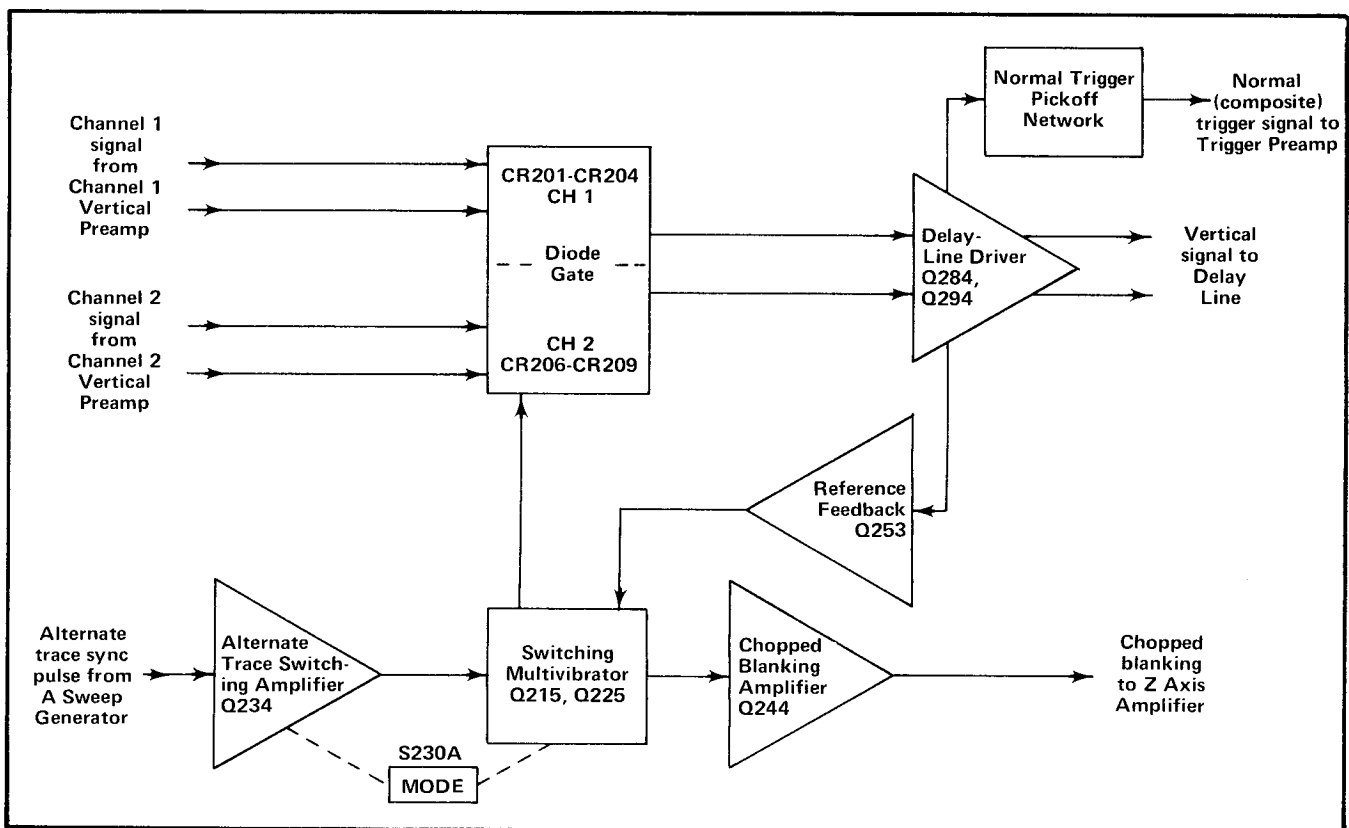


Fig. 3-4. Vertical Switching detailed block diagram.

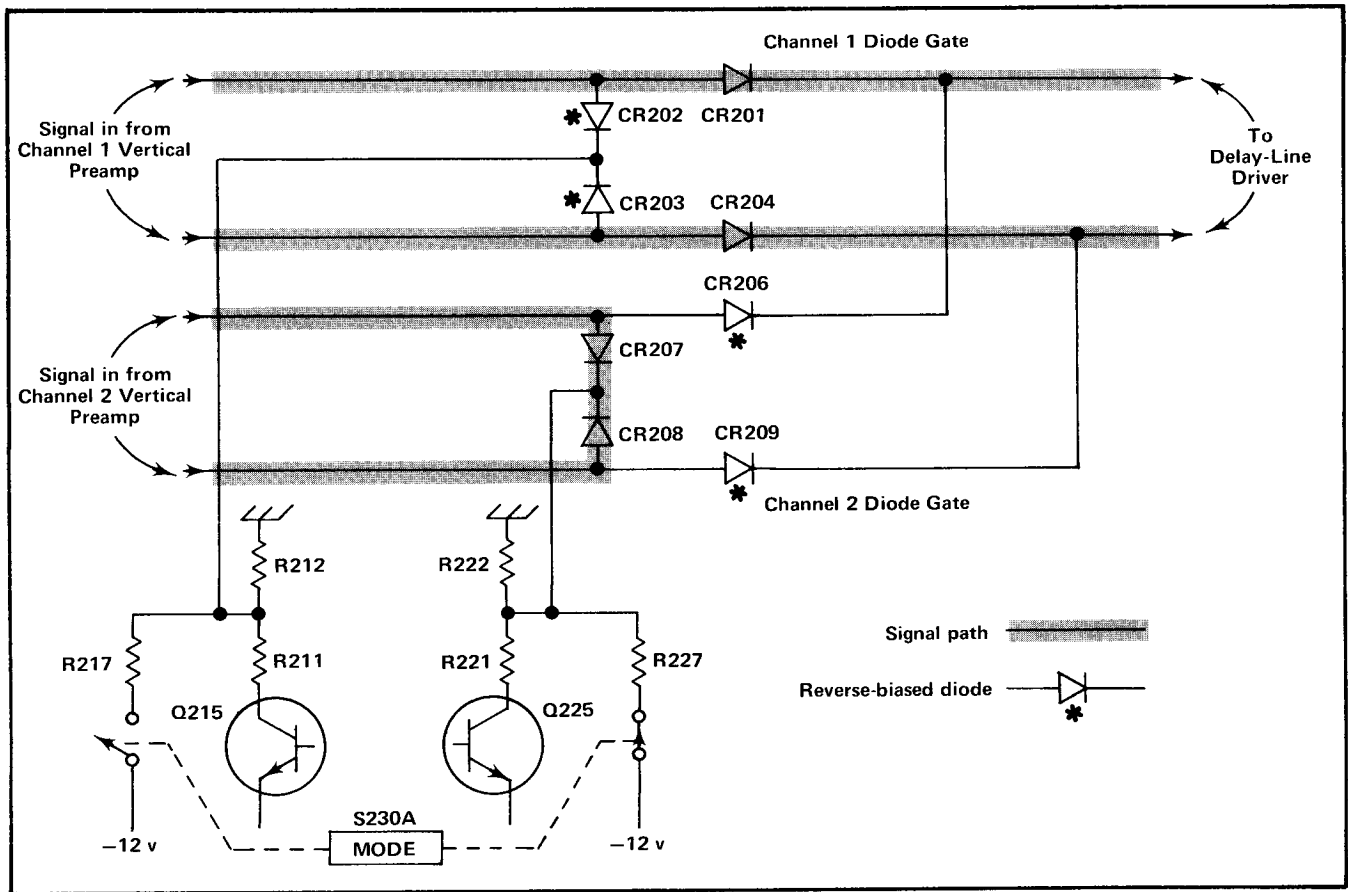


Fig. 3-5. Effect of Diode Gates on signal path (simplified Vertical Switching diagram). Conditions shown for CH 1 position of MODE switch.

Switching Multivibrator

ALT. In this mode of operation, the Switching Multivibrator operates as a bistable multivibrator. In the ALT position of the MODE switch, -12 volts is applied to the emitter of Alternate Trace Switching Amplifier stage Q234 by the MODE switch. Q234 is forward biased to supply current to the "on" Switching-Multivibrator transistor through R234, and CR218 or CR228. For example if Q225 is conducting, current is supplied to Q225 through R228. The current flow through collector resistors R221 and R222 drops the CR207-CR208 cathode level negative so the Channel 2 Diode Gate is blocked as for Channel 1 only operation. The signal passes through the Channel 1 Diode Gate to the Delay-Line Driver stage.

The alternate-trace sync pulse is applied to Q234 at the end of each sweep. This negative-going sync pulse momentarily interrupts the current through Q234 and both Q215 and Q225 are turned off. When Q234 turns on again after the alternate-trace sync pulse, the charge on C218 determines whether Q215 or Q225 conducts. For example, when Q225 was conducting, C218 was charged negatively on the CR218 side to the emitter level of Q215 and positively on the CR228 side. This charge is stored while

Q234 is off and holds the emitter of Q215 more negative than the emitter of Q225. When both Q215 and Q225 were off the voltage at their bases became approximately equal. Now when Q234 comes back on, the transistor with the most negative emitter will start conducting first with the resulting negative movement at its collector holding the other transistor off. The conditions described previously are reversed; now the Channel 1 Diode Gate is reverse biased and the Channel 2 signal passes through the Channel 2 Diode Gate.

Reference Feedback stage Q253 provides common-mode voltage feedback from the Delay-Line Driver stage to allow the diode gates to be switched with a minimum amplitude switching signal. The emitter level of Q253 is connected to the junction of the Switching Multivibrator collector resistors, R211-R212 and R221-R222 through CR213 or CR223. The collector level of the "on" Switching Multivibrator transistor is negative and either CR213 or CR223 is forward biased. This clamps the cathode level of the forward-biased shunt diodes in the applicable Diode Gate about 0.5 volt more negative than the emitter level of Q253. The level at the emitter of Q253 follows the average voltage level at the emitters of the Delay-Line Driver stage. The shunt diodes are clamped near their switching level and

therefore they can be switched very fast with a minimum amplitude switching signal. This maintains about the same current through the Diode Gate shunt diodes so they can be switched with a minimum amplitude switching signal, regardless of the deflection signal at the anodes of the shunt diodes.

CHOP. In the CHOP position of the MODE switch, the Switching Multivibrator free runs as an astable multivibrator at about a 500-kHz rate. The emitters of Q215 and Q225 are connected to -12 volts through R218 and R228. At the time of turn-on, one of the transistors begins to conduct; for example, Q225. Q225 conducts the Channel 2 current and prevents the Channel 2 signal from reaching the Delay-Line Driver stage. Meanwhile, the Channel 1 Diode Gate passes the Channel 1 signal to the Delay-Line Driver.

The frequency-determining components in the CHOP mode are C218-R218-R228. Switching action occurs as follows: When Q225 is on, C218 attempts to charge to -12 volts through R218. The emitter of Q215 slowly goes toward -12 volts as C218 charges. The base of Q215 is held at a negative point determined by voltage divider R215-R224 between -12 volts and the collector of Q225. When the emitter voltage of Q215 reaches a level slightly more negative than its base, Q215 conducts. The collector level of Q215 goes negative and pulls the base of Q225 negative also, through divider R214-R225, to cut Q225 off and allow Q215 to conduct. This action switches the Diode Gate stage to connect the opposite half to the Delay-Line Driver stage. Again C218 begins to charge towards -12 volts but this time through R228. The emitter of Q225 slowly goes negative as C218 charges, until Q225 turns on. Q215 shuts off and the cycle begins again.

Diodes CR218 and CR228 have no effect in the CHOP mode. Q253 operates the same in CHOP as in ALT, to allow the Diode Gates to be switched with a minimum signal level.

The Chopped Blanking Amplifier stage, Q244, provides an output pulse to the Z Axis Amplifier which blanks out the transition between the Channel 1 trace and the Channel 2 trace. When the Switching Multivibrator changes states, the current through T241 momentarily changes. A negative pulse is applied to the base of Q244, to turn it off. The width of the pulse at the base of Q244 is determined by R241 and C241. Q244 clips the signal applied to its base, and the positive-going output pulse, which is coincident with trace switching, is applied to the Z Axis Amplifier circuit through R245.

ADD. In the ADD position of the MODE switch, the Diode Gate stage allows both signals to pass to the Delay-Line Driver stage. The Diode Gates are both held on by

-12 volts applied to their cathodes through R260 and R270. Since both signals are applied to the Delay-Line Driver stage, the output signal is the algebraic sum of the signals on both Channel 1 and 2.

Delay-Line Driver

Output of the Diode Gate stage is applied to Delay-Line Driver stage Q284 and Q294. Q284 and Q294 are connected as operational amplifiers with feedback provided by R268-R269 and R278-R279 and the delay-line compensation network. The delay-line compensation network, C261-C262-C263-C264-C265-C266-R261-R262-R264-R265, provides high-frequency compensation for the Delay Line. R289-C289 in the collector circuit of Q284-Q294 improve the high-frequency reverse termination of the Delay Line. Output of the Delay-Line Driver stage is connected to the Vertical Output Amplifier through the Delay Line.

Normal Trigger Pickoff Network

The trigger signal for NORM trigger operation is obtained from the collector of Q284. Normal Trigger DC Level adjustment R285 sets the DC level of the normal trigger output signal so the sweep is triggered at the zero-level of the displayed signal when the Triggering LEVEL control is set to 0. The normal trigger signal is connected to the Trigger Preamp through S230B. R294 and R295 provide the same DC load for Q294 as provided to Q284 by the Normal Trigger Pickoff Network.

VERTICAL OUTPUT AMPLIFIER

General

The Vertical Output Amplifier circuit provides the final amplification for the vertical deflection signal. This circuit includes the Delay Line and the BEAM FINDER switch. The BEAM FINDER switch compresses an overscanned display within the viewing area when pressed in. Fig. 3-6 shows a detailed block diagram of the Vertical Output Amplifier circuit. A schematic of this circuit is shown on diagram 6 at the rear of this manual.

Delay Line

Delay Line DL301 provides approximately 140 nanoseconds delay for the vertical signal to allow the Sweep Generator circuits time to initiate a sweep before the vertical signal reaches the vertical deflection plates. This allows the instrument to display the leading edge of the signal originating the trigger pulse when using internal triggering.

Phase Equalizer Network

The Phase Equalizer Network is comprised of L301-L302-L311-C301-C302-C311-C312. This network compen-

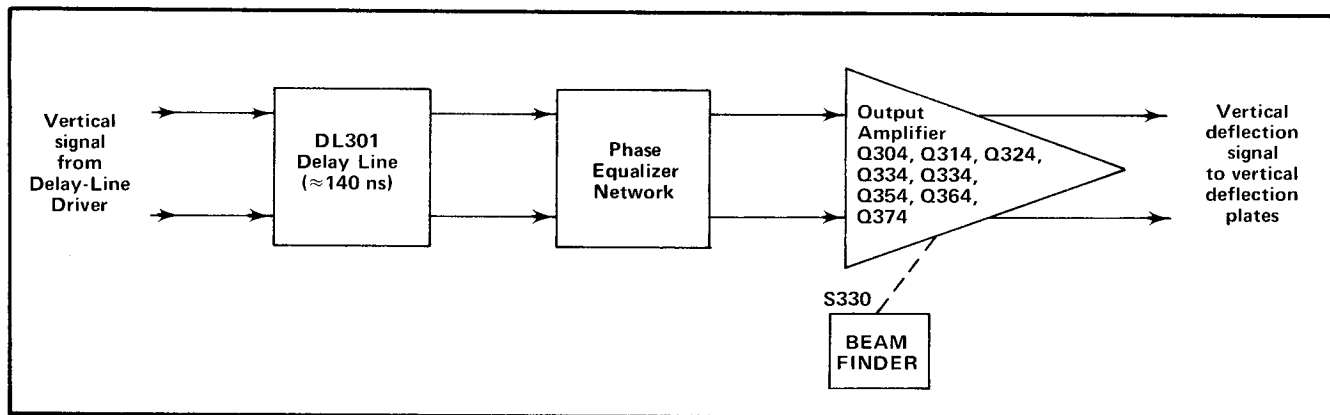


Fig. 3-6. Vertical Output Amplifier detailed block diagram.

sates for the phase distortion of the Delay Line. C303-R303 and C313-R313 in series with the base-emitter resistance of Q304 and Q314 provide the forward termination for the Delay Line.

Output Amplifier

Q304 and Q314 are connected as common-base amplifiers to provide a low input impedance to properly terminate the Delay Line (along with the Phase Equalizer Network). It also provides isolation between the Delay Line and the following stages.

The output of Q304 and Q314 is connected to the bases of Q324 and Q334. The network C326-C327-C328-C336-R328 provides high-frequency peaking to compensate for the capacitive loading of the deflection plates on the output stage. C328, C336, and R328 are adjustable to provide optimum response. BEAM FINDER switch S330 reduces the quiescent current of Q324 and Q334, when pressed, to compress an off-screen display within the graticule area. Normally, the collector current for Q324 and Q334 is supplied through R321, R322 and the parallel combination of R323 and R333. When S330 is pressed, -12-volts is connected to the collector circuit of Q324 and Q334 through R332. This reduces the collector potential of Q324 and Q334 to limit their dynamic range and compress the display vertically within the graticule area. Although this compressed display is nonlinear, it provides a method of locating a signal that is off screen vertically due to incorrect positioning or deflection factor.

Q344 and Q354 amplify the output of Q324 and Q334. The signal at the collectors of Q344 and Q354 is applied to the output transistors, Q364 and Q374, through C344-R344-VR344, C354-R354-VR354, and T357. VR344 and VR354 prevent saturation of Q344 and Q354 to improve the recovery of the Vertical Output Amplifier circuit

when large signals deflect the display off screen. T357 provides high-frequency balance for the Output Amplifier stage. Q364 and Q374 provide the output signal voltage to drive the CRT vertical deflection plates. LR367 and LR377 provide damping for the leads connecting the output signal to the deflection plates.

TRIGGER PREAMP

General

The Trigger Preamp circuit amplifies the internal trigger signal to the level necessary to drive the A and B Trigger Generator circuits. Input signal for the Trigger Preamp circuit is either a sample of the signal applied to Channel 1 or a sample of the composite vertical signal from the Vertical Switching circuit. Fig. 3-7 shows a detailed block diagram of the Trigger Preamp circuit. A schematic of this circuit is shown on diagram 7 at the rear of this manual.

Input Circuitry

The internal trigger signal from the Vertical Deflection System is connected to the Trigger Preamp through INT TRIG switch S230B. When the INT TRIG switch is in the NORM position, the trigger signal is a sample of the composite vertical signal in the Vertical Switching circuit. This signal is obtained from the collector of Q284 and is a sample of the displayed channel (or channels for dual-trace operation). Since the signal source follows the dual-trace switching stage, the NORM trigger signal also includes the chopped switching transients when operating in the CHOP mode. When the INT TRIG switch is in the NORM position, the CH 1 lights DS400 and DS401 are disconnected. Also, the sample of the Channel 1 signal is connected to the CH 1 OUT connector. This output signal can be used to monitor Channel 1 or it can be used to cascade with Channel 2 to provide a one millivolt/division minimum deflection factor (with reduced bandwidth).

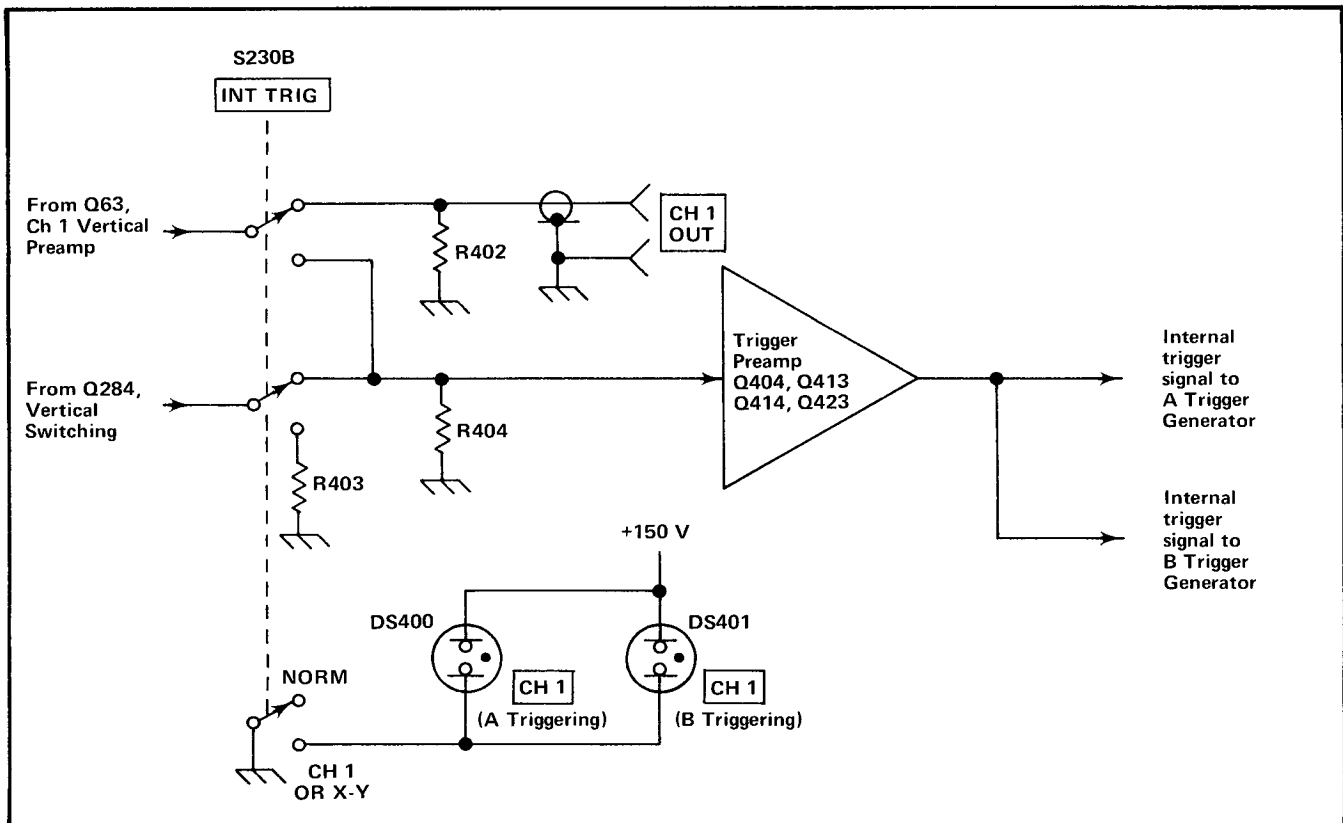


Fig. 3-7. Trigger Preamp detailed block diagram.

In the CH 1 OR X-Y position of the INT TRIG switch, the internal trigger signal is obtained from the emitter of Q63 in the CH 1 Vertical Preamp circuit. Now, the internal trigger signal is a sample of only the signal applied to the CH 1 OR X connector. The CH 1 lights are turned on to indicate that the INT TRIG switch is in the CH 1 OR X-Y position and the CH 1 OUT connector is disconnected from the circuit.

R402, R403, and R404 terminate the coaxial cables from the trigger pickoff stages to provide a constant load for these stages. In the NORM position of the INT TRIG switch, the NORM trigger signal from the Vertical Switching circuit is terminated at the input to the amplifier by R404. The CH 1 OR X-Y trigger signal from the CH 1 Vertical Preamp circuit is terminated at the CH 1 OUT connector by R402. In the CH 1 OR X-Y position, the CH 1 OR X-Y trigger signal is terminated at the input to the amplifier by R404, and the NORM trigger signal is terminated by R403.

Amplifier Circuitry

The internal trigger signal selected by the INT TRIG switch is connected to the base of Q404. Transistor Q404

converts the trigger voltage signal at its base to a current drive for the remainder of the Trigger Preamp. CR408 in the emitter circuit of Q404 provides thermal compensation for the amplifier.

The signal current at the collector of Q404 is connected to the base of Q414. Q413, Q414, and Q423 are connected as a current-driven, voltage-output operational amplifier. The amplified signal at the collector of Q414 is connected directly to the base of Q413, and to the base of Q423 through zener diode VR421. This zener diode provides a DC voltage drop while the signal is connected to the base of Q423 with minimum attenuation. Q413 and Q423 are connected as emitter followers in the complementary symmetry amplifier configuration. This configuration overcomes the basic limitation of emitter followers; inability to provide equal response to both positive- and negative-going portions of a signal. This is remedied in this configuration by using an NPN transistor for one emitter follower, Q413, and a PNP transistor for the other emitter follower, Q423. Since Q413 is an NPN transistor, it responds best to positive-going signals and Q423, being a PNP transistor responds best to negative-going signals. The result is a circuit which has equally fast response to both positive- and negative-going trigger signals while maintaining a low out-

Circuit Description—453A/R453A

put impedance. Feedback from the output of the Trigger Preamp circuit is connected to the base of Q414 through R419. This feedback provides more linear operation. Total overall gain of the Trigger Preamp is about 10. The amplified internal trigger signal is connected to the A and B SOURCE switches through R427 and R429.

A TRIGGER GENERATOR

General

The A Trigger Generator circuit produces trigger pulses to start the A Sweep Generator circuit. These trigger pulses are derived either from the internal trigger signal from the Vertical Deflection System, an external signal connected to the EXT TRIG INPUT connector, or a sample of the line voltage applied to the instrument. Controls are provided in this circuit to select trigger level, slope, coupling, and source. Fig. 3-8 shows a detailed block diagram of the A Trigger Generator circuit. A schematic of this circuit is shown on diagram 8 at the rear of this manual.

Trigger Source

The A SOURCE switch, S430, selects the source of the A trigger signal. Three trigger sources are available; internal,

line, and external. A fourth position of the A SOURCE switch provides 10 times attenuation for the external trigger signal.

The internal trigger signal is obtained from the Vertical Deflection System through the Trigger Preamp circuit. This signal is a sample of the signal(s) applied to the CH 1 OR X and/or CH 2 OR Y connectors. Further selection of the internal trigger source is provided by the INT TRIG switch to provide the internal trigger signal from both channels or from Channel 1 only (see Trigger Preamp discussion for details).

The line trigger is obtained from voltage divider R1104-R1105 in the Power Supply circuit. This sample of the line frequency, about 1.5 volts RMS, is coupled to the A Trigger Generator in the LINE position of the A SOURCE switch. The A COUPLING switch should not be in the LF REJ position when using this trigger source.

External trigger signals applied to the A EXT TRIG INPUT connector can be used to produce a trigger in the EXT and EXT ÷ 10 positions of the A SOURCE switch. Input resistance (DC) is about one megohm in both exter-

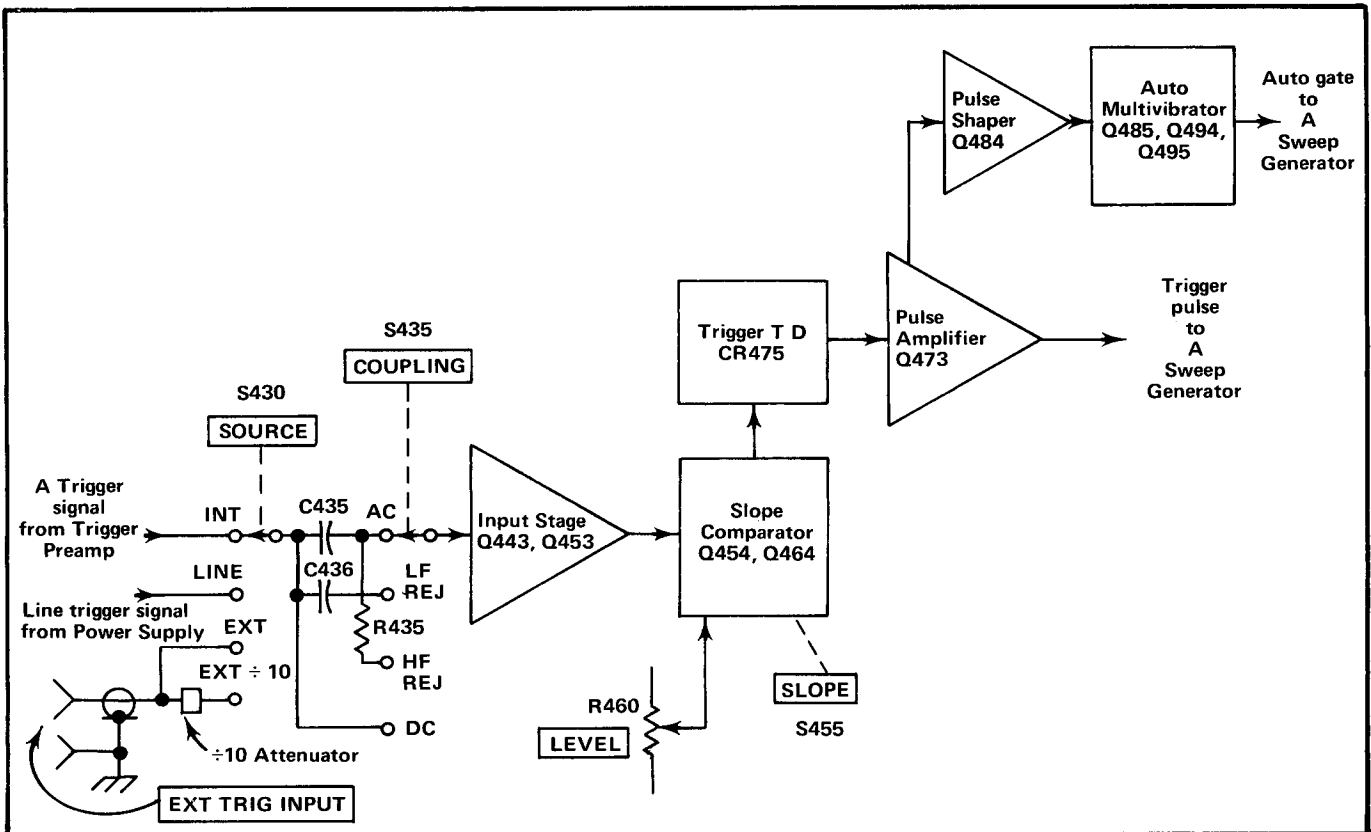


Fig. 3-8. A Trigger Generator detailed block diagram.

nal positions. However, in the LF REJ position of the A COUPLING switch, the medium and high-frequency resistance drops to about 90 kilohms due to the addition of C436-R436 in the circuit. In the EXT \div 10 position, a 10 times frequency compensated attenuator is connected into the input circuit. This attenuator reduces the input signal amplitude 10 times to provide more A LEVEL control range while maintaining the one-megohm X20 pF input RC characteristics.

Trigger Coupling

The A COUPLING switch offers a means of accepting or rejecting certain frequency components of the trigger signal. In the AC and LF REJ positions, the DC component of the trigger signal is blocked by coupling capacitors C435 or C436. In the AC position, frequency components below about 30 hertz are attenuated. In the LF REJ position, frequency components below about 30 kilohertz are attenuated.

The HF REJ position attenuates high-frequency components of the triggering signal. The trigger signal is AC coupled to the input, attenuating signals below about 30 hertz and above about 50 kilohertz. The DC position provides equal coupling for all signals from DC to 60 megahertz.

Input Stage

The trigger signal from the A COUPLING switch is connected to the Input Stage through the network C440-R438-R439-R440-R441. R438-R439 provide the input resistance for this stage. The voltage-divider action of R438-R439 allows about 98% of DC or low frequency signals applied to R438 to be available at the junction of R438 and R439. C440 along with the stray capacitance in the circuit forms an AC divider which maintains about this same voltage division for high-frequency signals. R440 limits the current drive to the gate of FET Q443. Diode CR441 protects the circuit by clamping the gate of Q443 at about -12.5 volts if a high-amplitude negative signal is applied to the EXT TRIG INPUT connector. Over-voltage protection for high-amplitude positive signals is provided by the forward conduction of FET Q443.

Q443 is connected as a source follower to provide a high input impedance and a low output impedance. As a result, this stage provides isolation between the A Trigger Generator circuit and the trigger signal source. The output signal from Q443 is connected to the Slope Comparator stage through emitter follower Q453. Diode CR449, CR459, and VR460 provide protection for the Slope Comparator stage transistors, Q454 and Q464.

Slope Comparator

Q454 and Q464 are connected as a difference amplifier (comparator) to provide selection of the slope and level at

which the sweep is triggered. The reference voltage for the comparator is provided by A LEVEL control R460 and A Trigger Level Center adjustment R462. The A Trigger Level Center adjustment sets the level at the base of Q464 so the display is triggered at the zero-volt DC level of the incoming trigger signal when the A LEVEL control is centered. The A LEVEL control varies the base level of Q464 to select the point on the trigger signal where triggering occurs.

R458 establishes the emitter current of Q454 and Q464. The transistor with the most positive base controls conduction of the comparator. For example, assume that the trigger signal from the Input Stage is positive going and Q454 is forward biased. The increased current flow through R458 produces a larger voltage drop, and the emitters of both Q454 and Q464 go more positive. A more positive voltage at the emitter of Q464 reverse biases this transistor, since its base is held at the voltage set by the A LEVEL control, and its collector current decreases. At the same time, Q454 is forward biased and its collector current increases. Notice that the signal currents at the collectors of Q454 and Q464 are opposite in phase. The sweep can be triggered from either the negative-going or positive-going slope of the input trigger signal by producing the trigger pulse from either the signal at the collector of Q464 for $-$ slope operation or the signal at the collector of Q454 for $+$ slope operation. This selection is made by SLOPE switch S455.

When the A LEVEL control is set to 0 (midrange), the base of Q464 is at about one volt positive, which corresponds to a zero-volt level at the input to this circuit (with correct calibration). The base-emitter drop of Q464 sets the common emitter level of Q454-Q464 to about $+0.3$ volt. Since the base of Q454 must be about 0.65 volt more positive than the emitter before it can conduct, the comparator switches around the zero-volt level of the trigger signal (zero-volt level on the trigger signal corresponds to about one volt positive at this point). As the A LEVEL control is turned clockwise toward $+$, the voltage at the base of Q464 becomes more positive. This increases the current flow through R458 to produce a more positive voltage on the emitters of both Q454 and Q464. Now the trigger signal must rise more positive before Q454 is biased on. The resultant CRT display starts at a more positive point on the displayed signal. When the A LEVEL control is in the $-$ region, the effect is the opposite, to produce a resultant CRT display which starts at a more negative point on the trigger signal.

The slope of the input signal which triggers the A sweep is determined by A SLOPE switch S455. When the A SLOPE switch is set to the $-$ position, the collector of Q454 is connected to the $+12$ -volt supply through CR456 and R467. The anode of CR466 is grounded and it is reverse biased. Now the collector current of Q464 must flow through CR465, R459, the parallel combination CR475 and R468-R469-L469, and R467 to the $+12$ -volt supply

Circuit Description—453A/R453A

(see Fig. 3-9). Since the output pulse from the A Trigger Generator circuit is derived from the negative-going portion of the signal applied to the Trigger TD stage, the sweep is triggered on the negative-going portion of the input trigger signal (signal applied to Trigger TD stage is in phase with the input signal for - slope triggering). When the A SLOPE switch is set to +, conditions are reversed (see Fig. 3-10). Q464 is connected to the +12-volt supply through CR466 and R467. The anode of CR456 is grounded to divert the collector current of Q454 through the Trigger TD stage. The signal applied to the Trigger TD stage is now 180° out of phase with the input trigger signal, so the sweep is triggered on the positive-going portion of the input signal.

Trigger TD

The Trigger TD stage shapes the output of the Slope Comparator to provide a trigger pulse with a fast leading edge. Tunnel diode CR475 is quiescently biased so it

operates in its low-voltage state. The current from one of the transistors in the Slope Comparator stage is diverted through the Trigger TD stage by the A SLOPE switch. As this current increases due to a change in the trigger signal, tunnel diode CR475 switches to its high-voltage state. L469 opposes the sudden change in current, which allows more current to pass through CR475 and switch it more quickly. As the current flow stabilizes, L469 again conducts the major part of the current. However, the current through CR475 remains high enough to hold it in its high-voltage state. The circuit remains in this condition until the current from the Slope Comparator stage decreases due to a change in the trigger signal applied to the input. Then, the current through CR475 decreases and it reverts to its low-voltage state.

Pulse Amplifier

The trigger signal from the Trigger TD stage is connected to the base of Pulse Amplifier Q473 through R472. The

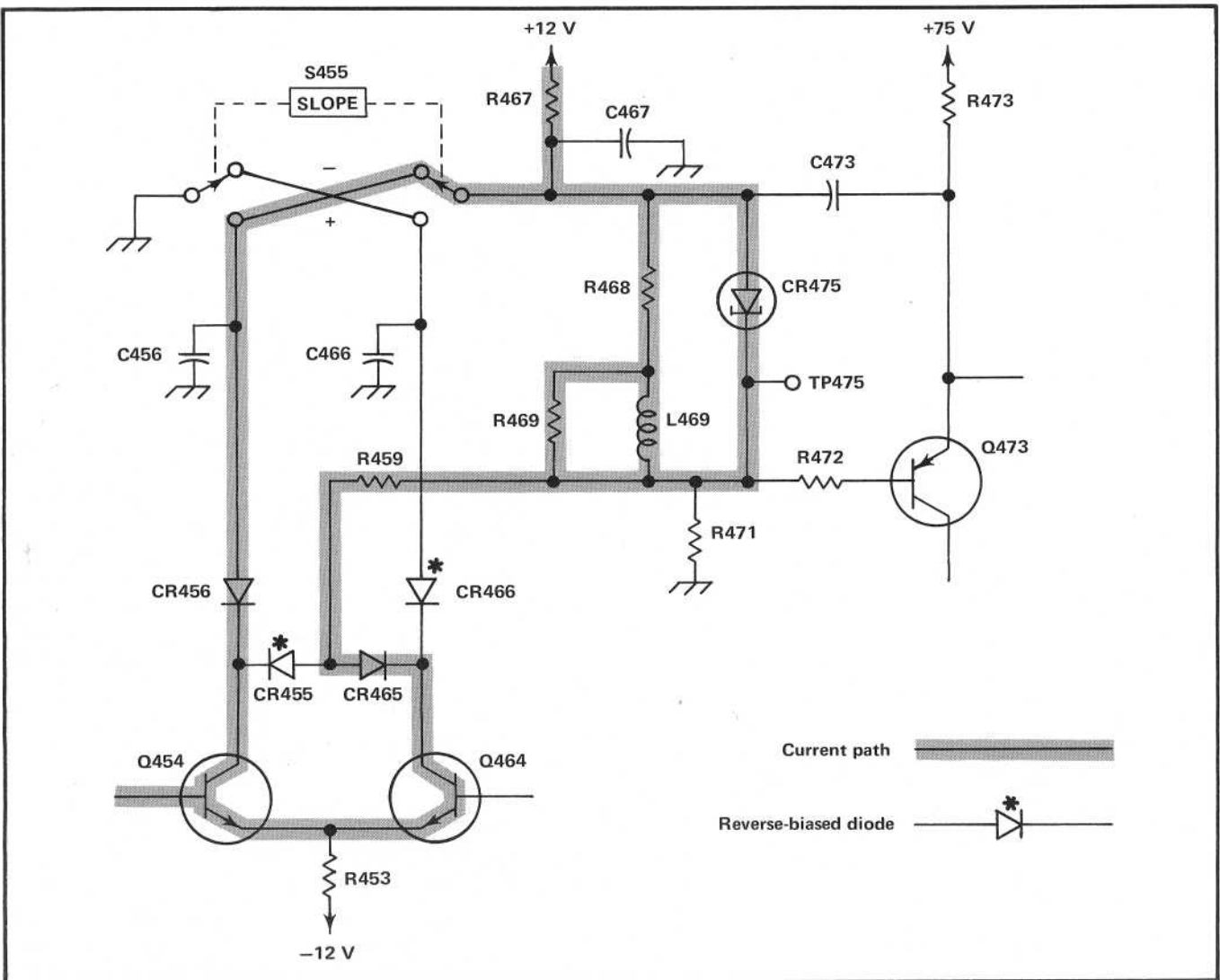


Fig. 3-9. Trigger path for negative-slope triggering (simplified A Trigger Generator diagram).

trigger pulse at this point is basically a negative-going pulse with a fast rise. The width of the pulse depends upon the waveshape of the input signal and the setting of the A LEVEL control. Q473 is connected as an amplifier with the primary of pulse transformer T474 providing the major collector load. The negative-going pulse at the base of Q473 drives it into heavy conduction and the resulting current increase of Q473 flows through T474, R474, Q473, C473, and C467. Due to the short time constant of the RC network involving C473, the current of Q473 quickly returns to the level determined by R473. The resultant signal at the collector of Q473 is a positive-going fast-rise pulse with the width determined by the time constants of the RC network in the circuit. T474 inverts the output pulse to produce a negative-going trigger pulse which is coincident with the rise of the output signal from the Trigger TD stage. This negative-going trigger pulse is connected to the A Sweep Generator circuit through C476-R476. CR474 limits the collector of Q473 from going more positive than about

+0.5 volt. A simultaneous negative-going pulse with the same width as the trigger pulse is available at the emitter of Q473. This pulse is connected to the Auto Pulse Amplifier stage.

Auto Pulse Amplifier

The negative-going trigger pulse from the emitter of Q473 is connected to the base of Q484 through R481. This stage is similar to the Pulse Amplifier stage. Inductor L484 provides the collector load for this stage. The positive-going portion of the trigger pulse is coupled to the Auto Multivibrator stage through CR484. CR483 clamps the collector of Q484 at about -0.5 volt to eliminate negative transients.

Auto Multivibrator

The basic configuration of the Auto Multivibrator stage is a monostable multivibrator made up of Q485 and Q495.

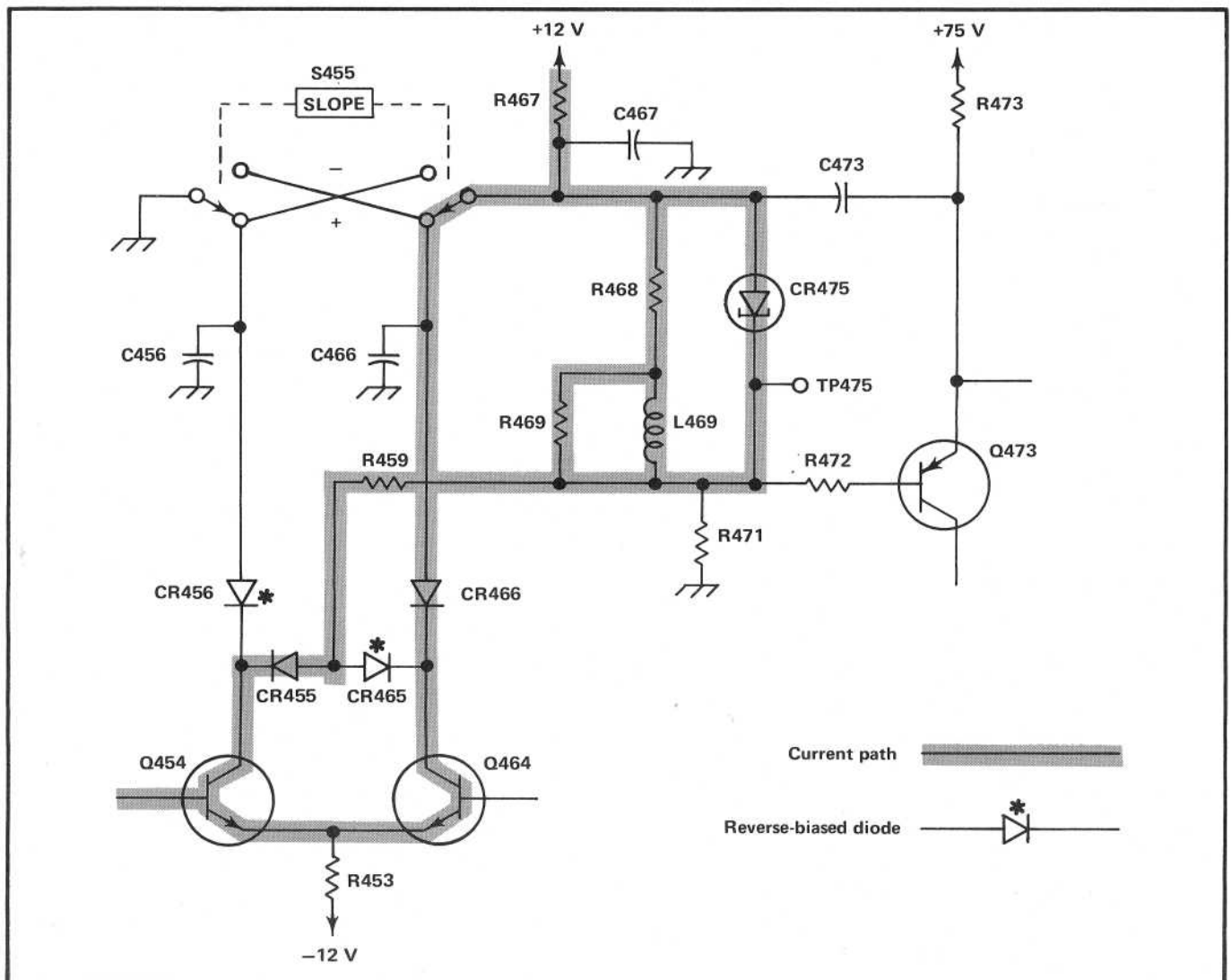


Fig. 3-10. Trigger path for positive-slope triggering (simplified A Trigger Generator diagram).

Circuit Description—453A/R453A

This stage produces the control gate for the auto trigger circuits located in the A Sweep Generator circuit. Under quiescent conditions (no trigger signal), the base of Q495 is near zero volts. The base of Q485 is held at about -0.65 volt by the forward voltage drop of CR484. Since the base of Q495 is the most positive, it conducts and raises the emitter level of Q485 positive enough to hold it off. C485 charges to about $+13$ volts where it is clamped by CR486 and CR493. The base of Q494 is clamped at about $+12.6$ volts by CR493, which reverse biases it. Since there is no current flow through Q494, its collector level goes negative.

When a trigger signal is present, the positive-going pulses from the Auto Pulse Amplifier stage turn Q485 on through CR484. The collector of Q485 goes negative and C485 discharges rapidly through Q485, R490, and R485. As C485 discharges, the current flow through R490 biases Q495 off. When C485 is fully discharged, the current flow through R490 ceases and Q495 comes back on to reset the multivibrator. Now C485 begins to charge towards $+75$ volts through R486. Current also flows through R494, and the base of Q494 goes negative to bias it on. The collector level of Q494 rises positive to produce the auto gate output for the A Sweep Generator circuit.

For low-frequency signals (below about 30 hertz), C485 recharges to about $+13$ volts in about 85 milliseconds. Then, Q494 is biased off to end the auto gate (display free runs or is unstable). However, if a repetitive trigger signal turns Q485 on again before C485 has charged to $+13$ volts, C485 is discharged completely again and once more starts to charge towards $+75$ volts. Since the base of Q494 remains negative enough with a repetitive trigger signal to hold it in conduction, the auto output level is continuous for a stable display (with correct A LEVEL control setting).

A SWEEP GENERATOR

General

The A Sweep Generator circuit produces a sawtooth voltage which is amplified by the Horizontal Amplifier circuit to provide horizontal sweep deflection on the CRT. This output signal is generated on command (trigger pulse) from the A Trigger Generator circuit. The A Sweep Generator circuit also produces an unblanking gate to unblank the CRT during the A sweep time. In addition, this circuit produces several control signals for other circuits within this instrument and several output signals to the side-panel connectors. Fig. 3-11 shows a detailed block diagram of the A Sweep Generator circuit. A schematic of this circuit is shown on diagram 9 at the rear of this manual.

The A SWEEP MODE switch allows three modes of operation. In the NORM TRIG position, a sweep is produced only when a trigger pulse is received from the A

Trigger Generator circuit. Operation in the AUTO TRIG position is much the same as NORM TRIG except that a free-running trace is displayed when a trigger pulse is not present. In the SINGLE SWEEP position, operation is also similar to NORM TRIG except that the sweep is not recurrent. The following circuit description is given with the A SWEEP MODE switch set to NORM TRIG. Difference in operation for the other two modes are then discussed later.

Normal Trigger Mode Operation

Sweep Gate. The negative-going trigger pulse generated by the A Trigger Generator circuit is applied to the Sweep Gate stage through CR501. Tunnel diode CR505 is quiescently biased on in its low-voltage state. When the negative-going trigger pulse is applied to its cathode, the current through CR505 increases and it rapidly switches to its high-voltage state, where it remains until reset by the Sweep Reset Multivibrator stage at the end of the sweep. The negative-going level at the cathode of CR505 is connected to the base of Q504 through C503 and R503. Q504 is turned on and its collector goes positive. This positive-going step is connected to the Disconnect Diode through C509-R509 and to the Output Signal Amplifier through C506-R506.

Output Signal Amplifier. The positive-going gate pulse from the Sweep Gate stage applied to the base of Q514 produces a negative-going pulse at its collector. This pulse is connected to the Z Axis Amplifier circuit through R519 to unblank the CRT during sweep time. It is also connected to the Holdoff Capacitor through R517 and CR517 to discharge it completely at the beginning of each sweep.

The positive-going gate pulse at the base of Q514 is also coupled from the emitter of Q514 to the emitter of Q524. The resulting positive-going signal at the collector of Q524 is coupled to the Vertical Switching circuit through C526 to provide an alternate-trace sync pulse for dual-trace operation. It is also coupled to the A GATE output connector on the side panel through R529. CR528 and CR529 clamp the gate signal so it does not go more than about 0.5 volt negative and 12.5 volts positive.

Disconnect Diode. Disconnect Diode CR533 is quiescently conducting current through R506, R508, R509, R530, and R531. This prevents timing current from Timing Resistor R530 from charging Timing Capacitor C530. The positive-going gate signal from Q504 reverse biases CR533 and interrupts the quiescent current flow. Now the timing current through the Timing Resistor begins to charge Timing Capacitor C530 so the Sawtooth Sweep Generator stage can produce a sawtooth output signal. The positive-going gate signal also reverse biases CR547 to disconnect the Sweep Start Amplifier. The Disconnect Diode is a fast

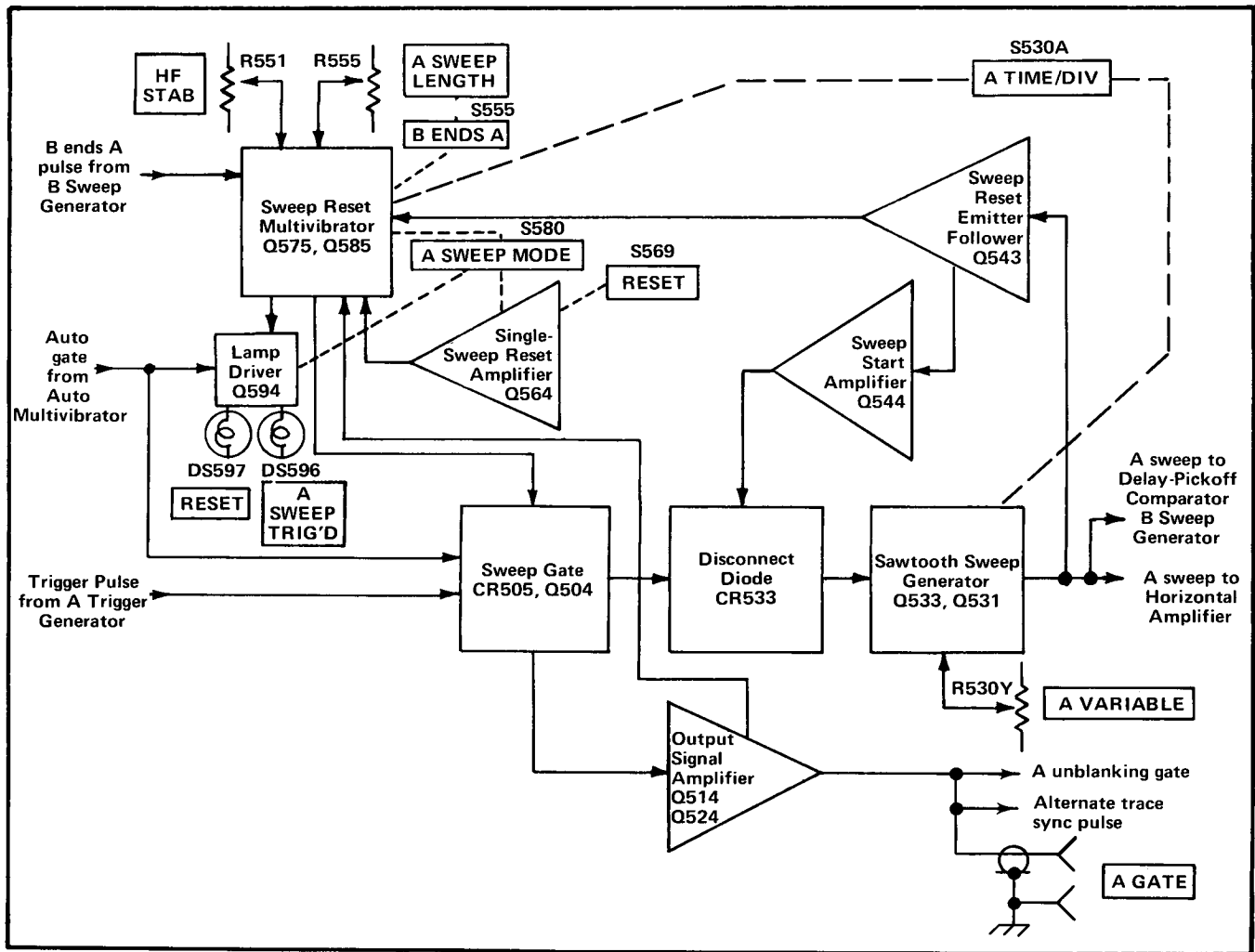


Fig. 3-11. A Sweep Generator detailed block diagram.

turn-off diode with low reverse leakage to reduce switching time and improve timing linearity at the start of the sweep.

Sawtooth Sweep Generator. The basic generator circuit is a Miller Integrator circuit. When the current flow through CR533 is interrupted by the Sweep Gate signal, the Timing Capacitor C530 begins to charge through Timing Resistor R530, and the A Sweep Cal Adjustment R531. The Timing Capacitor and Resistor are selected by the A TIME/DIV switch to change sweep rate. The A Sweep Cal adjustment allows calibration for accurate sweep timing. The A VAR control, R530Y (see Timing Switch diagram), provides variable sweep rates by varying the charge rate of the Timing Capacitor. UNCAL light DS530W (see Diagram 12) indicates when the sweep is not calibrated.

The positive-going voltage at the R530 side of C530 as it charges toward +75 volts is connected to the gate of FET

Q533 through R533. This produces a positive-going output voltage which is connected to the base of Q531 through R536. Q531 amplifies and inverts the voltage change at its base to produce a negative-going sawtooth output. To provide a linear charging rate for the Timing Capacitor, the sweep output signal is connected to the negative side of C530. This feedback provides a constant charging current for C530 which maintains a constant charge rate to produce a linear sawtooth output signal. The output voltage continues to go negative until the circuit is reset through the Sweep Reset Multivibrator stage. The output signal from the collector of Q531 is connected to the Horizontal Amplifier circuit through R538, the Delay Pickoff Comparator stage in the B Sweep Generator circuit through R532, and the B Sweep Start stage through the HORIZONTAL DISPLAY switch.

Sweep Reset Emitter Follower. The negative-going sawtooth voltage at the collector of Q531 is connected to the

Circuit Description—453A/R453A

base of the Sweep Reset Emitter Follower stage Q543. The negative-going signal at the emitter of Q543 is coupled to the Sweep Reset Multivibrator stage to determine sweep length and to the Sweep Start Amplifier stage to set the starting point for the sweep. CR542 connected to the base of Q543 protects this stage during instrument warmup.

Sweep Start Amplifier. The signal at the emitter of Q543 goes negative along with the applied sawtooth signal. This increases the forward bias on CR543, which in turn decreases the forward bias on CR545 as the sawtooth goes negative. When the anode of CR543 reaches a level about one volt more negative than the level on the base of Q544, it is reverse biased to interrupt the current flow through Q544.

The circuit remains in this condition until after the sweep retrace is complete. As the voltage at the emitter of Q543 returns to its original DC level at the end of the sweep, CR545 is again forward biased and Q544 conducts through CR547 to set the quiescent current through the Disconnect Diode CR533. This establishes the correct starting point for the sweep. CR546 clamps the collector of Q544 at about +0.5 volt. This reduces the voltage swing at the collector of Q544 and improves the response time. Sweep Start adjustment R758 (in the B Sweep Generator circuit) sets the base voltage level of Q544. The collector of Q531 is held at this same voltage level through the feedback loop comprised of Q533 and Q531, thereby setting the starting point of the sawtooth output signal. The level established by the Sweep Start adjustment is also connected to the B Sweep Start Amplifier so the B sweep starts at the same voltage level as the A sweep (except in MIXED).

Sweep Reset Multivibrator. The negative-going sawtooth signal at the emitter of Q543 is coupled to the cathodes of CR555 and CR556. These diodes are quiescently reverse biased at the start of the sweep. As the sawtooth voltage at its cathode goes negative, CR555 is forward biased at a level about 0.5 volt more negative than the base level of Q575 (A SWEEP LENGTH control in FULL position). Then the negative-going sawtooth signal from the Sweep Reset Emitter Follower stage is connected to the base of Q575. Q575 and Q585 are connected as a Schmitt bistable multivibrator. Quiescently, at the start of the sweep, Q585 is conducting and Q575 is biased off to produce a negative level at its collector. This negative level allows Sweep Gate tunnel diode CR505 to be switched to produce a sweep as discussed previously. When the negative-going sweep signal is connected to the base of Q575 through CR555, Q575 is eventually biased on and Q585 is biased off by the emitter coupling between Q575 and Q585. The collector of Q575 rises positive and CR505 is switched back to its low-voltage state through R502. CR505 is held in its low-voltage state so it cannot accept incoming trigger pulses until after the Sweep Reset Multivibrator stage is reset. This ends the Sweep Gate stage output and the Disconnect Amplifier

stage is turned on to rapidly discharge the Timing Capacitor and pull the gate of Q533 rapidly negative to its original level to produce the retrace portion of the sawtooth signal. The Sawtooth Sweep Generator stage is now ready to produce another sweep as soon as the Sweep Reset Multivibrator stage is reset and another trigger pulse is received.

When Q575 is turned on to end the sweep, it remains in conduction for a period of time to establish a holdoff period and allow all circuits to return to their original conditions before the next sweep is produced. The holdoff time is determined by the charge rate of Holdoff Capacitor C550. At the start of the sweep, C550 is completely discharged by the unblanking gate at the collector of Q514. It is held at this level throughout the sweep time. When the Sweep Gate output ends, Q514 is cut off and C550 begins to charge toward +75 volts through R552 and R551. The positive-going voltage across the Holdoff Capacitor as it charges is connected to the base of Q575 through CR552 and VR559. When the base of Q575 rises positive enough so it is reverse biased, its collector level drops negative and Q585 comes back into conduction. The bias on the Sweep Gate tunnel diode CR505 returns to a level that allows it to accept the next trigger pulse (CR505 is enabled). Holdoff Capacitor C550 is changed by the A TIME/DIV switch for the various sweep rates to provide the correct holdoff time. Diagram 12 shows a complete diagram of the A TIME/DIV switch.

As the A SWEEP LENGTH control is rotated counterclockwise from the FULL position, R555 places a more positive level on the anode of CR556 than is on the anode of CR555 so CR555 remains reverse biased. The Sweep Reset Multivibrator is reset as described for FULL sweep length operation at the point where CR556 (instead of CR555) is forward biased. Since this occurs at a more positive level on the negative-going sawtooth, the displayed sweep is shorter. Thus, R555 provides a variable sweep length for the A sweep (from about 11 divisions in the FULL position to about four divisions in the fully clockwise position—not in B ENDS A detent). In the B ENDS A position (fully counterclockwise), a negative-going pulse from the B Sweep Generator circuit is connected to the base of Q575 through CR575 at the end of the B sweep time. If the A sweep is still running, this negative-going pulse turns Q575 on to end the A sweep also. Since the A sweep ends immediately following the end of the B sweep, this position provides the maximum repetition rate (brightest trace) for Delayed Sweep mode operation.

The HF STAB control, R551, varies the charging rate of the Holdoff Capacitor to provide a stable display at fast sweep rates. This change in holdoff allows sweep synchronization for less display jitter at the faster sweep rates. The HF STAB control has little effect at slow sweep rates.

Lamp Driver. The auto gate level from the Auto Multivibrator stage in the A Trigger Generator circuit is connected to Lamp Driver stage Q594, through CR591 and CR594. This gate level is coincident with the trigger pulse generated by the A Trigger Generator circuit and is present only when the instrument is correctly triggered. The positive-going auto-gate level saturates Q594 and its collector goes negative to about zero volts. This applies about 12 volts across DS596, A SWEEP TRIG'D light, and it comes on. This light remains on as long as the auto-gate level is present. When the auto-gate level goes negative because the instrument is no longer triggered, CR595 clamps the base level of Q594 at about -0.5 volt and Q594 is reverse biased. The collector of Q594 rises positive and DS596 goes off.

Auto Trigger Mode Operation

Operation of the A Sweep Generator circuit in the AUTO TRIG position of the A SWEEP MODE switch is the same as for the NORM TRIG position just described when a trigger pulse is applied. However, when a trigger pulse is not present, a free-running reference trace is produced in the AUTO TRIG mode. This occurs as follows:

The auto-gate level from the Auto Multivibrator stage in the A Trigger Generator circuit is also connected to CR592. When the auto-gate level is positive (instrument triggered), the current flowing through CR592 and R593 reverse biases CR593 and Sweep Gate tunnel diode CR505 operates as previously described for NORM TRIG operation. However, when the instrument is not triggered, the auto-gate level drops negative and the reduction in current through CR592 and R593 allows CR593 to become forward biased. Now, when the Sweep Reset Multivibrator stage resets at the end of the holdoff period, the additional current from R593-CR593 flows through CR505 and is sufficient to automatically switch the Sweep Gate tunnel diode back into its high-voltage state. The result is that the A Sweep Generator circuit is automatically retriggered at the end of each holdoff period and a free-running sweep is produced. Since the sweep free runs at the sweep rate of the A Sweep Generator circuit (as selected by the A TIME/DIV switch), a bright reference trace is produced even at fast sweep rates.

Single Sweep Operation

General. Operation of the Sweep Generator in the SINGLE SWEEP position of the A SWEEP MODE switch is similar to operation in the other modes. However, after one sweep has been produced, the Sweep Reset Multivibrator stage does not reset. All succeeding trigger pulses are locked out until the RESET button is pressed.

In the SINGLE SWEEP position, the A SWEEP MODE switch disconnects the charging current for the Holdoff Capacitor. Now, Q575 remains on when it is forward biased

through CR555 or CR556 at the end of the sweep. With Q575 on, CR505 is held in its low-voltage state to lock out any incoming trigger pulses. The circuit remains in this condition until reset by the Single-Sweep Reset Amplifier stage.

Single-Sweep Reset Amplifier. Single-Sweep Reset Amplifier Q564 produces a pulse to reset the Sweep Reset Multivibrator stage so another sweep can be produced in the SINGLE SWEEP mode of operation. Quiescently, Q564 is biased off and the RESET switch is open. When the RESET button is pressed, DS568 ignites and the voltage at the base of Q564 goes negative. Q564 saturates and produces a positive-going output pulse. This pulse has sufficient amplitude to shut off Q575 and allow Q585 to conduct and enable Sweep Gate tunnel diode CR505. Now the A Sweep Generator circuit can be triggered when the next trigger pulse is received.

Lamp Driver. In the SINGLE SWEEP mode, the cathode of CR591 is connected to ground to block the incoming auto-gate level. A SWEEP TRIG'D light DS596 is disconnected from the collector of Q594 and RESET light DS597 is connected into the circuit. The anode of CR595 is also disconnected from ground. Now the condition of Q594 is determined by the Sweep Reset Multivibrator stage. When Q585 is off before the RESET button is pressed, the collector level of Q585 is negative. The current through R594-CR595-R587-R588 sets the base level of Q594 negative enough to bias it off. However, when the RESET button is pressed and Q585 turns on, its collector goes positive. This positive level allows the base of Q594 to go positive also and it is biased on. The collector of Q594 goes negative and the RESET light comes on. Q594 and the RESET light remain on until Q585 turns off again at the end of the next sweep.

B TRIGGER GENERATOR

General

The B Trigger Generator circuit is basically the same as the A Trigger Generator circuit. Only the differences between the two circuits are discussed here. Portions of the circuit not described in the following discussion operate in the same manner as for the A Trigger Generator circuit (corresponding circuit numbers are assigned in the 600-699 range). Fig. 3-12 shows a detailed block diagram of the B Trigger Generator circuit. A schematic of this circuit is shown on diagram 10 at the rear of this manual.

Input Stage

The B Input Stage operates in basically the same manner as described for the A Trigger Generator circuit. However, in the B Trigger Generator circuit, HORIZ DISPLAY switch S801A and CR638 block the B Trigger Generator input

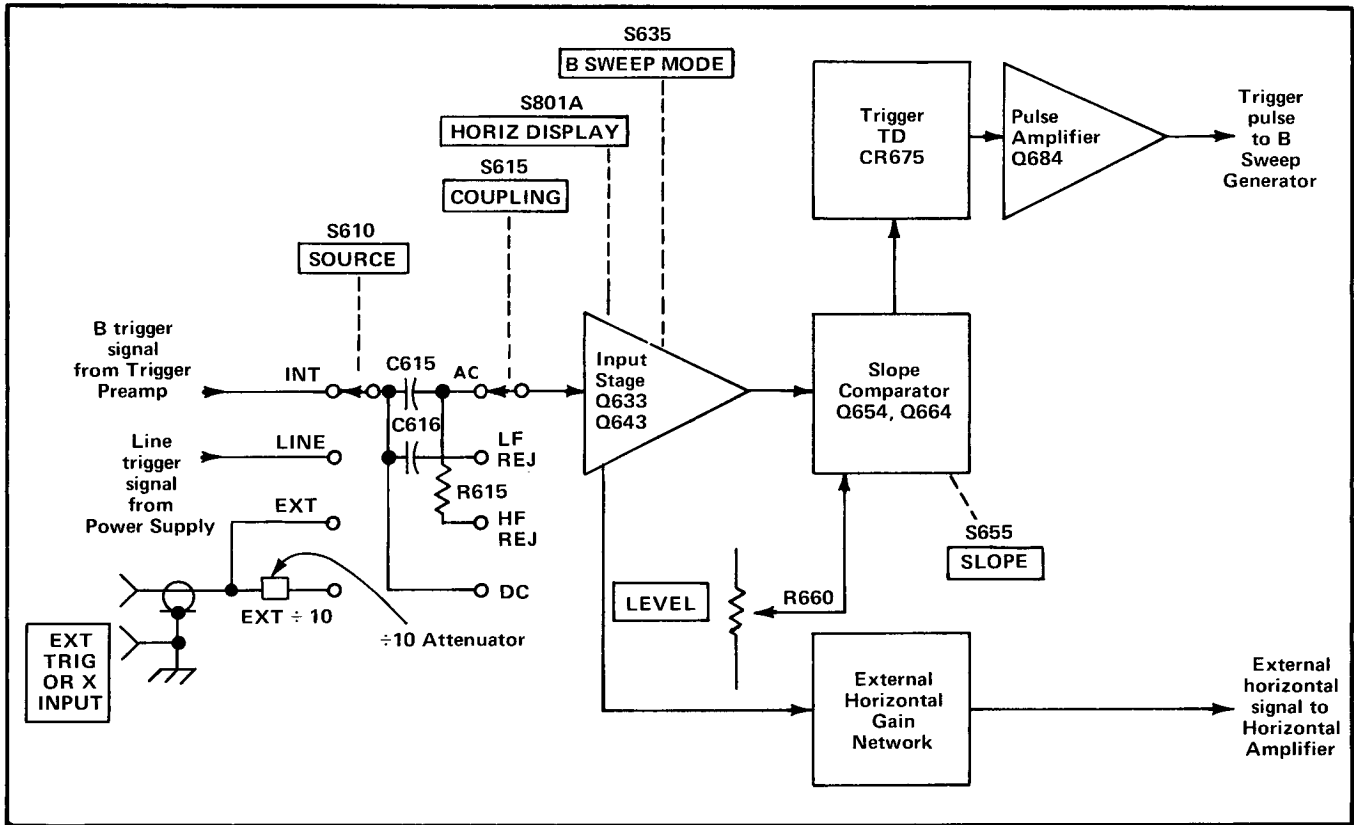


Fig. 3-12. B Trigger Generator detailed block diagram.

signal in the modes where B triggering is not desired. In the A position of the HORIZ DISPLAY switch, -12 volts is connected to the cathode of CR635 and it is forward biased. Since the cathode of CR638 is connected to +12 volts through R638, CR638 is reverse biased and it blocks the trigger signal. In the A INTEN DURING B, B (DELAYED SWEEP), and MIXED positions, a second switch, B SWEEP MODE S635 determines whether the B trigger signal is blocked or passed to the Slope Comparator stage. If the B SWEEP MODE switch is in the B STARTS AFTER DELAY TIME position, the trigger signal is blocked as in the A position. However, the B Sweep Generator essentially free runs in this position as controlled by another portion of the B SWEEP MODE switch located in the B Sweep Generator circuit (see B Sweep Generator discussion). In the TRIGGERABLE AFTER DELAY TIME position, -12 volts is connected to the cathode of CR638 through R639 rather than to CR635. This forward biases CR638 and allows the B trigger signal to pass to the B Slope Comparator stage.

In all positions of the HORIZ DISPLAY switch except X-Y, CR641 is back biased since it is connected to +12 volts through R641. In the X-Y position, CR638 is reverse biased because its cathode rises positive toward +12 volts applied through R638. Therefore, the trigger signal can not pass through CR638. CR641 is forward biased by -12 volts

connected to its cathode through R642 by S801A. The signal from the Input Stage is connected to the Horizontal Amplifier through CR641 and External Horizontal Gain Network R644-R645-R646. Gain of the External Horizontal circuit is set by R645, Ext Horiz Gain, so a signal applied to the CH 1 OR X connector produces the indicated horizontal deflection.

The external horizontal signal can be obtained either externally from the B EXT TRIG OR X INPUT connector when the B SOURCE switch is set to EXT or EXT ÷ 10, or internally from Channel 1 when the INT TRIG switch is in the CH 1 OR X-Y position and the B SOURCE switch is set to INT.

Pulse Amplifier

The Pulse Amplifier in the B Trigger Generator operates much the same as in the A Trigger Generator. However, since there is no Auto circuit in the B Trigger Generator, a pulse is available only at the collector of Q684. The output pulse is applied to the B Sweep Generator through T686 and R688-C688.

B SWEEP GENERATOR

General

The B Sweep Generator circuit is basically the same as the A Sweep Generator circuit. Only the differences between the two circuits are discussed here. The following circuits operate as described for the A Sweep Generator (corresponding circuit numbers assigned in the 700-799 range): Sweep Gate (CR705, Q704), Disconnect Diode (CR742), Sawtooth Sweep Generator (Q743 and Q741), and the Sweep Reset Emitter Follower (Q753). Fig. 3-13 shows a detailed block diagram of the B Sweep Generator circuit. A schematic of this circuit is shown on diagram 11 at the rear of this manual.

Output Signal Amplifier

Basically, the B Output Signal Amplifier is the same as the corresponding circuit in the A Sweep Generator circuit. Two unblanking gates are available from the collector of Q714. An unblanking gate is connected to the Z Axis Amplifier circuit through R717 and the HORIZ DISPLAY switch to unblank the CRT to display the B sweep. For A INTEN DURING B operation, additional unblanking current is added to the A unblanking gate during the B sweep time. This produces a display which is partially unblanked during A sweep time and further unblanked during B sweep time to produce a display which has an intensified portion coincident with the B sweep time.

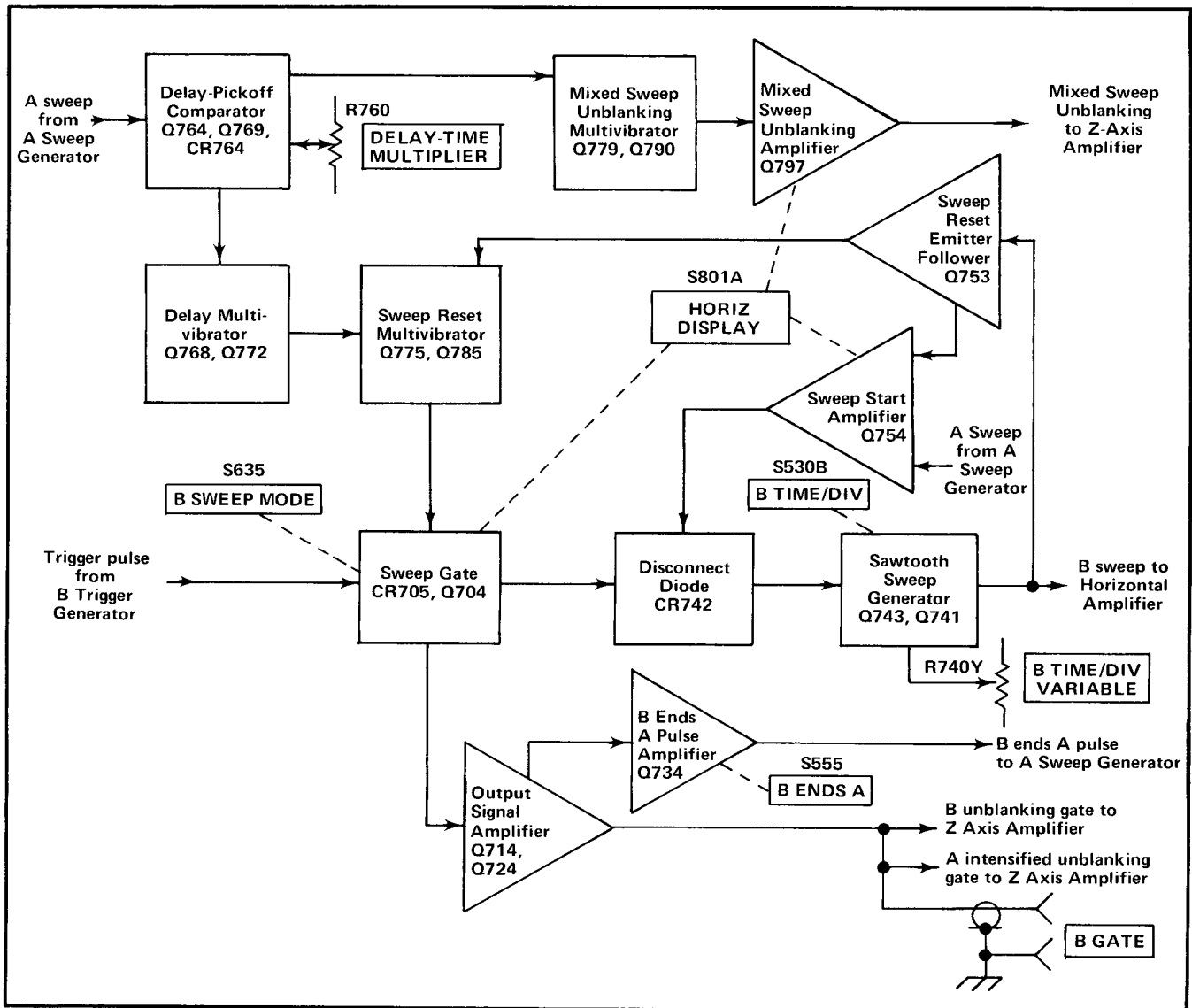


Fig. 3-13. B Sweep Generator detailed block diagram.

B Ends A Pulse Amplifier

The positive-going voltage as the B unblanking gate ends is coupled to B Ends A Pulse Amplifier Q734 through C731 and CR731. When the A SWEEP LENGTH control is in the B ENDS A position, this pulse saturates Q734 to produce a negative-going output pulse at its collector. This negative-going pulse is connected to the A Sweep Reset Multivibrator stage to reset the A sweep at the end of the B sweep for maximum delayed sweep repetition rate.

Delay-Pickoff Comparator

The Delay-Pickoff Comparator stage allows selection of the amount of delay from the start of the A sweep before the B Sweep Generator is turned on. This stage allows the start of B sweep to be delayed between 0.20 and 10.20 times the setting of the A TIME/DIV switch. Then, the B Sweep Generator is turned on and operates at a sweep rate independent of the A Sweep Generator (determined by setting of B TIME/DIV switch).

Q764A and B are connected as a voltage comparator. In this configuration, the transistor with the most positive base controls conduction. A dual transistor, Q764, and a dual diode, CR764, provide temperature stability for the comparator circuit. Q769 maintains a constant current through the conducting transistor. Reference voltage for the comparator circuit is provided by DELAY-TIME MULTIPLIER control R760. The voltage to this control is filtered by R759-C759 to hold it constant and allow precise delay pickoff. The instrument is calibrated so that the major dial markings of R760 correspond to the major divisions of horizontal deflection on the graticule. For example, if the DELAY-TIME MULTIPLIER dial is set to 5.00, the B Sweep Generator is delayed five divisions of the A sweep time before it can produce a sweep (B sweep delay time equals five times setting of A TIME/DIV switch).

The output sawtooth from the A Sawtooth Sweep Generator stage is connected to the base of Q764A. The quiescent level of the A sawtooth biases Q764A on and its collector is negative enough to hold Q772 in the Delay Multivibrator stage in conduction. As the A sweep output sawtooth begins to run down, the base of Q764A also goes negative. When it goes more negative than the level at the base of Q764B (established by the DELAY-TIME MULTIPLIER control), Q764B takes over conduction of the comparator and Q764A shuts off. This also switches the Delay Multivibrator stage to produce a negative-going reset pulse to the B Sweep Reset Multivibrator.

When the A sweep resets, Q764A is again returned to conduction and Q764B is turned off. This also resets the Delay Multivibrator to produce a positive-going output pulse. If the B sweep is still running, this positive-going

pulse forces the B Sweep Reset Multivibrator to reset and end the B sweep also.

Delay Multivibrator

The Delay Multivibrator, Q768 and Q772, provides a lockout for the B Sweep Generator circuit during the A Sweep Generator reset and holdoff time to allow accurate delayed-sweep measurements when the DELAY-TIME MULTIPLIER dial is set near 0. This stage prevents the B Sweep Generator from being triggered before the A Sweep Generator is triggered (B Sweep Generator must always be triggered after the A Sweep Generator is triggered). This circuit also produces a pulse which resets the B Sweep Reset Multivibrator stage after the delay period so the B Sweep Gate tunnel diode can be enabled to produce a sweep.

Transistors Q768 and Q772 are connected as a Schmitt bistable multivibrator. Quiescently, Q772 is held on by the negative level at the collector of Q764A and Q768 remains off. The circuit remains in this condition until the incoming A sweep switches the Delay-Pickoff Comparator (see Delay-Pickoff Comparator discussion). Then, the base of Q772 goes positive and it turns off. At the same time, the base of Q768 is pulled negative by the collector level of Q764B and it turns on. The collector of Q772 goes negative and a negative-going output pulse is coupled to the B Sweep Reset Multivibrator stage through C774. This pulse resets the B Sweep Reset Multivibrator which in turn enables the B Sweep Gate stage.

Mixed Sweep Unblanking Multivibrator

Transistors Q779 and Q790 comprise a bistable multivibrator very similar in configuration to the Sweep Reset Multivibrator. The purpose of the Mixed Sweep Unblanking Multivibrator is to provide additional unblanking during the B sweep portion of a mixed sweep display. Because the B Sweep Generator is normally running at a faster sweep rate than the A Sweep Generator in a mixed sweep display, this additional unblanking reduces the intensity differences between the two parts of the display.

During the A Sweep portion of a mixed sweep display, transistor Q779 is off and Q790 is on. At the end of the delay time a negative pulse is coupled to the base of Q779 from the collector of Q772 by capacitor C774. Q779 is turned on and its collector goes positive. This positive movement is coupled to the base of Q790 through C780-R780, and Q790 turns off. At the same time that Q779 is turned on, the pulse from C774 turns Q775 on and its collector goes positive. The negative movement of the collector of Q790 and the positive movement of the collector of Q775 are added together so that the net change at the base of Q797 is an approximate 0.6 volt more positive

level. The increased conduction of Q797 causes its collector to step slightly more negative to further unblank the CRT display. Then at the end of the B Sweep time, Q790 turns on and Q775 turns off. The negative movement at the base of Q797 is sufficient to cause total blanking of the CRT so any remaining part of A Sweep is not seen.

Mixed Sweep Unblanking Amplifier

In the MIXED position of the HORIZ DISPLAY switch, +12 volts is applied to the collector of the Mixed Sweep Blanking Amplifier Q797 through collector load resistor R797. This activates Q797 so it can amplify the mixed-sweep unblanking gate at its base. The output at the collector of Q797 is added to the A unblanking gate (see Horizontal Display Switch, Diagram 14) to produce a composite blanking gate for the Z-Axis Amplifier.

Sweep Start Amplifier

In all positions of the HORIZ DISPLAY switch except MIXED, the operation of B Sweep Start Amplifier Q754 is the same as described for the A Sweep Start Amplifier stage. In the MIXED position, the Sweep Start control R758 is disconnected from the base of Q754 and the A sweep sawtooth is applied. Now, the point at which the B Sweep Generator will start generating its sawtooth waveform is constantly being changed by the A sweep sawtooth. The output waveform from the B Sweep Generator takes the form of a composite sawtooth waveform with the first and last parts occurring at a rate determined by the A Sweep Generator (last part of composite sweep blanked out), and the middle part at a rate determined by the B Sweep Generator.

Sweep Reset Multivibrator

The basic B Sweep Reset Multivibrator configuration and operation is the same as for the A Sweep Generator. However, several differences do exist. The B Sweep Reset Multivibrator does not have a sweep length network for variable sweep length or a Holdoff Capacitor and associated circuit to reset the B Sweep Reset Multivibrator after the retrace. Instead, the negative-going sweep from the B Sweep Reset Emitter Follower, Q753, is connected to the base of Q785 through CR748. Diode CR748 is forward biased when the sweep voltage at the emitter of Q753 drops about 0.5 volt more negative than the level at the base of Q785 established by voltage divider R784-R785 between +12 volts and the collector of Q775. This negative-going sawtooth turns on Q785, and its collector goes positive to switch B Sweep Gate tunnel diode CR705 to its low-voltage state, which resets the B Sweep. Q785 remains on and holds the B Sweep Gate tunnel diode locked out until the B Sweep Reset Multivibrator is reset by the Delay Multivibrator.

When the B Sweep Reset Multivibrator is reset by the Delay Multivibrator, Q775 comes on and Q785 turns off. The collector of Q785 goes negative and B Sweep Gate tunnel diode CR705 is enabled. The state in which CR705 remains depends upon the B SWEEP MODE switch and the HORIZ DISPLAY switch. When B SWEEP MODE switch S635 is set to the TRIGGERABLE AFTER DELAY TIME position, CR705 is biased so it can be switched to its high-voltage state by the next trigger pulse from the B Trigger Generator. However, in the B STARTS AFTER DELAY TIME position, the setting of HORIZ DISPLAY switch S801A determines operation of the B Sweep Gate tunnel diode. In the A position, the B trigger pulses are blocked in the B Trigger Generator circuit so the B Sweep Generator cannot be triggered and does not produce a sweep. In the remaining positions of S801A, -12 volts is connected to the cathode of CR705 through R786 and R789. This voltage pulls the cathode of CR705 negative enough so it automatically switches to its high-voltage state after it is enabled by the B Sweep Reset Multivibrator stage. This produces a free-running B sweep reset similar to the no trigger AUTO TRIG mode in the A Sweep Generator. However, since the B Sweep is reset (and automatically re-triggered) at a fixed point on the A sweep sawtooth, the display is relatively stable. The best delayed sweep stability is provided in the TRIGGERABLE AFTER DELAY TIME position, since the B sweep is triggered by the trigger signal in this mode.

HORIZONTAL AMPLIFIER

General

The Horizontal Amplifier circuit provides the output signal to the CRT horizontal deflection plates. In all positions of the HORIZ DISPLAY switch except X-Y, the horizontal deflection signal is a sawtooth from either the A Sweep Generator circuit or the B Sweep Generator circuit. In the X-Y position, the horizontal deflection signal is obtained from the Input Stage of the B Trigger Generator. In addition, this circuit contains the horizontal magnifier circuit and the horizontal positioning network. Fig. 3-14 shows a detailed block diagram of the Horizontal Amplifier circuit. A schematic of this circuit is shown on diagram 13 at the rear of this manual.

Input Amplifiers

The input signal for the Horizontal Amplifier is selected by HORIZ DISPLAY switch S801A. In the A and A INTEN DURING B positions of the HORIZ DISPLAY switch, the sawtooth from the A Sweep Generator is connected to the base of the - Input Amplifier, Q814, through R803. In the B (DELAYED SWEEP) position, the B sawtooth is connected to the base of Q814 and in the MIXED position, the composite sawtooth from the B Sweep Generator is connected to the base of Q814. Whichever sawtooth signal is connected to the base of Q814 produces a

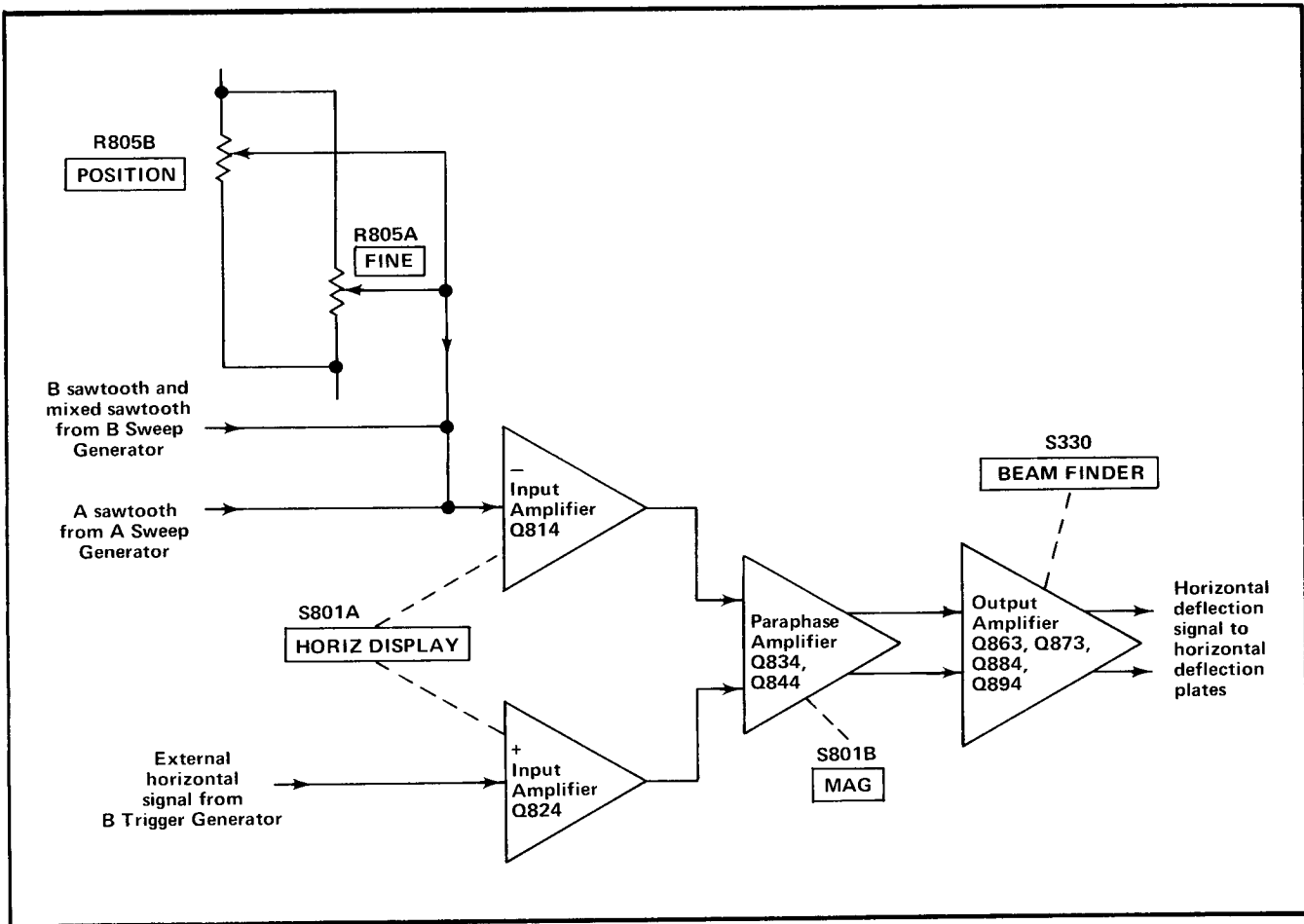


Fig. 3-14. Horizontal Amplifier detailed block diagram.

current change which is amplified to produce a positive-going sawtooth voltage at the collector. This positive-going sawtooth signal is connected to the base of Q834 in the Paraphase Amplifier stage.

In the X-Y position of the HORIZ DISPLAY switch, the external horizontal signal from the B Trigger Generator circuit is connected to the base of the + Input Amplifier, Q824, through R821. The A and B sawtooth signals are grounded by the HORIZ DISPLAY switch. The B SOURCE switch selects either the internal signal from Channel 1 (INT TRIG switch set to CH 1 OR X-Y) or an external signal connected to the EXT TRIG OR X INPUT connector. When the internal signal is selected, the Channel 1 deflection factor as indicated by the CH 1 VOLTS/DIV switch applies as Horizontal Volts/Division. More information on the external horizontal circuitry is contained in the B Trigger Generator circuit discussion.

Horizontal positioning is provided by POSITION control R805A, and FINE control R805B connected to the base of

Q814. These controls vary the quiescent DC level at the base of Q814 which in turn sets the DC level at the horizontal deflection plates to determine the horizontal position of the trace. C804-R804 eliminate common-mode noise from the position controls.

Paraphase Amplifier

The output of the + and - Input Amplifier stages is connected to Paraphase Amplifier Q834 and Q844. This stage converts the single-ended input signal from either Input Amplifier stage to a push-pull output signal which is necessary to drive the horizontal deflection plates of the CRT. In all positions of the HORIZ DISPLAY switch except X-Y, a positive-going sawtooth signal is connected to the base of Q834 through Q814. This produces a negative-going sawtooth voltage at the collector of Q834. At the same time, the emitter of Q834 goes positive and this change is connected to the emitter of Q844 through the gain-setting network, R835-R836-R845-R846. In all positions of the HORIZ DISPLAY switch except X-Y, no signal is connected to the base of Q844 through Q824 so Q844

operates as the emitter-driven section of a paraphase amplifier. Then, the positive-going change at its emitter is amplified to produce a positive-going sawtooth signal at the collector. Thus the single-ended input sawtooth signal has been amplified and is available as a push-pull signal at the collectors of Q834 and Q844.

In the X-Y position of the HORIZ DISPLAY switch, the external horizontal deflection signal is connected to the base of Q844 through Q824 and the sawtooth signal at the base of Q814 is disconnected. Now, the circuit operates much the same as just described for a sawtooth input. A positive-going external horizontal deflection signal produces a negative-going change at the base of Q844 which decreases the current flow through this transistor. The collector of Q844 goes positive while the emitter-coupled signal to Q834 produces a negative-going change at the collector of Q834.

This stage also provides adjustment to set the normal and magnified gain of the Horizontal Amplifier circuit, and the MAG switch to provide a horizontal sweep which is magnified 10 times. For normal sweep operation (MAG switch set to OFF), R835 and R836 control the emitter degeneration between Q834 and Q844 to set the gain of the stage. R835, Normal Gain, is adjusted to provide calibrated sweep rates. When MAG switch S801B is set to the X10 position, R845 and R846 are connected in parallel with R835 and R836. This additional resistance decreases the emitter degeneration of this stage to increase the gain of the circuit 10 times. R845, Mag Gain, is adjusted to provide calibrated magnified sweep rates. When the MAG switch is set to X10, MAG ON light DS849 is connected to the +150-volt supply through R849. DS849 ignites to indicate that the sweep is magnified. In the X-Y position of the HORIZ DISPLAY switch, the magnifier is connected into the circuit by S801A so the horizontal gain is correct for external horizontal operation regardless of the setting of the MAG switch. However, both sides of DS849 are connected to ground so it can not ignite.

Output Amplifier

The push-pull output of the Paraphase Amplifier is connected to the Output Amplifier. Each half of the Output Amplifier can be considered as a single-ended, feedback amplifier which amplifies the signal current at its input to produce a voltage output to drive the horizontal deflection plates of the CRT. The amplifiers have a low input impedance and require very little voltage change at the input to produce the desired output change. Diodes CR851-CR852 and CR861-CR871 protect the amplifier from being overdriven by excessive current swing at the collectors of Q834 and Q844. Negative feedback is provided from the collectors of the final transistors, Q884 and Q894, to the bases of the input transistors through C882-R882 and C892-R892. C882 and C892 adjust the transient response of the amplifier so it has good linearity at fast sweep rates.

Mag Register adjustment R855 balances the quiescent DC current to the base of Q863 and Q873 so a center-screen display does not change position when the MAG switch is changed from X10 to OFF.

BEAM FINDER switch S330 reduces horizontal scan by limiting the current available to Q884 and Q894. Normally the collectors of these transistors are returned to +150 volts. However, when the BEAM FINDER switch is pressed in, the power from the unregulated +150-volt supply is interrupted and the collector voltage for Q884 and Q894 is supplied from +75 volts through CR884. Since the collectors are returned to a lower potential, the output voltage swing is reduced to limit the horizontal deflection within the graticule area.

Z AXIS AMPLIFIER

General

The Z Axis Amplifier circuit controls the CRT intensity level from several inputs. The effect of these input signals is to either increase or decrease the trace intensity, or to completely blank portions of the display. Fig. 3-15 shows a detailed block diagram of the Z Axis Amplifier circuit. A schematic of this circuit is shown on diagram 15 at the rear of this manual.

Input Amplifier

The input transistor, Q1014, in the Input Amplifier stage is a current-driven, low-input impedance amplifier. It provides termination for the input signals as well as isolation between the input signals and the following stages. The current signals from the various control sources are connected to the emitter of Q1014 and the sum or difference of the signals determines the collector conduction level. CR1015 and CR1016 in the collector provide limiting protection at minimum intensity. When the INTENSITY control is set fully counterclockwise (minimum), the collector current of Q1014 is reduced and its collector rises positive. CR1015 is reverse biased to block the control current at the base of Q1023, and CR1016 is forward biased to protect the circuit by clamping the collector of Q1014 about 0.5 volt more positive than the emitter level of Q1023. This limiting action also takes place when a blanking signal is applied. The clamping of CR1016 allows Q1014 to recover faster to produce a sharper display with sudden changes in blanking level. At normal intensity levels, CR1016 is reverse biased and the signal from Q1014 is coupled to emitter follower Q1023 through CR1015.

The input signals vary the current drive to the emitter of Q1014, which produces a collector level that determines the brilliance of the display. INTENSITY control R1005 sets the quiescent level at the emitter of Q1014. When R1005 is turned in the clockwise direction, more current

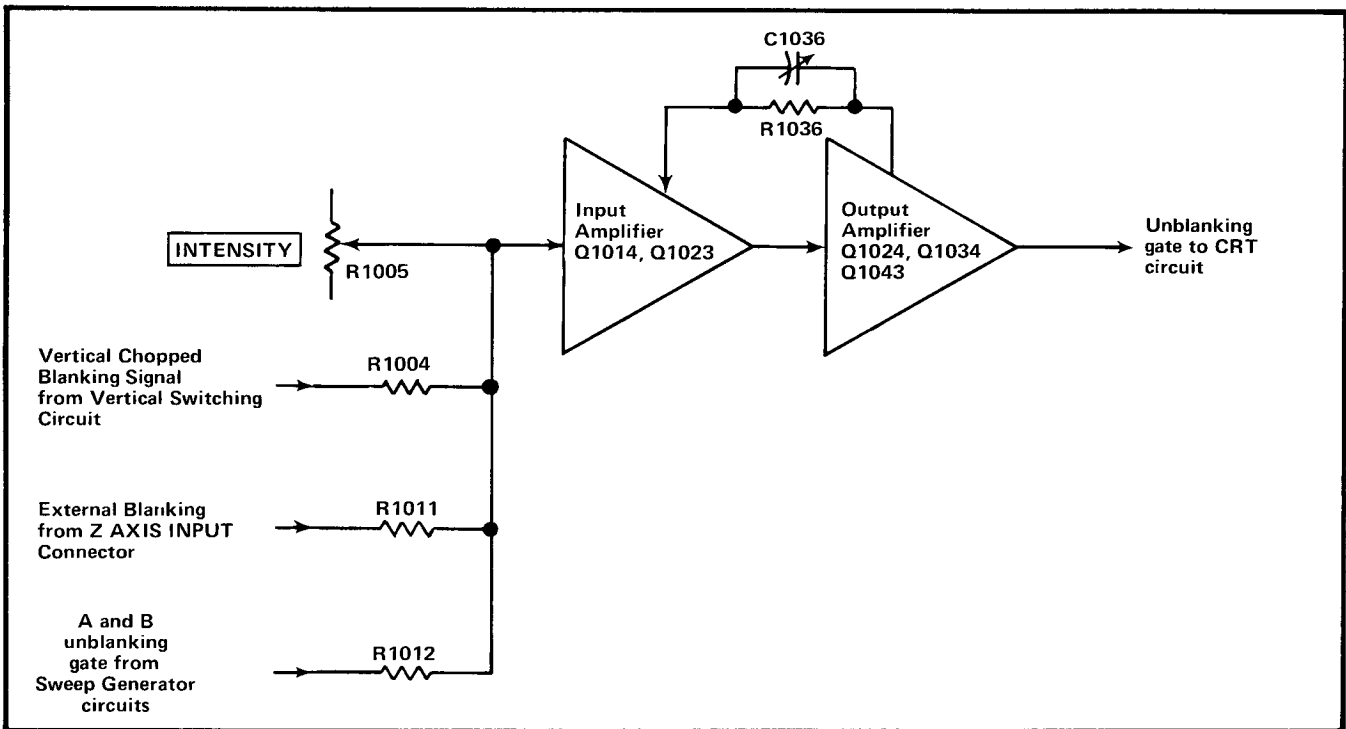


Fig. 3-15. Z Axis Amplifier detailed block diagram.

from the INTENSITY control is added to the emitter circuit of Q1014, which results in an increase in collector current to provide a brighter trace. However, the vertical chopped blanking, Z Axis Input, and sweep unblanking signals (A, B, and mixed) determine whether the trace is visible. The vertical chopped blanking signal blanks the trace during dual-trace switching. This signal decreases the current through Q1014 during the trace switching time to blank the CRT display. The external blanking input allows an external signal connected to the Z AXIS INPUT connector to change the trace intensity. A positive-going signal connected to the Z AXIS INPUT connector decreases trace intensity and a negative-going signal increases trace intensity. The A, B, and mixed unblanking gate signals from the A and B Sweep Generator circuits blank the CRT during sweep retrace and recovery time so there is no display on the screen. When the Sweep Generator circuits are reset and recovered (see A and B Sweep Generator discussion for more information), the next trigger initiates the sweep and an unblanking gate signal is generated by the A or B Sweep Generator circuit that goes negative to allow the emitter current of Q1014 to reach the level established by the INTENSITY control and the other blanking inputs.

Output Amplifier

The resultant signal produced from the various inputs by the Input Amplifier stage is connected to the base of Q1024 through C1029 and to the base of Q1034 through R1024. These transistors are connected as a collector-

coupled complementary amplifier. This configuration provides a linear, fast output signal with minimum quiescent power.

The overall Z-Axis Amplifier circuit is a shunt-feedback operational amplifier with feedback from the Output Amplifier stage to the Input Amplifier stage through C1036-C1037-R1036. The output voltage is determined by the input current times the feedback resistor and is shown by the formula: $E_{out} = i_{in} \times R_{fb}$ where R_{fb} is R1036. The unblanking input current change is approximately two milliamperes. Therefore, the output voltage change is about 60 volts ($2 \text{ mA} \times 30.1 \text{ k}\Omega$). C1036 adjusts the feedback circuit for optimum high-frequency response.

Zener diode VR1043 connected between +75 volts and +150 volts through CR1044, R1044, and R1043 produces a +90-volt level at the cathode of VR1043. This voltage establishes the correct collector level for Q1043. CR1045 connected from base to emitter of Q1043 improves the response of Q1043 to negative-going signals. When the base of Q1043 is driven negative to cutoff, CR1045 is forward biased and conducts the negative-going portion of the unblanking signal. This provides a fast falling edge on the unblanking gate to quickly turn the display off. The output unblanking gate at the emitter of Q1043 is connected to the CRT circuit through R1046.

CRT CIRCUIT

General

The CRT Circuit provides the high voltage and control circuits necessary for operation of the cathode-ray tube (CRT). Fig. 3-16 shows a detailed block diagram of the CRT Circuit. A schematic of this circuit is shown on diagram 16 at the rear of this manual.

High-Voltage Oscillator

Q930 and associated circuitry comprise the high-voltage oscillator to produce the drive for high-voltage transformer T930. When the instrument is turned on, the current through R925 charges C913 positive and Q930 is forward biased. The collector current of Q930 increases and a voltage is developed across the collector winding of T930. This produces a corresponding voltage increase in the feedback winding of T930 which is connected to the base of Q930, and it conducts even harder. While Q930 is on, its base current exceeds the current through R925 and C913 charges negatively. Eventually the rate of collector current increase in Q930 becomes less than that required to maintain the voltage across the collector winding, and the output voltage drops. This turns off Q930 by way of the feedback voltage to the base. The voltage waveform at the collector of Q930 is a sine wave at the resonant frequency of T930. Q930 remains off until a little less than one cycle

later when C913 discharges sufficiently to raise the voltage at the base of Q930 positive enough to bias Q930 into conduction again. The cycle repeats at a frequency of 40 to 50 kilohertz. The amplitude of sustained oscillation depends upon the average current delivered to the base of Q930.

Fuse F937 protects the +12-volt Supply if the High-voltage Oscillator stage is shorted. C937 and L937 prevent the current changes at the collector of Q390 from affecting the +12-volt regulator circuit.

High-Voltage Regulator

Feedback from the secondary of T930 is connected to the base of Q914 through the voltage divider network R903-R910. This sample of the output voltage is compared to the -12-volt level at the emitter of Q914. Any change in the level at the base of Q914 produces an error signal at the collector of Q914 which is amplified by Q914 and Q913 and applied to the base of Q923. Amplitude of the oscillations at the collector of Q930 is determined by the average DC level at the emitter of Q923.

Regulation occurs as follows: If the output voltage at the -1960 V test point starts to go positive (less negative),

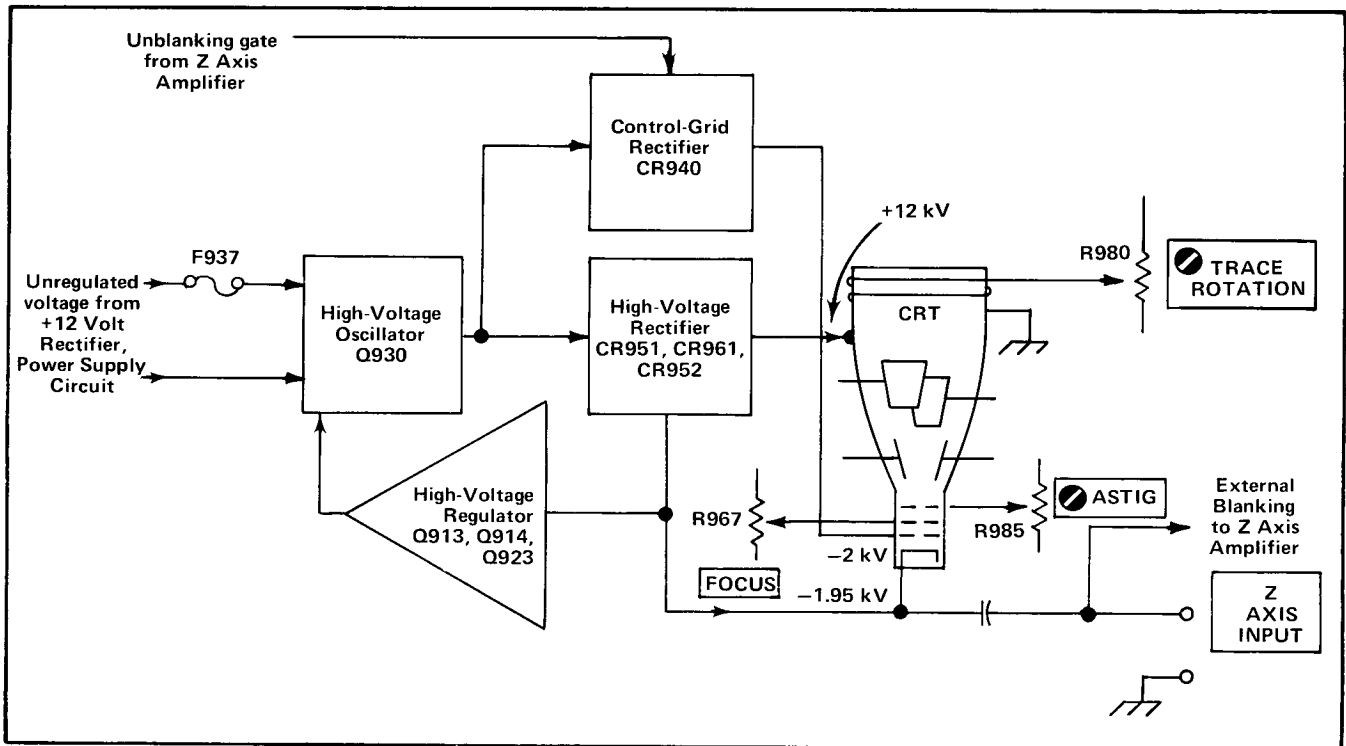


Fig. 3-16. CRT Circuit detailed block diagram.

Circuit Description—453A/R453A

a sample of this positive-going voltage is applied to the base of Q914. Q914 is forward biased and it, in turn, forward biases Q913 and Q923. This results in a greater bias current to the base of Q930 through the feedback winding of T930. Now, Q930 is biased closer to its conduction level so it comes into conduction sooner to produce a larger induced voltage in the secondary of T930. This increased voltage appears as a more negative voltage at the -1960 V test point to correct the original positive-going change. By sampling the output from the cathode supply in this manner, the total output of the high-voltage supply is held constant.

Output voltage level of the high-voltage supply is controlled by High Voltage adjustment R900 in the base circuit of Q914. This adjustment sets the conduction of Q914 to a level which establishes a -1960-volt operating potential at the CRT cathode.

High Voltage Rectifiers and Output

High-voltage transformer T930 has three output windings. One winding provides filament voltage for the cathode-ray tube. The filament voltage can be supplied from the high-voltage supply since the cathode-ray tube has a very low filament current drain. The cathode and filament are connected together through R975 to elevate the filament and prevent cathode-to-filament breakdown. Two high-voltage windings provide the negative and positive accelerating voltage and the CRT grid bias voltage. All of these outputs are regulated by the High-Voltage Regulator stage in the primary of T930 to hold the output voltage constant.

Positive accelerating potential is supplied by voltage tripler CR953, CR955, and CR957. Regulated voltage output is about $+12$ kilovolts. Ground return for this supply is through the resistive helix inside the cathode-ray tube to ground through VR963.

The negative accelerating potential for the CRT cathode is supplied by half-wave rectifier CR952. Voltage output is about -1.96 kilovolts. A sample of this output voltage is connected to the High-Voltage Regulator stage to provide a regulated high-voltage output.

Half-wave rectifier CR940 provides a negative voltage for the control grid of the CRT. Output level of this supply is set by CRT Grid Bias adjustment R940. Neon bulbs DS973, DS974, and DS975 provide protection if the voltage difference between the control grid and cathode exceeds about 165 volts. The unblanking gate from the Z Axis Amplifier is applied to the positive side of this circuit to produce a change in output voltage to control CRT intensity, unblanking, dual-trace blanking, and intensity modulation.

CRT Control Circuits

Focus of the CRT display is controlled by FOCUS control R967. ASTIG adjustment R985 which is used in conjunction with the FOCUS control to provide a well-defined display, varies the positive level on the astigmatism grid. Geometry adjustment R982 varies the positive level on the horizontal deflection plate shields to control the overall geometry of the display.

Two adjustments control the trace alignment by varying the magnetic field around the CRT. Y Axis Align adjustment R989 controls the current through L989 which affects the CRT beam after vertical deflection but before horizontal deflection. Therefore, it affects only the vertical (Y) components of the display. TRACE ROTATION adjustment R980 controls the current through L980 and affects both vertical and horizontal rotation of the beam.

External Z Axis Input

Signals applied to the Z AXIS INPUT connector (see Z Axis Amplifier schematic) are applied to the CRT cathode through C979-C976-R976. DC and low frequency Z-axis signals are blocked from the CRT Circuit by C979. However, they are connected to the Z Axis Amplifier circuit to produce an increase or decrease in intensity, depending upon polarity. C976 and C979 couple high-frequency signals directly to the CRT cathode to produce the same resultant display as the Z Axis Amplifier circuit produces for low-frequency signals. This configuration operates as a crossover network to provide nearly constant intensity modulation from DC to 50 megahertz.

LOW-VOLTAGE POWER SUPPLY

General

The Low-Voltage Power Supply circuit provides the operating power for this instrument from three regulated supplies and one unregulated supply. Electronic regulation is used to provide stable, low-ripple output voltages. Each regulated supply contains a short-protection circuit to prevent instrument damage if a supply is inadvertently shorted to ground. The Power Input stage includes the Line Voltage Selector assembly. This assembly allows selection of the nominal operating voltage and regulating range for the instrument. Fig. 3-17 shows a detailed block diagram of the Power Supply circuit. A schematic of this circuit is shown on diagram 17 at the rear of this manual.

Power Input

Power is applied to the primary of transformer T1101 through the 115-volt line fuse F1101, POWER switch S1101, thermal cutout S1104, Voltage Selector switch S1102, and Range Selector switch S1103. The Voltage

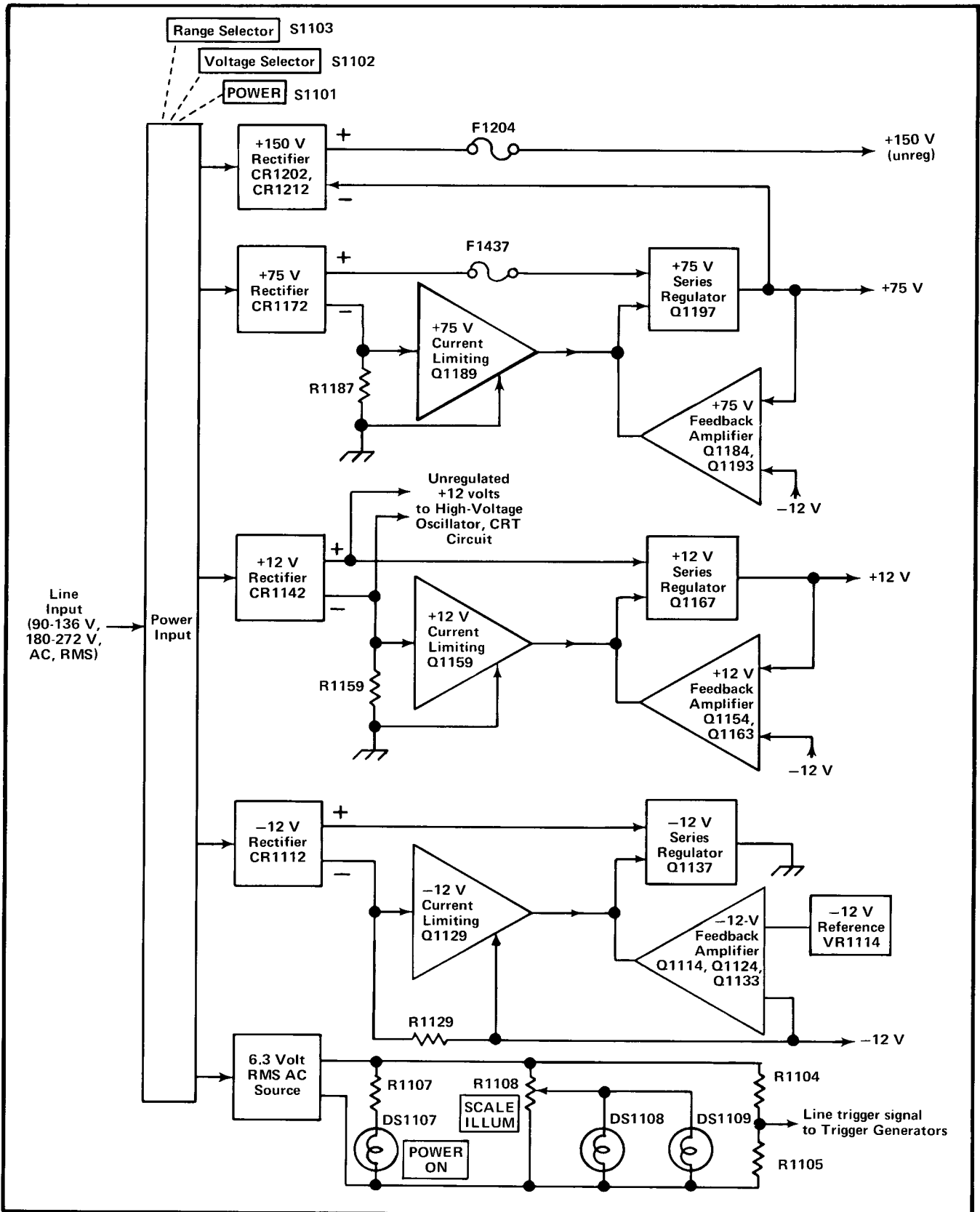


Fig. 3-17. Power Supply detailed block diagram.

Circuit Description—453A/R453A

Selector switch S1102 connects the split primaries of T1101 in parallel for 115-volt nominal operation, or in series for 230-volt nominal operation. A second line fuse, F1102, is connected into this circuit when the Voltage Selector switch is set to the 230 V position to provide the correct protection for 230-volt operation (F1102 current rating is one-half of F1101).

Range Selector switch S1103 allows the instrument to regulate correctly on higher or lower than normal line voltages. Each half of the primary has taps above and below the nominal voltage point (115 or 230 volts). As Range Selector switch S1103 is switched from LO to M to HI, more turns are effectively added to the primary winding and the turns ratio is decreased. This configuration compensates for higher or lower than normal line voltage to extend the regulating range of the Low-Voltage Power Supply.

Thermal cutout S1104 provides thermal protection for this instrument. If the internal temperature of the instrument exceeds a safe operating level, S1104 opens to interrupt the applied power. When the temperature returns to a safe level, S1104 automatically closes to re-apply the power.

–12-Volt Supply

The following discussion includes the description of the –12 V Rectifier, –12 V Series Regulator, –12 V Feedback Amplifier, –12 V Reference, and –12 V Current Limiting stages. Since these stages are closely related in the production of the –12-volt regulated output voltage, their operation is most easily understood when discussed as a unit.

The –12 V Rectifier assembly CR1112 rectifies the output at the secondary of T1101 to provide the unregulated voltage source for this supply. CR1112 is connected as a bridge rectifier and its output voltage is filtered by C1112 before it is applied to the –12 V Series Regulator Q1137. Transistors Q1114, Q1124, and Q1133 operate as a feedback-stabilized regulator circuit to maintain a constant –12-volt output level. Q1114 and Q1124 are connected as a differential amplifier to compare the feedback voltage at the base of Q1124 against the reference voltage at the base of Q1114. The error output at the collector of Q1114 reflects the difference, if any, between these two inputs. The change in error-output level at the collector of Q1124 is always in the same direction as the change in the feedback input at the base of Q1124 (in phase).

Zener diode VR1114 sets a reference level of about –9 volts at the base of Q1114. A sample of the output voltage from this supply is connected to the base of Q1124 through

divider R1121-R1122-R1123. R1122 in this divider is adjustable to set the output level of this supply. Regulation occurs as follows: If the output level of this supply decreases (less negative) due to an increase in load, or a decrease in input voltage (as a result of line voltage changes or ripple), the voltage across divider R1121-R1122-R1123 decreases also. This results in a more positive feedback level at the base of Q1124 than established by the –12 V Reference stage at the base of Q1114. Since the transistor with the more positive base controls the conduction of the differential amplifier, the output current at the collector of Q1114 decreases. This decrease in output from Q1114 allows more current to flow through Q1133 to result in increased conduction of –12 V Series Regulator Q1137. The load current increases and the output voltage of this supply also increases (more negative). As a result, the feedback voltage to the base of Q1124 returns to the same level as the base of Q1114. Similarly, if the output level of this supply increases (more negative), the output current of Q1114 increases. The feedback through Q1133 reduces the conduction of the –12 V Series Regulator to decrease the output voltage of this supply.

The –12 Volts adjustment R1122 determines the divider ratio to the base of Q1124, and thereby determines the feedback voltage. This adjustment sets the output level of the supply in the following manner: If R1122 is adjusted so the voltage at its variable arm goes less negative (closer to ground), this appears as an error signal at the base of Q1124. In the same manner as described previously, this positive-going change at the feedback input of the differential amplifier increases the conduction of the –12 V Series Regulator to produce more current through the load, and thereby increase the output voltage of this supply. This places more voltage across divider R1121-R1122-R1123, and the divider action returns the base of Q1124 to about –9 volts. Notice that the feedback action of this supply forces a change in the output level which always returns the base of Q1124 to the same level as the base of Q1114. In this manner, the output level of the –12-Volt Supply can be set exactly to –12 volts by correct adjustment of R1122.

The –12 V Current Limiting stage Q1129 protects the –12-Volt Supply if excess current is demanded from this supply. All output current from the –12-Volt Supply must flow through R1129. Transistor Q1129 senses the voltage drop across R1129. Under normal operating conditions, there is about 0.3-volt drop across R1129, which is not sufficient to forward bias Q1129. However, when excess current is demanded from the –12 V Series Regulator due to a short circuit or similar malfunction at the output of this supply, the voltage drop across R1129 increases until it is sufficient to forward bias Q1129. The collector current of Q1129 results in a reduction of current through Q1133 to decrease the conduction of Q1137 and limit the output current.

+12-Volt Supply

The unregulated voltage applied to the +12-Volt Supply is also connected to the High-Voltage Oscillator stage in the CRT circuit.

Basic operation of all stages in the +12-Volt Supply is similar to the -12-Volt Supply. However, the +12 V Feedback Amplifier provides inversion in the feedback path. The reference level for this supply is established by the ground connection at the emitter of Q1154. Feedback voltage to the base of Q1154 is provided by divider R1151-R1152-R1153 between the output of this supply and regulated -12 volts. The -12 volts is held stable by the -12-Volt Supply as discussed previously. Therefore, any change at the output of the +12-Volt Supply appears at the base of Q1154 as an error signal. The output voltage is regulated in the manner described previously for the -12-Volt Supply. Diode CR1152 provides thermal compensation for the +12 V Feedback Amplifier. CR1164 protects Q1154 from damage if the output of this supply is shorted to a more positive supply.

+75-Volt Supply

Operation of the +75-Volt Supply is the same as described for the other supplies. The unregulated output of the +150-Volt Supply is connected to the +75 V Feedback Amplifier to provide sufficient collector supply for stable operation. The unregulated +150 volts connected to zener diode VR1209 through R1209 establishes a voltage level at the cathode of VR1209 of about +108 volts. The drop across R1186 sets the correct base level for Q1193 and the drop across VR1185-R1185 sets the correct collector level for Q1184. Diode CR1182 provides thermal compensation for the +75 V Feedback Amplifier.

Two means of overload protection are provided for this supply. The +75 V Current Limiting stage Q1189 operates in a manner similar to that described previously to control the conduction of the +75 V Series Regulator through CR1188 and Q1193. In addition, F1437 provides overload protection for this supply. Diode CR1198 protects the +75-Volt Supply from damage if it is shorted to the -12-Volt Supply.

+150-Volt Unregulated Supply

Rectifiers CR1202 and CR1212 provide the rectified voltage for the +150-Volt Supply. However, this secondary winding of T1101 does not supply the full potential necessary to obtain the +150-volt output level. To provide the required output level, the negative side of this supply is connected to the output of the +75-Volt Supply so the two supplies are effectively connected in series between ground and the +150-volt output. The output from this secondary winding of T1101 also provides the operating potential for

the fan. The full-wave output of the +150 V Rectifier is filtered by C1202-C1204-R1204 to provide an output level of about +150 volts. Fuse F1204 protects this supply if the output is shorted.

6.3-Volt RMS AC Source

The 6.3-volt RMS secondary winding of T1101 provides power for the POWER ON light, DS1107, and the scale illumination lights, DS1108 and DS1109. The current through the scale illumination lights is controlled by the SCALE ILLUM control, R1108, to change the illumination of the graticule lines. Divider R1104-R1105 provides a sampling of the line voltage to the A and B Trigger Generator circuits for internal triggering at the line frequency. C1105 reduces noise on the line frequency signal.

VOLTAGE DISTRIBUTION

Diagram 17 also shows the distribution of the output voltages from the Power Supply circuit to the circuit boards in this instrument. The decoupling networks which provide decoupled operating voltages are shown on this Diagram and are not repeated on the individual circuit diagrams.

CALIBRATOR

General

The Calibrator circuit produces a square-wave output with accurate amplitude and frequency. This output is available as a square-wave voltage at the 1 kHz CAL connector or as a square-wave current through the side-panel PROBE LOOP. Fig. 3-18 shows a detailed block diagram of the Calibrator circuit. A schematic of this circuit is shown on diagram 18 at the rear of this manual.

Oscillator

Q1255 and its associated circuitry comprise a tuned-collector oscillator. Frequency of oscillation is determined by the LC circuit made up of the primary of variable transformer T1255 in parallel with C1255. The accuracy and stability required to provide an accurate time and frequency reference is obtained by using a capacitor and transformer which have equal but opposite temperature coefficients.

The oscillations of the LC circuit, T1255-C1255, are sustained by the feedback winding of T1255 connected to the base of Q1255. C1266 connects a sample of the output of the LC circuit to the base of Q1265. The regenerative feedback from the emitter of Q1265 to the emitter of Q1255 produces fast changeover between Q1255 and Q1265 to provide a fast risetime on the output square wave. Frequency of the output square wave can be adjusted by

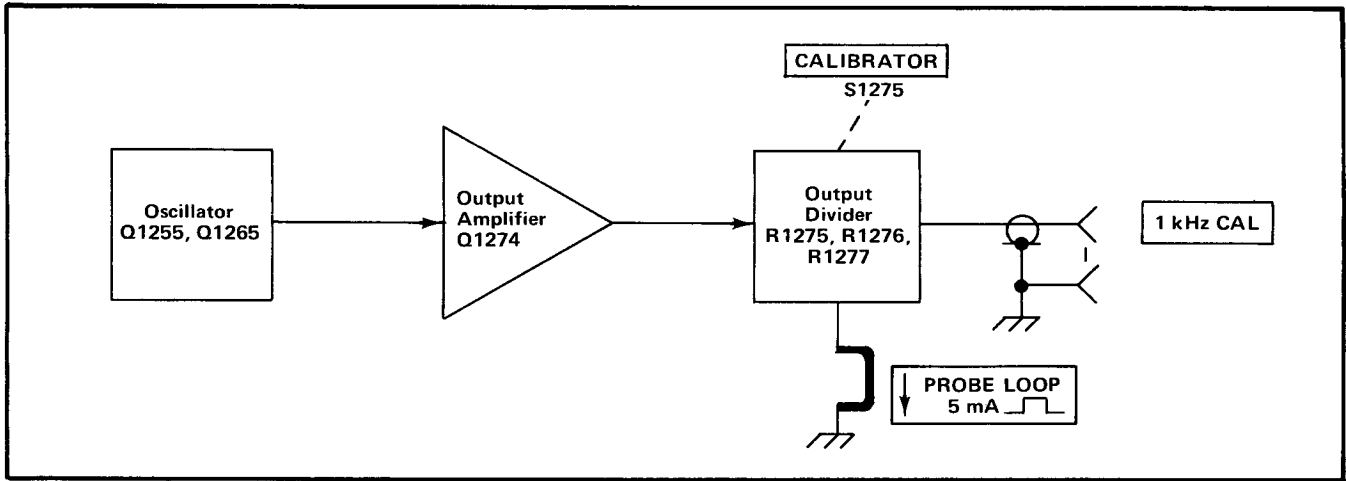


Fig. 3-18. Calibrator detailed block diagram.

varying the coupling to the feedback winding of T1255. The square-wave signal at the collector of Q1265 is connected to the Output Amplifier.

Output Amplifier

The output signal from the oscillator stage saturates Q1274 to produce the accurate square wave at the output. When the base of Q1274 goes positive, Q1274 is cut off and the output signal drops negative to ground. When its base goes negative, Q1274 is driven into saturation and the output signal rises positive to about +12 volts. The output of the +12-Volt Supply is adjusted for an accurate one-volt output signal at the 1 kHz CAL connector when the CALIBRATOR switch is set to 1 V.

Output Divider

Output Divider R1275-R1276-R1277 provides two output voltages from the Calibrator circuit. In the 1 V CALIBRATOR switch position, voltage is obtained from the collector of Q1274 through R1274. In the .1 V CALIBRATOR switch position, the output is obtained at the junction of voltage divider R1275 and R1276-R1277 to provide one-tenth of the previous output voltage.

Collector current of Q1274 flows through the PROBE LOOP on the side panel. Output current is a five-milliampere square wave.

SECTION 4

MAINTENANCE

Change information, if any, affecting this section will be found at the rear of this manual.

Introduction

This section of the manual contains maintenance information for use in preventive maintenance, corrective maintenance, or troubleshooting of the 453A.

Cover Removal

The top and bottom covers of the instrument are held in place by thumb screws located on each side of the instrument. To remove the covers, loosen the thumb screws and slide the covers off the instrument. The covers protect the instrument from dust in the interior. The covers also direct the flow of cooling air and reduce the EMI radiation from the instrument.

PREVENTIVE MAINTENANCE

General

Preventive maintenance consists of cleaning, visual inspection, lubrication, etc. Preventive maintenance, performed on a regular basis may prevent instrument breakdown and will improve the reliability of this instrument. The severity of the environment to which the 453A is subjected determines the frequency of maintenance. A convenient time to perform preventive maintenance is preceding recalibration of the instrument.

Cleaning

General. The 453A should be cleaned as often as operating conditions require. Accumulation of dirt in the instrument can cause over-heating and component breakdown. Dirt on components acts as an insulating blanket and prevents efficient heat dissipation. It also provides an electrical conduction path.



Avoid the use of chemical cleaning agents which might damage the plastics used in this instrument. Avoid chemicals which contain benzene, toluene, xylene, acetone, or similar solvents.

The top and bottom covers provide protection against dust in the interior of the instrument. Operation without

the covers in place necessitates more frequent cleaning. The front cover provides dust protection for the front panel and the CRT face. The front cover should be installed for storage or transportation.

Air Filter. The air filter should be visually checked every few weeks and cleaned or replaced if dirty. More frequent inspections are required under severe operating conditions. The following procedure is suggested for cleaning the filter. If the filter is to be replaced, order new air filters from your local Tektronix Field Office or representative; order by Tektronix Part No. 378-0033-00.

1. Remove the filter by pulling it out of the retaining frame on the rear panel. Be careful not to drop any of the accumulated dirt into the instrument.
2. Flush the loose dirt from the filter with a stream of hot water.
3. Place the filter in a solution of mild detergent and hot water and let it soak for several minutes.
4. Squeeze the filter to wash out any dirt which remains.
5. Rinse the filter in clear water and allow it to dry.
6. Coat the dry filter with an air-filter adhesive (available from air conditioner suppliers, or order Tektronix Part No. 006-0580-00).
7. Let the adhesive dry thoroughly.
8. Re-install the filter in the retaining frame.

Exterior. Loose dust accumulated on the outside of the 453A can be removed with a soft cloth or small brush. The brush is particularly useful for dislodging dirt on and around the front-panel controls. Dirt which remains can be removed with a soft cloth dampened in a mild detergent and water solution. Abrasive cleaners should not be used.

Maintenance—453A/R453A

CRT. Clean the plastic light filter, faceplate protector, and the CRT face with a soft, lint-free cloth dampened with denatured alcohol. The optional CRT mesh filter can be cleaned in the following manner.

1. Hold the filter in a vertical position and brush lightly with a soft No.7 water-color brush to remove light coatings of dust or lint.

2. Greasy residues or dried-on dirt can be removed with a solution of warm water and a neutral-pH liquid detergent. Use the brush to lightly scrub the filter.

3. Rinse the filter thoroughly in clean water and allow to air dry.

4. If any lint or dirt remains, use clean low-pressure air to remove. Do not use tweezers, or other hard cleaning tools on the filter, as the special finish may be damaged.

5. When not in use, store the mesh filter in a lint-free, dust-proof container such as a plastic bag.

Interior. Dust in the interior of the instrument should be removed occasionally due to its electrical conductivity under high-humidity conditions. The best way to clean the interior is to blow off the accumulated dust with dry, low-velocity air. Remove any dirt which remains with a soft brush or a cloth dampened with a mild detergent and water solution. A cotton-tipped applicator is useful for cleaning in narrow spaces or for cleaning ceramic terminal strips and circuit boards.

The high-voltage circuits, particularly parts located in the high-voltage compartment and the area surrounding the post-deflection anode connector, should receive special attention. Excessive dirt in these areas may cause high-voltage arcing and result in improper instrument operation.

Lubrication

General. The reliability of potentiometers, rotary switches and other moving parts can be maintained if they are kept properly lubricated. Use a cleaning-type lubricant (e.g., Tektronix Part No. 006-0218-00) on switch contacts. Lubricate switch detents with a heavier grease (e.g., Tektronix Part No. 006-0219-00). Potentiometers which are not permanently sealed should be lubricated with a lubricant which does not affect electrical characteristics (e.g., Tektronix Part No. 006-0220-00). The pot lubricant can also be used on shaft bushings. Do not over-lubricate. A lubrication kit containing the necessary lubricants and instructions is available from Tektronix, Inc. Order Tektronix Part No. 003-0342-01.

Fan. The fan-motor bearings are sealed and do not require lubrication.

Visual Inspection

The 453A should be inspected occasionally for such defects as broken connections, broken or damaged ceramic strips, improperly seated transistors, damaged circuit boards, and heat-damaged parts.

The corrective procedure for most visible defects is obvious; however, particular care must be taken if heat-damaged components are found. Over-heating usually indicates other trouble in the instrument; therefore, it is important that the cause of over-heating be corrected to prevent recurrence of the damage.

Transistor Checks

Periodic checks of the transistors in the 453A are not recommended. The best check of transistor performance is actual operation in the instrument. More details on checking transistor operation are given under Troubleshooting.

Recalibration

To assure accurate measurements, check the calibration of this instrument after each 1000 hours of operation or every six months if used infrequently. In addition, replacement of components may necessitate recalibration of the affected circuits. Complete calibration instructions are given in the Calibration section.

The calibration procedure can also be helpful in localizing certain troubles in the instrument. In some cases, minor troubles may be revealed and/or corrected by recalibration.

TROUBLESHOOTING

Introduction

The following information is provided to facilitate troubleshooting of the 453A. Information contained in other sections of this manual should be used along with the following information to aid in locating the defective component. An understanding of the circuit operation is very helpful in locating troubles. See the Circuit Description section for complete information.

Troubleshooting Aids

Diagrams. Complete circuit diagrams are given on fold-out pages in the Diagrams section. The component number

and electrical value of each component in this instrument are shown on the diagrams (see first page of the Diagrams section for definition of the reference designators used to identify components in this instrument). Each main circuit is assigned a series of component numbers. Table 4-1 lists the main circuits in the 453A and the series of component numbers assigned to each. Important voltages and waveforms are also shown on the diagrams. The portions of the circuit mounted on circuit boards are enclosed with blue lines.

TABLE 4-1
Component Numbers

Component Numbers on Diagrams	Diagram Number	Circuit
1-99	1	Channel 1 Vertical Preamp
100-199	3	Channel 2 Vertical Preamp
200-299	5	Vertical Switching
300-399	6	Vertical Output Amplifier
400-429	7	Trigger Preamp
430-499	8	A Trigger Generator
500-599	9	A Sweep Generator
600-699	10	B Trigger Generator
700-799	11	B Sweep Generator
800-899	13	Horizontal Amplifier
900-999	16	CRT Circuit
1000-1099	15	Z Axis Amplifier
1100-1199	17	Power Supply and Distribution
1250-1299	18	Calibrator

Switch Wafer Identification. Switch wafers shown on the diagrams are coded to indicate the position of the wafer in the complete switch assembly. The numbered portion of the code refers to the wafer number counting from the front, or mounting end of the switch, toward the rear. The letters F and R indicate whether the front or rear of the wafer performs the particular switching function. For example, a wafer designated 2R indicates that the rear of the second wafer from the front is used for this particular switching function.

Circuit Boards. Fig. 4-4 shows the location of the circuit boards within this instrument along with the assembly numbers. The assembly numbers are also used on the diagrams and in the parts list to aid in locating the boards. Pictures of the circuit boards are shown in Figs. 8-1 through 8-14. These pictures are located in the Diagrams section, on the back of the page opposite the circuit diagram, to aid the cross-referencing between the diagrams and the circuit-board pictures. Each electrical component on the boards is identified by its circuit number as well as the intercon-

necting wires and/or connectors. The circuit boards are also outlined on the diagrams with a blue line to show which portions of the circuit are located on a circuit board.

Wiring Color-Code. All insulated wire and cable used in the 453A is color-coded to facilitate circuit tracing. Signal carrying leads are identified with one or two colored stripes. Voltage supply leads are identified with three stripes to indicate the approximate voltage using the EIA resistor color code. A white background color indicates a positive voltage and a tan background indicates a negative voltage. The widest color stripe identifies the first color of the code. Table 4-2 gives the wiring color code for the power-supply voltages used in the 453A.

TABLE 4-2
Power Supply Wiring Color Code

Supply	Back-ground Color	First Stripe	Second Stripe	Third Stripe
-12 volt	Tan	Brown	Red	Black
+12 volt	White	Brown	Red	Black
+75 volt	White	Violet	Green	Black
+150 volt	White	Brown	Green	Brown

Resistor Color-Code. In addition to the brown composition resistors, some metal-film resistors and some wire-wound resistors are used in the 453A. The resistance values of wire-wound resistors are printed on the body of the component. The resistance values of composition resistors and metal-film resistors are color-coded on the components with EIA color-code (some metal-film resistors may have the value printed on the body). The color-code is read starting with the stripe nearest the end of the resistor. Composition resistors have four stripes which consist of two significant figures, a multiplier, and a tolerance value (see Fig. 4-1). Metal-film resistors have five stripes consisting of three significant figures, a multiplier, and a tolerance value.

Capacitor Marking. The capacitance values of common disc capacitors and small electrolytics are marked in microfarads on the side of the component body. The white ceramic capacitors used in the 453A are color coded in picofarads using modified EIA code (see Fig. 4-1).

Diode Color Code. The cathode end of each glass-encased diode is indicated by a stripe, a series of stripes, or a dot. For most silicon or germanium diodes with a series of stripes, the color-code also identifies the Tektronix Part Number using the resistor color-code system (e.g., a diode color-coded pink-, or blue-brown-gray-green indicates Tektronix Part Number 152-0185-00). The cathode and anode

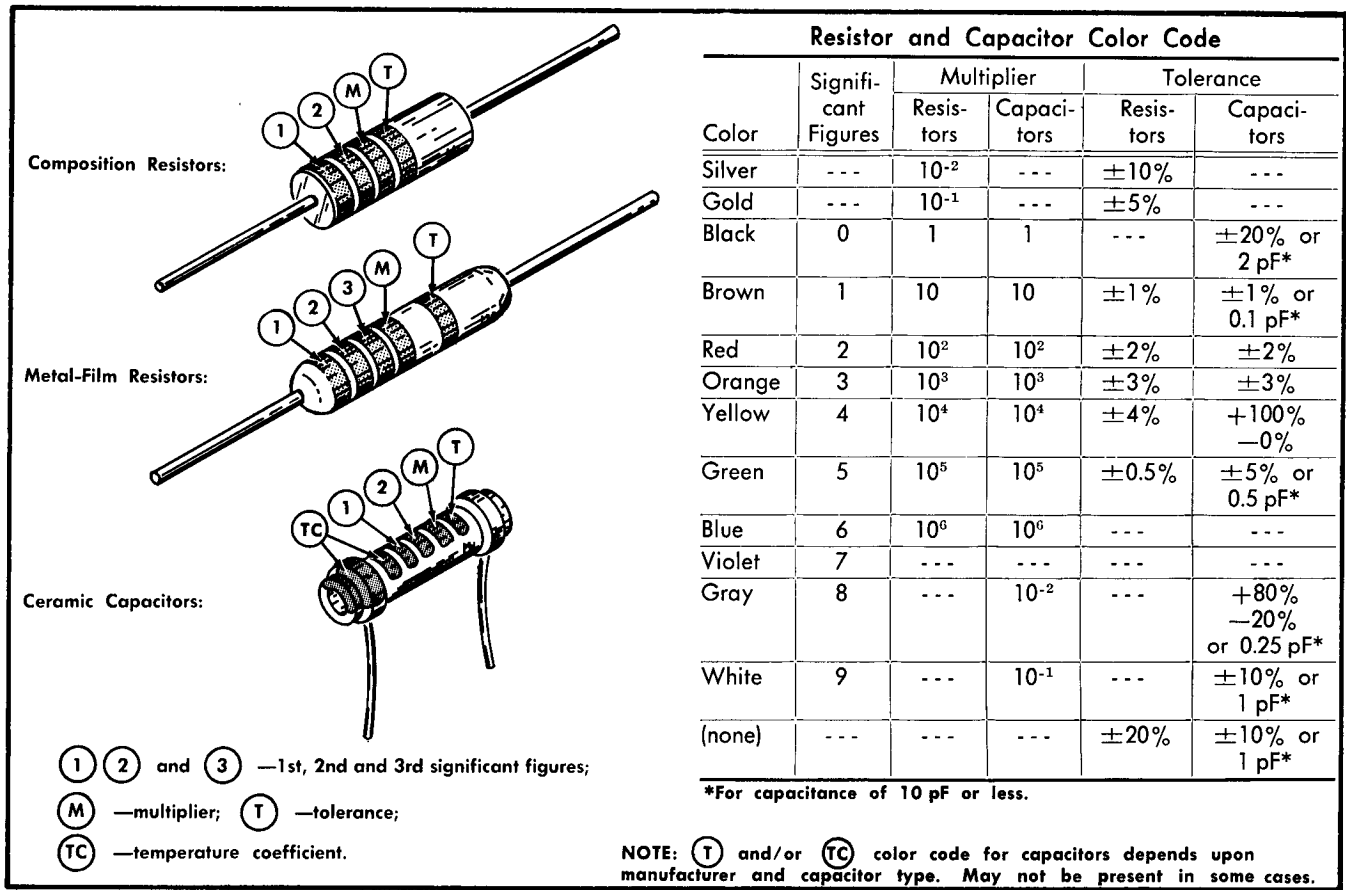


Fig. 4-1. Color code for resistors and ceramic capacitors.

end of metal-encased diodes can be identified by the diode symbol marked on the body.

Transistor Lead Configuration. Fig. 4-2 shows the lead configurations of the transistors used in this instrument. This view is as seen from the bottom of the transistors.

Troubleshooting Equipment

The following equipment is useful for troubleshooting the 453A.

1. Transistor Tester

Description: Tektronix Type 576 Transistor-Curve Tracer or equivalent.

Purpose: To test the semiconductors used in this instrument.

2. Multimeter

Description: VTVM, 10 megohm input impedance and 0 to 500 volts range; ohmmeter, 0 to 50 megohms. Accuracy,

within 3%. Test probes must be insulated to prevent accidental shorting.

Purpose: To check voltages and for general troubleshooting in this instrument.

NOTE

A 20,000 ohms/volt VOM can be used to check the voltages in this instrument if allowances are made for the circuit loading of the VOM at high-impedance points.

3. Test Oscilloscope

Description: DC to 20 megahertz frequency response. 5 millivolts to 10 volts/division deflection factor. Use a 10X probe.

Purpose: To check waveforms in this instrument.

Troubleshooting Techniques

This troubleshooting procedure is arranged in an order which checks the simple possibilities before proceeding

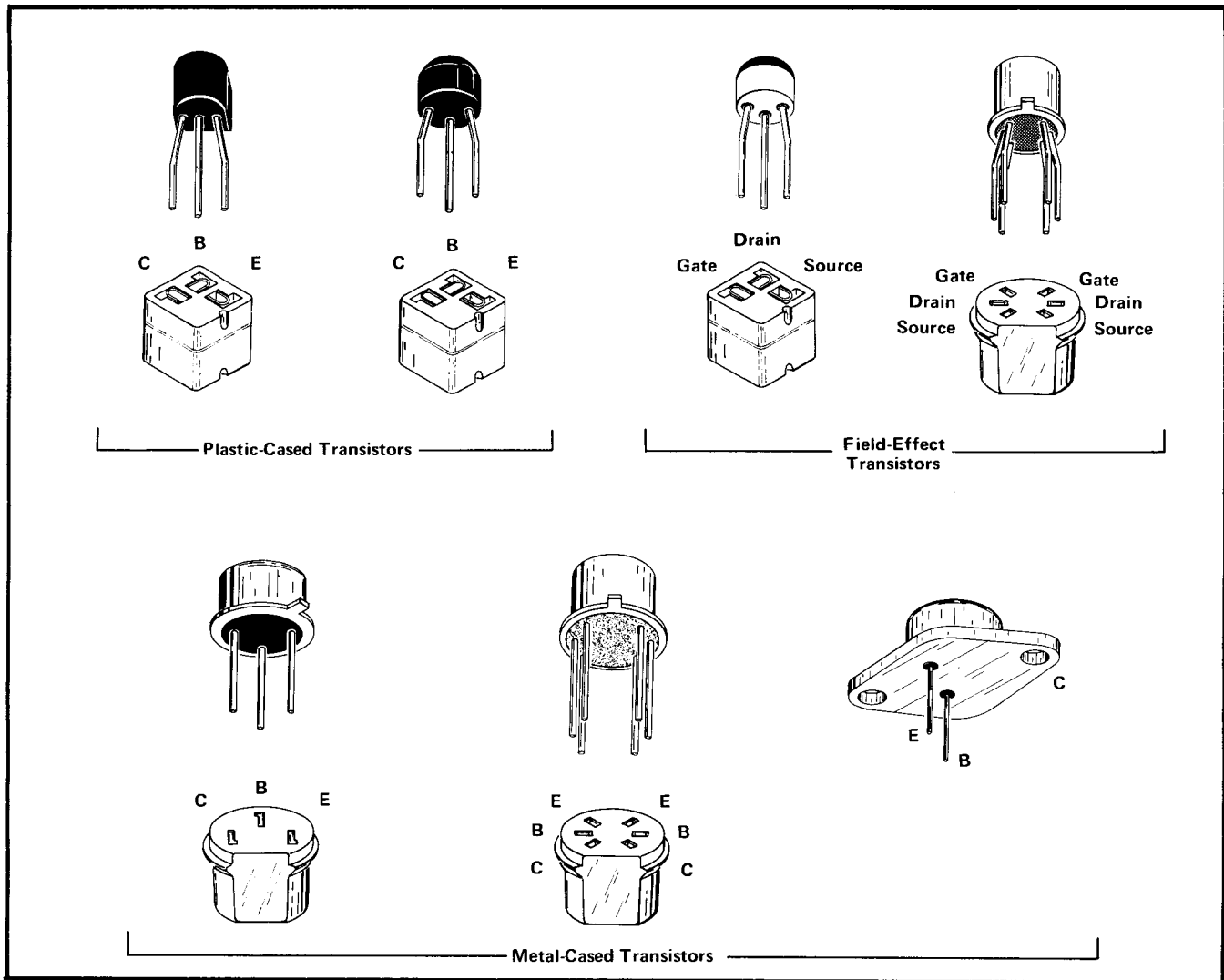


Fig. 4-2. Electrode configuration for semiconductors in this instrument.

with extensive troubleshooting. The first few checks assure proper connection, operation, and calibration. If the trouble is not located by these checks, the remaining steps aid in locating the defective component. When the defective component is located, it should be replaced following the replacement procedures given under Corrective Maintenance.

1. Check Control Settings. Incorrect control settings can indicate a trouble that does not exist. If there is any question about the correct function or operation of any control, see the Operating Instructions section of this manual.

2. Check Associated Equipment. Before proceeding with troubleshooting of the 453A, check that the equipment

used with this instrument is operating correctly. Check that the signal is properly connected and that the interconnecting cables are not defective. Also, check the power source.

3. Visual Check. Visually check the portion of the instrument in which the trouble is located. Many troubles can be located by visual indications such as unsoldered connections, broken wires, damaged circuit boards, damaged components, etc.

4. Check Instrument Calibration. Check the calibration of this instrument, or the affected circuit if the trouble exists in one circuit. The apparent trouble may only be a result of mis-adjustment or may be corrected by calibration. Complete calibration instructions are given in the Calibration section of this manual.

5. Isolate Trouble to a Circuit. To isolate trouble to a circuit, note the trouble symptom. The symptom often identifies the circuit in which the trouble is located. For example, poor focus indicates that the CRT (includes high voltage) circuit is probably at fault. When trouble symptoms appear in more than one circuit, check affected circuits by taking voltage and waveform readings. Also check for the correct output signals at the side-panel output connectors with a test oscilloscope. If the signal is correct, the circuit is working correctly up to that point. For example, correct amplitude and time of the A gate out waveform indicates that the A Trigger Generator and A Sweep Gate circuits are operating correctly.

Incorrect operation of all circuits often indicates trouble in the power supply. Check first for correct voltage of the individual supplies. However, a defective component elsewhere in the instrument can appear as a power-supply trouble and may also affect the operation of other circuits. Table 4-3 lists the tolerances of the power supplies in this instrument. If a power-supply voltage is within the listed tolerance, the supply can be assumed to be working correctly. If outside the tolerance, the supply may be mis-adjusted or operating incorrectly. Use the procedure given in the Calibration section to adjust the power supplies.

TABLE 4-3
Power Supply Tolerance

Power Supply	Tolerance
-12 volt	±0.12 volt
+12 volt	12.1 volts, ±0.12 volt ¹
+75 volt	±0.75 volt
-1960 volt	±58.5 volts

¹ Adjusted for correct output from the Calibrator circuit; see Calibration procedure.

Fig. 4-3 provides a guide to aid in locating a defective circuit. This chart may not include checks for all possible defects; use steps 6–8 in such cases. Start from the top of the chart and perform the given checks on the left side of the page until a step is found which is not correct. Further checks and/or the circuit in which the trouble is probably located are listed to the right of this step.

After the defective circuit has been located, proceed with steps 6 through 8 to locate the defective component(s).

6. Check Circuit Board Interconnections. After the trouble has been isolated to a particular circuit, check the pin connectors on the circuit board for correct connection.

The circuit board pictures in Section 8 show the correct connections for each board.

The pin connectors used in this instrument also provide a convenient means of circuit isolation. For example, a short in a power supply can be isolated to the power supply itself by disconnecting the pin connectors for that voltage at the remaining boards.

7. Check Voltages and Waveforms. Often the defective component can be located by checking for the correct voltage or waveform in the circuit. Typical voltages and waveforms are given on the diagrams.

NOTE

Voltages and waveforms given on the diagrams are not absolute and may vary slightly between instruments. To obtain operating conditions similar to those used to take these readings, see the first diagram page.

8. Check Individual Components. The following procedures describe methods of checking individual components in the 453A. Components which are soldered in place are best checked by disconnecting one end. This isolates the measurement from the effects of surrounding circuitry.

A. TRANSISTORS. The best check of transistor operation is actual performance under operating conditions. If a transistor is suspected of being defective, it can best be checked by substituting a new component or one which has been checked previously. However, be sure that circuit conditions are not such that a replacement transistor might also be damaged. If substitute transistors are not available, use a dynamic tester (such as Tektronix Type 576). Static-type testers are not recommended, since they do not check operation under simulated operating conditions.

B. DIODES. A diode can be checked for an open or shorted condition by measuring the resistance between terminals. With an ohmmeter scale having an internal source of between 800 millivolts and 3 volts, the resistance should be very high in one direction and very low when the leads are reversed.



Do not use an ohmmeter scale that has a high internal current. High currents may damage the diode. Do not measure tunnel diodes with an ohmmeter; use a dynamic tester (such as a Tektronix Type 576 Transistor-Curve Tracer).

C. **RESISTORS.** Check the resistors with an ohmmeter. Check the Electrical Parts List for the tolerance of the resistors used in this instrument. Resistors normally do not need to be replaced unless the measured value varies widely from the specified value.

D. **INDUCTORS.** Check for open inductors by checking continuity with an ohmmeter. Shorted or partially shorted inductors can usually be found by checking the waveform response when high-frequency signals are passed through the circuit. Partial shorting often reduces high-frequency response (roll-off).

E. **CAPACITORS.** A leaky or shorted capacitor can best be detected by checking resistance with an ohmmeter on the highest scale. Do not exceed the voltage rating of the capacitor. The resistance reading should be high after initial charge of the capacitor. An open capacitor can best be detected with a capacitance meter or by checking whether the capacitor passes AC signals.

9. **Repair and Readjust the Circuit.** If any defective parts are located, follow the replacement procedures given in this section. Be sure to check the performance of any circuit that has been repaired or that has had any electrical components replaced.

CORRECTIVE MAINTENANCE

General

Corrective maintenance consists of component replacement and instrument repair. Special techniques required to replace components in this instrument are given here.

Obtaining Replacement Parts

Standard Parts. All electrical and mechanical part replacements for the 453A can be obtained through your local Tektronix Field Office or representative. However, many of the standard electronic components can be obtained locally in less time than is required to order them from Tektronix, Inc. Before purchasing or ordering replacement parts, check the parts list for value, tolerance, rating, and description.

NOTE

When selecting replacement parts, it is important to remember that the physical size and shape of a component may affect its performance in the instrument, particularly at high frequencies. All replacement parts should be direct replacements unless it is known that a different component will not adversely affect instrument performance.

Special Parts. In addition to the standard electronic components, some special components are used in the 453A. These components are manufactured or selected by Tektronix, Inc. to meet specific performance requirements, or are manufactured for Tektronix, Inc. in accordance with our specifications. These special components are indicated in the Electrical Parts List by an asterisk preceding the part number. Most of the mechanical parts used in this instrument have been manufactured by Tektronix, Inc. Order all special parts directly from your local Tektronix Field Office or representative.

Ordering Parts. When ordering replacement parts from Tektronix, Inc., include the following information:

1. Instrument type.
2. Instrument serial number.
3. A description of the part (if electrical, include circuit number).
4. Tektronix Part Number.

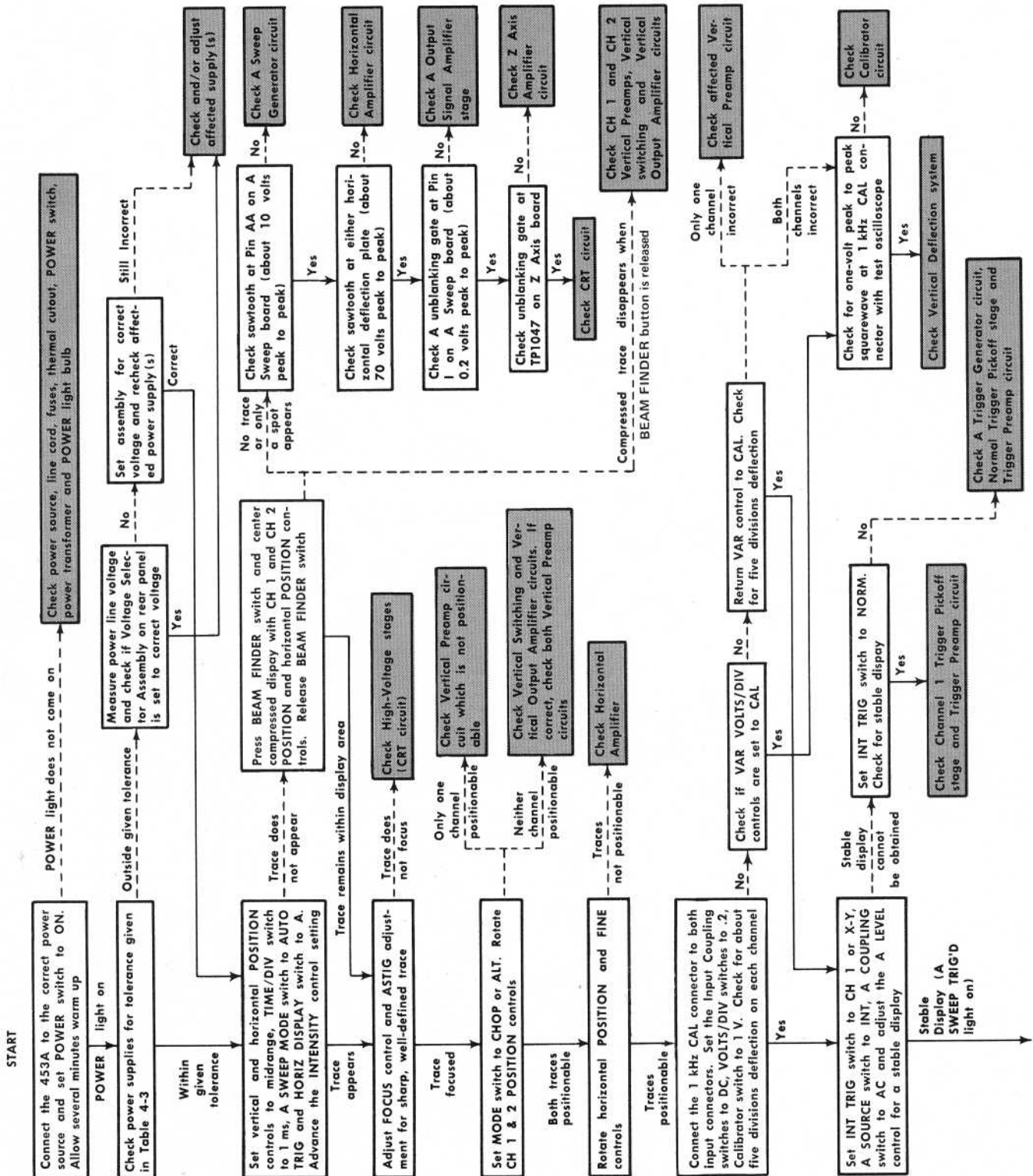
Soldering Techniques

WARNING

Disconnect the instrument from the power source before soldering.

The reliability and accuracy of this instrument can be maintained only if proper soldering techniques are used when repairing or replacing parts. General soldering techniques which apply to maintenance of any precision electronic equipment should be used when working on this instrument. Use only 60/40 rosin-core, electronic-grade solder. The choice of soldering iron is determined by the repair to be made. When soldering on circuit boards, use a 35- to 40-watt pencil-type soldering iron with an 1/8-inch wide, wedge-shaped tip. Keep the tip properly tinned for best heat transfer to the solder joint. A higher wattage soldering iron may separate the wiring from the base material. Avoid excessive heat; apply only enough heat to remove the component or to make a good solder joint. Also, apply only enough solder to make a firm solder joint; do not apply too much solder.

For metal terminals (e.g., switch terminals, potentiometers, etc.), a higher wattage-rating soldering iron may be required. Match the soldering iron to the work being done. For example, if the component is connected to the chassis or other large heat-radiating surface, it will require a 75-watt or larger soldering iron. The pencil-type soldering iron used on the circuit boards can be used for soldering to switch terminals, potentiometers, or metal terminals mounted in plastic holders.



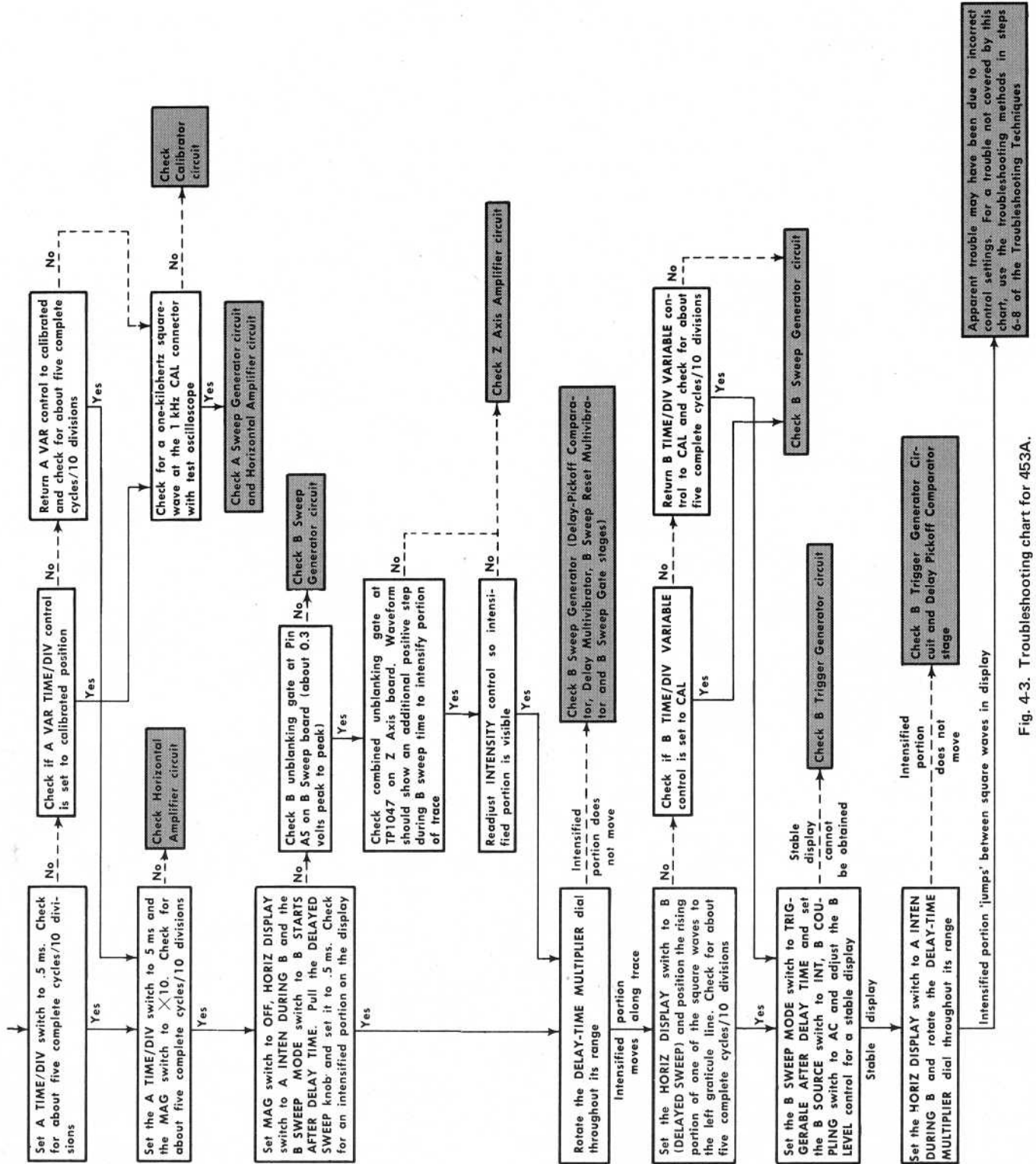


Fig. 4-3. Troubleshooting chart for 453A.

Component Replacement

WARNING

Disconnect the instrument from the power source before replacing components.

Removing the Rear Panel. The rear panel must be removed for access to the rear subpanel. This panel can be removed by removing the Z Axis ground strap and the rear feet.

Swing-Out Chassis. Some of the controls and connectors are mounted on a swing-out chassis on the right side of this instrument. To reach the rear of this chassis or the components mounted behind it, first remove the top cover from the instrument. Then, loosen the captive securing screw so the chassis can swing outward.

Circuit Board Replacement. If a circuit board is damaged beyond repair, the entire assembly including all soldered-on components can be replaced. Part numbers are given in the Mechanical Parts List for either the completely wired or the unwired board.

NOTE

Even though unwired boards are available without components, use of the completely wired replacement board is recommended due to the large number of components mounted on most of the boards.

Most of the components mounted on the circuit boards can be replaced without removing the boards from the instrument. Observe the soldering precautions given under Soldering Techniques in this section. However, if the bottom side of the board must be reached or if the board must be moved to gain access to other areas of the instrument, only the mounting screws need to be removed. The interconnecting wires on most of the boards are long enough to allow the board to be moved out of the way or turned over without disconnecting the pin connectors.

GENERAL:

Most of the connections to the circuit boards are made with pin connectors. However, several connections are soldered between the attenuators and Vertical Preamp board. See the special removal instructions to remove these as a unit.

Use the following procedure to remove a circuit board.

1. Disconnect all pin connectors which come through holes in the board.
2. Remove all screws holding the board to the chassis.
3. The board may now be lifted for maintenance or access to areas beneath the board.
4. To completely remove the board, disconnect the remaining pin connectors.
5. Lift the circuit board out of the instrument. Do not force or bend the board.
6. To replace the board, reverse the order of removal. Correct location of the pin connectors is shown by the circuit board pictures in Section 8.

VERTICAL PREAMP UNIT REMOVAL:

Use the following procedure to remove the Vertical Preamp board and the attenuators as a unit.

1. Remove the screw (mounted with a washer) which holds the MODE-INT-TRIG switch (rear of board) to the chassis. The other screw may be left in place.
2. Remove the screw (with fiber washer) from the center of the board.
3. Unsolder the connections on the MODE-INT-TRIG switch which do not go to the Vertical Preamp board.
4. Disconnect all pin connectors which lead off of the Vertical Preamp board.
5. Remove the attenuator shield and remove the nuts (four) located under this shield at each side of the input connectors.
6. Remove the VAR, CH 1 and CH 2 VOLTS/DIV, POSITION, Input Coupling, INT TRIG, and MODE knobs.
7. Remove the securing nuts on the vertical POSITION and the STEP ATTEN BAL controls.
8. Remove the three screws at the rear of the board.

9. Lift up on the rear of the assembly and slide it out of the instrument.

10. The board may now be removed from the Vertical Preamp unit as follows:

a. Disconnect all pin connectors remaining on the board.

b. Unsolder all connections on the rear side of the board which connect between the attenuators and the board. Observe the soldering precautions given in this section.

c. Remove the remaining screw which holds the MODE-INT-TRIG switch to the board.

d. Remove the four screws holding the board to the attenuators.

11. To replace the unit, reverse the order of removal. Be sure the GAIN and INVERT extensions are positioned correctly in the corresponding front-panel holes.

Cathode-Ray Tube Replacement. To replace the cathode-ray tube, proceed as follows:

WARNING

Use care when handling a CRT. Protective clothing and safety glasses should be worn. Avoid striking it on any object which might cause it to crack or implode. When storing a CRT, place it face down on a smooth surface with a protective cover or soft mat under the faceplate to protect it from scratches.

The CRT shield should be handled carefully. This shield protects the CRT display from distortion due to magnetic interference. If the shield is dropped or struck sharply, it may lose its shielding ability.

The following procedure outlines the removal and replacement of the cathode-ray tube:

A. REMOVAL:

1. Remove the top and bottom covers and rear panel as described previously.

2. Remove the light filter or faceplate protector.

3. Disconnect the CRT anode connector. Ground this lead and the anode connection to discharge any stored charge.

4. Unsolder the trace-rotation leads at the CRT shield.

5. Unsolder the y-axis rotation leads at the Y Axis Align control.

6. Disconnect the deflection-plate connectors. Be careful not to bend the deflection-plate pins.

7. Remove the CRT socket.

8. Remove the two nuts (by the graticule lights) which hold the front of the CRT shield to the subpanel.

9. Remove the graticule lights from the studs and position them away from the shield.

10. Loosen the two hex-head screws inside the rear of the CRT shield. Remove the shield angle clamps and mounting screws.

11. Slide the CRT assembly to the rear of the instrument until the faceplate clears the mounting studs. Then, lift the front of the CRT assembly up and slide it out of the instrument.

12. Loosen the three screws on the CRT clamp inside the CRT shield. Do not remove the screws.

13. Hold the left hand on the CRT faceplate and push forward on the CRT base with the right hand. As the CRT starts out of the shield, grasp it firmly with the left hand. When the CRT is free of the clamp, slide the shield completely off the CRT. Be careful not to bend the neck pins.

B. REPLACEMENT:

1. Insert the CRT into the shield. Be careful not to bend the neck pins. Seat the CRT firmly against the shield.

2. Tighten the bottom clamp screws—inside the CRT shield. Recommended tightening torque: 4 to 7 inch-lbs. Do not tighten the screws on the sides.

3. Place the light mask over the CRT faceplate.

4. Using a method similar to that for removal (step 11) re-insert the CRT assembly into the instrument. Be sure the CRT faceplate seats properly in the subpanel.

5. Tighten the two remaining screws on the inside of the CRT shield.

6. Replace the shield angle clamps and mounting screws on the rear subpanel. Tighten the two hex-head screws inside the rear of the CRT shield.

7. Replace the graticule lights and securing nuts.

8. Replace the CRT socket.

9. Reconnect the anode connector. Align the jack on the CRT and the plug in the connector and press firmly on the insulated cover to snap the plug into place.

10. Reconnect the trace-rotation and y-axis leads.

11. Reconnect the deflection-plate connectors. Correct location is indicated on the CRT shield.

12. Adjust the High Voltage, TRACE ROTATION, ASTIG, Y-Axis Align, and Geometry adjustments. Adjustment procedure is given in the Calibration section. Also check the basic vertical and horizontal gain.

Transistor Replacement. Transistors should not be replaced unless actually defective. If removed from their sockets during routine maintenance, return them to their original sockets. Unnecessary replacement of transistors may affect the calibration of this instrument. When transistors are replaced, check the operation of that part of the instrument which may be affected.

CAUTION

POWER switch must be turned off before removing or replacing transistors.

Replacement transistors should be of the original type or a direct replacement. Fig. 4-2 shows the lead configuration of the transistors used in this instrument. Some plastic case transistors have lead configurations which do not agree with those shown here. If a transistor is replaced by a transistor which is made by a different manufacturer than the original, check the manufacturer's basing diagram for correct

basing. All transistor sockets in this instrument are wired for the basing used for metal-case transistors. Transistors which have heat radiators or are mounted on the chassis use silicone grease to increase heat transfer. Replace the silicone grease when replacing these transistors.

WARNING

Handle silicone grease with care. Avoid getting silicone grease in the mouth or eyes. Wash hands thoroughly after use.

Two transistors in both the Channel 1 and Channel 2 Preamp circuit (Vertical Preamp circuit board) are permanently mounted in special temperature compensation blocks. These transistors (along with the temperature compensation block) must be replaced as a unit. When replacing the unit, place it so the reference information faces the left side of the instrument and the PNP transistor (labeled on side of unit) is toward the front of the instrument.

Fuse Replacement. Table 4-4 gives the rating, location, and function of the fuses used in this instrument.

TABLE 4-4

Fuse Ratings

Circuit Number	Rating	Location	Function
F937	2A Fast	Rear subpanel	High voltage
F1101	2A Fast	Line Voltage Selector assembly	115-volt line
F1102	1A Fast	Line Voltage Selector assembly	230-volt line
F1204	0.25A Fast	By power transformer	+150 volts
F1472	0.5A Fast	By power transformer	+75 volts

Rotary Switches. Individual wafers or mechanical parts of rotary switches are normally not replaceable. If a switch is defective, replace the entire assembly. Replacement switches can be ordered either wired or unwired; refer to the Parts List for the applicable part numbers.

When replacing a switch, tag the leads and switch terminals with corresponding identification tags as the leads are disconnected. Then, use the old switch as a guide for installing the new one. An alternative method is to draw a sketch of the switch layout and record the wire color at each terminal. When soldering to the new

switch be careful that the solder does not flow beyond the rivets on the switch terminals. Spring tension of the switch contact can be destroyed by excessive solder.

The swing-out chassis on the right side of the instrument provides access to the side of the TIME/DIV and HORIZ DISPLAY switches. The top and bottom of these switches can be reached for easier repair or removal by removing the B Sweep board (top), or the A Sweep board (bottom).

Power Transformer Replacement. Replace the power transformer only with a direct-replacement Tektronix transformer. When removing the transformer, tag the leads with the corresponding terminal numbers to aid in connecting the new transformer. After the transformer is replaced, check the performance of the complete instrument using the Performance Check procedure.

Power Chassis. The power transistors and other heat dissipating power-supply components are mounted below the Low-Voltage Regulator board. Remove the Low-Voltage Regulator board to reach these components. To reach the underside of the chassis, remove the fan through the rear subpanel.

High-Voltage Compartment. The components located in the high-voltage compartment can be reached for maintenance or replacement by using the following procedure.

1. Remove the bottom cover of the instrument as described in this section.
2. Remove the high-voltage shield.
3. Remove the three screws which hold the cover on the high-voltage compartment.

4. To remove the complete wiring assembly from the high-voltage compartment, unsolder the post-deflection anode lead (heavily insulated lead at side of compartment). The other leads are long enough to allow the assembly to be lifted out of the compartment to reach the parts on the under side.

5. To replace the high-voltage compartment, reverse the order of removal.

NOTE

All solder joints in the high-voltage compartment should have smooth surfaces. Any protrusions may cause high-voltage arcing at high altitudes.

Recalibration After Repair

After any electrical component has been replaced, the calibration of that particular circuit should be checked, as well as the calibration of other closely related circuits. Since the low-voltage supply affects all circuits, calibration of the entire instrument should be checked if work has been done in the low-voltage supply or if the power transformer has been replaced. The Performance Check procedure provides a quick and convenient means of checking instrument operation.

Instrument Repackaging

If the 453A is to be shipped for long distances by commercial means of transportation, it is recommended that the instrument be repackaged in the original manner for maximum protection. The original shipping carton can be saved and used for this purpose. The Repackaging illustration in the Mechanical Parts Illustrations shows how to repackage the 453A and R453A, and gives the part numbers for the repackaging components. New shipping cartons can be obtained from Tektronix, Inc. Contact your local Tektronix Field Office or representative.

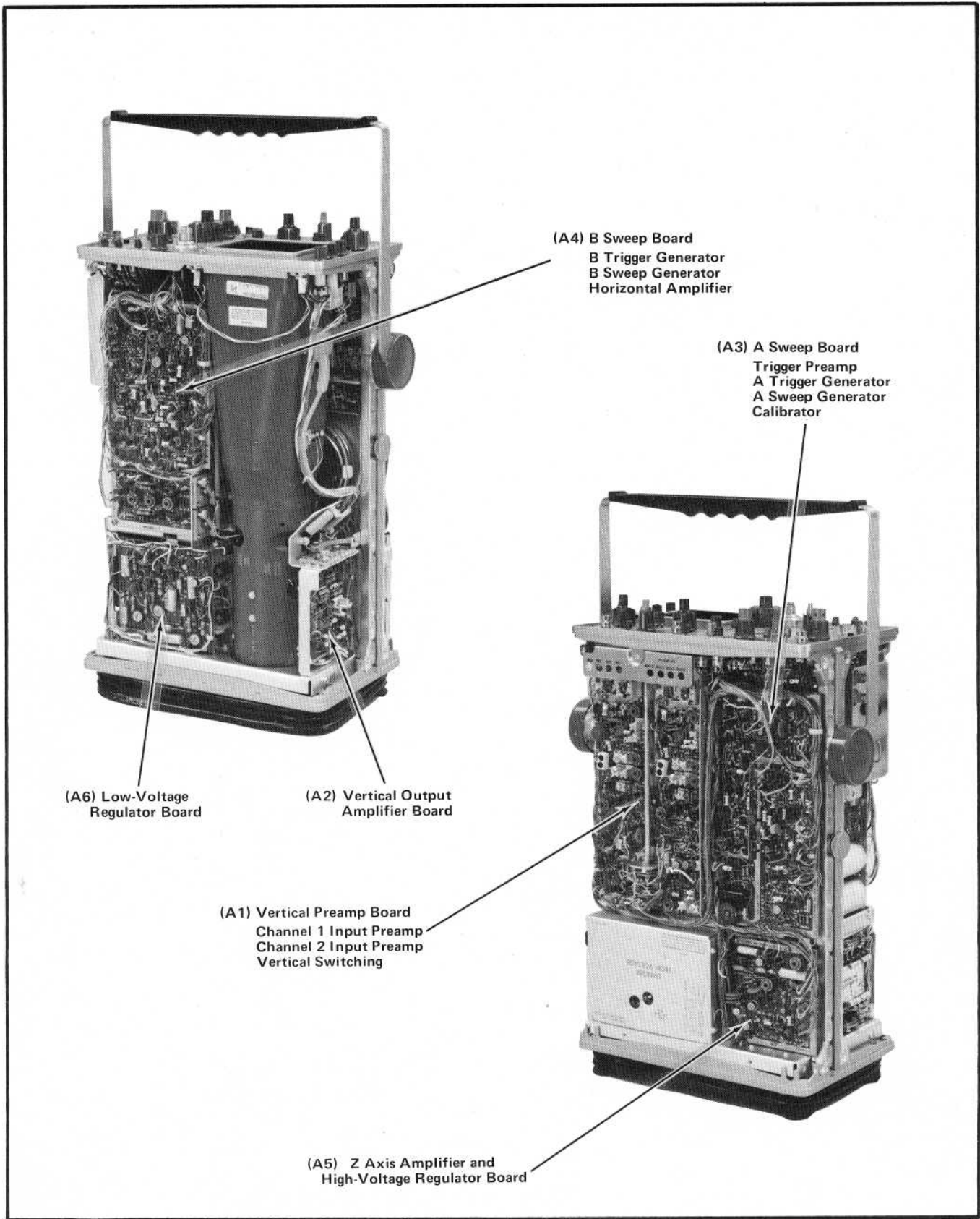


Fig. 4-4. Location of circuit boards in the 453A.

SECTION 5

CALIBRATION

Change information, if any, affecting this section will be found at the rear of this manual.

Introduction

To assure instrument accuracy, check the calibration of the 453A every 1000 hours of operation, or every six months if used infrequently. Before complete calibration, thoroughly clean and inspect this instrument as outlined in the Maintenance section.

Tektronix Field Service

Tektronix, Inc. provides complete instrument repair and recalibration service at local Field Service Centers and the Factory Service Center. Contact your local Tektronix Field Office or representative for further information.

Using This Procedure

General. This section provides several features to facilitate checking or adjusting the 453A. These are:

Index. To aid in locating a step in the Performance Check or Adjustment procedure, an index is given preceding Part I – Performance Check and Part II – Adjustment procedure.

Performance Check. The performance of this instrument can be checked without removing the covers or making internal adjustments by performing only Part I – Performance Check. This procedure checks the instrument against the tolerances listed in the Performance Requirement column of Section 1. Screwdriver adjustments accessible from the outside of the instrument are adjusted as part of the Performance Check procedure. In addition, a cross-reference is provided to the step in Part II – Adjustment which will return the instrument to correct calibration. In most cases, the adjustment step can be performed without changing control settings or equipment connections.

Adjustment Procedure. To return this instrument to correct calibration with the minimum number of steps, perform only Part II – Adjustment. The Adjustment procedure gives the recommended calibration procedure for all circuits in this instrument. It also includes check procedures for those functions which cannot be checked without removing the covers (e.g., power-supply ripple). Procedures are not given for checks which can be made without removing the covers; see Part I – Performance Check for the procedure for these checks.

Partial Procedure. A partial check or adjustment is often desirable after replacing components, or to touch up the adjustment of a portion of the instrument between major recalibrations. To check or adjust only part of the instrument, set the controls as given under Preliminary Control Settings and start with the nearest Equipment Required list preceding the desired portion. To prevent unnecessary recalibration of other parts of the instrument, readjust only if the tolerance given in the CHECK— part of the step is not met. If re-adjustment is necessary, also check the calibration of any steps listed in the INTERACTION— part of the step.

Complete Performance Check/Adjustment. To completely check and adjust all parts of this instrument, perform both Parts I and II. Start the complete procedure by adjusting the power supply as given in the Adjustment procedure. Then perform the Adjustment procedure for a portion of the instrument (e.g., Vertical System Adjustment) and follow this with the Performance Check for the same portion (e.g., Vertical System Check). This method will assure that the instrument is both correctly adjusted and performing within all given specifications.

IMPORTANT NOTE

All waveforms shown in this section were taken with a Tektronix Oscilloscope Camera System, unless noted otherwise.

TEST EQUIPMENT REQUIRED

General

The following test equipment and accessories, or its equivalent, is required for complete calibration of the 453A. Specifications given for the test equipment are the minimum necessary for accurate calibration. Therefore, some of the specifications listed here may be somewhat less precise than the actual performance capabilities of the test equipment. All test equipment is assumed to be correctly calibrated and operating within the listed specifications.

The Performance Check and Adjustment procedures are based on this recommended equipment. If other equipment is substituted, control settings or calibration setup may need to be altered to meet the requirements of the equip-

Calibration—453A/R453A

ment used. Detailed operating instructions for the test equipment are not given in this procedure. Refer to the instruction manual for the test equipment if more information is needed.

Special Calibration Fixtures

Special Tektronix calibration fixtures are used in this procedure only where they facilitate instrument calibration. These special calibration fixtures are available from Tektronix, Inc. Order by part number through your local Tektronix Field Office or representative.

Calibration Equipment Alternatives

All of the test equipment is required to completely check and adjust this instrument. However, some of the items used only for the Performance Check can be deleted without compromising the measurement capabilities of this instrument. For example, the low-frequency sine-wave generator is used only in the Performance Check, and may be deleted if the user does not desire to check common-mode rejection ratio or low-frequency triggering capabilities of this instrument. Equipment used only for the Performance Check procedure is indicated by footnote 1; items required only for the Adjustment procedure are indicated by footnote 2.

Test Equipment

1. Time-mark generator. Marker outputs, Five seconds to 10 nanoseconds; marker accuracy, within 0.1%. Tektronix 2901 Time-Mark Generator recommended.

2. High-frequency constant-amplitude sine-wave generator. Frequency, 350 kilohertz to above 50 megahertz; reference frequency, 50 kilohertz; output amplitude, variable from five millivolts to five volts into 50 ohms or 10 volts unterminated; amplitude accuracy, within 3% of reference as output frequency changes. Tektronix Type 191 Constant Amplitude Signal Generator recommended.

3. Standard amplitude calibrator. Output signal, one-kilohertz square wave and positive DC voltage; output amplitude, five millivolts to 50 volts; amplitude accuracy, within 0.25%; must have chopped display feature (for Performance Check only). Tektronix calibration fixture 067-0502-01 recommended.

4. Low-frequency sine-wave generator.¹ Frequency, 60 hertz to one megahertz; output amplitude, variable from 0.5 volt to 40 volts peak to peak. For example, General Radio 1310-A Oscillator (use General Radio Type 274 QBJ Adapter to provide BNC output).

¹ Required only for Performance Check.

5. Test-oscilloscope system. Bandwidth, DC to 50 megahertz; minimum deflection factor, five millivolts/division; accuracy, within 3%. Tektronix 453A Oscilloscope with P6054 Probe recommended.

6. Variable autotransformer.² Must be capable of supplying at least 120 volt-amperes over a range of 90 to 137 volts (180 to 274 volts for 230-volt nominal line). (If autotransformer does not have an AC voltmeter to indicate output voltage, monitor the output with an AC voltmeter with a range of at least 137 or 274 volts, RMS.) For example, General Radio W10MT3A Metered Variac Autotransformer. (Use General Radio W20HMT3A for 230-volt nominal operation.)

7. Precision DC voltmeter.² Accuracy, within 0.02%; resolution, 50 microvolts; range, zero to 100 volts. For example, Fluke Model 825A Differential DC Voltmeter.

8. DC Voltmeter (VOM).² Range, zero to 2500 volts; accuracy, checked to within 1% at -1960 volts. For example, Triplett Model 630-NA.³

9. Square-wave generator.² Must have the following output capabilities (may be obtained from separate generators): 12 volts amplitude into 50 ohms at one kilohertz with a risetime of 12 nanoseconds or less; 500 millivolts into 50 ohms at 100 kilohertz with a risetime of one nanosecond or less. Tektronix Type 106 Square-Wave Generator recommended (meets both output requirements).

Accessories

10. 18-inch cable. Impedance, 50 ohms; type, RG-58/U; connectors, BNC. Tektronix Part No. 012-0076-00 (supplied accessory).

11. 42-inch cable. Impedance, 50 ohms; type RG-58/U; connectors, BNC. Tektronix Part No. 012-0057-01.

12. Five-nanosecond cable. Impedance, 50 ohms; type, RG-213/U; connectors, GR874. Tektronix Part No. 017-0502-00.

13. In-line GR termination. Impedance, 50 ohms; wattage rating, two watts; accuracy, $\pm 2\%$; connectors, GR874 input with BNC male output. Tektronix Part No. 017-0064-00.

² Required only for Adjustment procedure.

³ If a precision voltage divider is available for use with the precision DC voltmeter (such as Fluke 80E-2), it can be used in place of this meter.

14. BNC T connector.¹ Tektronix Part No. 103-0030-00.

15. BNC to alligator clip adapter.¹ Connectors, BNC female and two alligator clips. Tektronix Part No. 013-0076-00.

16. Dual-input coupler. Matched signal transfer to each input. Tektronix calibration fixture 067-0525-00.

17. 5X GR attenuator. Impedance, 50 ohms; accuracy, ±2%; connectors, GR874. Tektronix Part No. 017-0079-00.

18. 10X probe.¹ Tektronix P6061 recommended (supplied accessory).

19. GR to BNC adapter. Adapts GR874 connector to BNC female connector. Tektronix Part No. 017-0064-00.

20. BNC termination (two). Impedance, 50 ohms; wattage rating, two watts; accuracy, ±2%; connectors, BNC. Tektronix Part No. 011-0049-01.

21. Current-measuring probe and passive termination.¹ Sensitivity, two milliamperes/millivolt; accuracy, within 3%. Tektronix P6021 Current Probe with 011-0105-00 Passive Termination recommended.

22. 1X probe.² Tektronix P6011 recommended.

23. Input RC normalizer.² Time constant, one megohm X 20 picofarads; attenuation, 2X; connectors, BNC. Tektronix calibration fixture 067-0538-00.

Adjustment Tools

24. Screwdriver. Three-inch shaft, 3/32-inch bit. For example, XceLite R-3323.

25. Low-capacitance screwdriver.² 1 1/2-inch shaft. Tektronix Part No. 003-0000-00.

26. Tuning tool.² Handle and insert for 5/64-inch (ID) hex cores. Tektronix Part No. 003-0307-00 and 003-0310-00.

Preliminary Control Settings

Set the 453A controls as follows (for both Performance Check and Adjustment procedure):

Display Controls

INTENSITY	Midrange
FOCUS	Adjust for well defined display
SCALE ILLUM	As desired

Vertical Controls (both channels if applicable)

VOLTS/DIV	20 mV
VAR	Calibrated
POSITION	Midrange
Input Coupling	DC
MODE	CH 1
INT TRIG	NORM
INVERT	Pushed in

Triggering Controls (both A and B)

LEVEL	0
SLOPE	+
COUPLING	AC
SOURCE	INT

Sweep Controls

DELAY-TIME MULTIPLIER	Fully counterclockwise
A and B TIME/DIV	1 ms
A VAR	Calibrated
A SWEEP MODE	AUTO TRIG
B SWEEP MODE	TRIGGERABLE AFTER DELAY TIME
HORIZ DISPLAY	A
MAG	OFF
A SWEEP LENGTH	FULL
POSITION	Midrange
POWER	ON

Side-Panel Controls

B TIME/DIV	CAL
VARIABLE CALIBRATOR	.1 V

PART I — PERFORMANCE CHECK

Introduction

The following procedure checks the performance of the 453A without removing the covers or making internal adjustments. All tolerances given in this procedure are based on Section 1 of this manual.

Index to Part I — Performance Check

DISPLAY and Z-AXIS CHECK

- | | |
|------------------------------------|----------|
| 1. Check Astigmatism | Page 5-6 |
| 2. Check Trace Alignment | Page 5-6 |
| 3. Check Y-Axis Alignment | Page 5-6 |
| 4. Check External Z-Axis Operation | Page 5-6 |

VERTICAL SYSTEM CHECK

- | | |
|--|-----------|
| 5. Check Channel 1 and 2 Step Attenuator Balance | Page 5-7 |
| 6. Check Channel 1 and 2 Gain | Page 5-7 |
| 7. Check Added Mode Operation | Page 5-8 |
| 8. Check Channel 1 and 2 Deflection Accuracy | Page 5-8 |
| 9. Check Channel 1 and 2 Variable Volts/Division Range | Page 5-8 |
| 10. Check Channel 1 and 2 Cascaded Deflection Factor | Page 5-8 |
| 11. Check Alternate Operation | Page 5-9 |
| 12. Check Chopped Operation | Page 5-9 |
| 13. Check Upper Vertical Bandwidth Limit of Channels 1 and 2 | Page 5-9 |
| 14. Check Channel 1 and 2 Cascaded Upper Bandwidth Limit | Page 5-9 |
| 15. Check Common-Mode Rejection Ratio | Page 5-10 |
| 16. Check Amplifier Crosstalk | Page 5-10 |

TRIGGER SYSTEM CHECK

- | | |
|---|-----------|
| 17. Check A and B Internal Triggering Operation | Page 5-11 |
|---|-----------|

- | | |
|---|-----------|
| 18. Check A and B External Triggering Operation | Page 5-11 |
|---|-----------|

- | | |
|--|-----------|
| 19. Check A and B Low-Frequency Triggering Operation | Page 5-11 |
|--|-----------|

- | | |
|---|-----------|
| 20. Check A and B High-Frequency Reject Operation | Page 5-13 |
|---|-----------|

- | | |
|--|-----------|
| 21. Check A and B Low-Frequency Reject Operation | Page 5-13 |
|--|-----------|

- | | |
|----------------------------------|-----------|
| 22. Check Single Sweep Operation | Page 5-14 |
|----------------------------------|-----------|

- | | |
|--|-----------|
| 23. Check A and B Slope Switch Operation | Page 5-14 |
|--|-----------|

- | | |
|--|-----------|
| 24. Check A and B Triggering Level Control Range | Page 5-14 |
|--|-----------|

- | | |
|---|-----------|
| 25. Check A and B Line Triggering Operation | Page 5-15 |
|---|-----------|

- | | |
|--|-----------|
| 26. Check Auto Recovery Time and Operation | Page 5-16 |
|--|-----------|

HORIZONTAL SYSTEM CHECK

- | | |
|---|-----------|
| 27. Check A and B Sweep Timing Accuracy | Page 5-17 |
|---|-----------|

- | | |
|--|-----------|
| 28. Check A and B Magnified Sweep Accuracy | Page 5-18 |
|--|-----------|

- | | |
|-------------------------------|-----------|
| 29. Check Delay-Time Accuracy | Page 5-19 |
|-------------------------------|-----------|

- | | |
|---|-----------|
| 30. Check Delay-Time Multiplier Incremental Linearity | Page 5-19 |
|---|-----------|

- | | |
|-----------------------------|-----------|
| 31. Check Delay-Time Jitter | Page 5-20 |
|-----------------------------|-----------|

- | | |
|---------------------------------|-----------|
| 32. Check Mixed Sweep Operation | Page 5-20 |
|---------------------------------|-----------|

- | | |
|--------------------------|-----------|
| 33. Check A Sweep Length | Page 5-20 |
|--------------------------|-----------|

- | | |
|------------------------------|-----------|
| 34. Check B Ends A Operation | Page 5-21 |
|------------------------------|-----------|

- | | |
|--|-----------|
| 35. Check A and B Variable Control Range | Page 5-21 |
|--|-----------|

- | | |
|------------------|-----------|
| 36. Check X Gain | Page 5-21 |
|------------------|-----------|

- | | |
|-------------------------|-----------|
| 37. Check X-Y Operation | Page 5-22 |
|-------------------------|-----------|

- 38. Check X-Y Phasing Page 5-22
- 39. Check X Bandwidth in X-Y Mode Page 5-22

OUTPUT SIGNALS CHECK

- 40. Check Calibrator Repetition Rate Page 5-23
- 41. Check Calibrator Voltage Output Page 5-23
- 42. Check Current Through Probe Loop Page 5-24
- 43. Check A and B Gate Output Signal Page 5-24

Preliminary Procedure for Performance Check

NOTE

The performance of this instrument can be checked at any temperature within the 0°C to +50°C range unless stated otherwise.

1. Connect the 453A to a power source which meets the voltage and frequency requirements of this instrument.
2. Set the controls as given under Preliminary Control Settings. Allow at least 20 minutes warmup before proceeding.

NOTES

DISPLAY and Z-AXIS CHECK

Equipment Required

1. Time-mark generator
2. High-frequency constant-amplitude sine-wave generator
3. 18-inch 50-ohm BNC cable
4. 42-inch 50-ohm BNC cable
5. Five-nanosecond GR cable
6. In-line 50-ohm GR termination
7. BNC T connector
8. BNC to alligator-clip adapter
9. Three-inch screwdriver

Control Settings

Set the controls as given under Preliminary Control Settings.

1. Check Astigmatism

- a. Connect the 1 kHz CAL connector to the CH 1 OR X connector with the 18-inch BNC cable.
- b. CHECK—CRT display is well defined.
- c. If necessary, adjust the FOCUS control and ASTIG adjustment (side panel) to obtain best display definition.
- d. Disconnect the cable.

2. Check Trace Alignment

- a. Position the trace to the center horizontal line with the Channel 1 POSITION control.
- b. CHECK—Trace aligns with center line within 0.1 division from left to right graticule line.
- c. If necessary, adjust the TRACE ROTATION adjustment (side panel) so the trace is parallel to the center horizontal line.

3. Check Y-Axis Alignment

- a. Connect the time-mark generator to the CH 1 OR X connector with the 18-inch BNC cable.
- b. Set the time-mark generator for one-millisecond markers.
- c. Turn the Channel 1 POSITION control fully counter-clockwise to move the baseline of the marker display as far below the bottom of the graticule as possible.

d. Move a marker to the center vertical line with the horizontal POSITION control.

e. CHECK—Marker aligns with center vertical line within 0.1 division total from top to bottom of the graticule.

f. CALIBRATION—See step 10 of Adjustment procedure.

4. Check External Z-Axis Operation

- a. Change the following control settings:

CH 1 VOLTS/DIV	1 V
Channel 1 POSITION	Midrange
A SOURCE	INT
A TIME/DIV	20 μ s

b. Connect the high-frequency constant amplitude sine-wave generator to the CH 1 OR X connector with the five-nanosecond GR cable, in-line 50-ohm GR termination, and the BNC T connector.

c. Set the generator for a five-volt peak-to-peak output (use calibrated output position of generator) at its reference frequency (50 kilohertz).

d. Remove the ground strap from between the Z AXIS INPUT binding posts.

e. Connect the output of the BNC T connector to the Z AXIS INPUT binding posts with the 42-inch 50-ohm BNC cable and the BNC to alligator clip adapter; connect black lead of alligator clip to ground post.

f. CHECK—CRT display for noticeable intensity modulation (INTENSITY control setting may need to be reduced to observe modulation).

g. Disconnect all test equipment and replace ground strap.

VERTICAL SYSTEM CHECK

Equipment Required

- | | |
|---------------------------------------|----------------------------------|
| 1. Standard amplitude calibrator | 6. 18-inch 50-ohm BNC cable |
| 2. High-frequency sine-wave generator | 7. Five-nanosecond GR cable |
| 3. Low-frequency sine-wave generator | 8. In-Line 50-ohm GR termination |
| 4. 42-inch 50-ohm BNC cable | 9. 5X GR attenuator |
| 5. Dual-input coupler | 10. Three-inch screwdriver |

Control Settings

Set the controls as given under Preliminary Control Settings.

5. Check Channel 1 and 2 Step Attenuator Balance

- a. Set the Channel 1 and 2 Input Coupling switches to GND.
- b. Position the trace to the center horizontal line with the Channel 1 POSITION control.
- c. CHECK—Change the CH 1 VOLTS/DIV switch from 20 mV to 5 mV. Trace should not move more than 0.1 division vertically.

NOTE

Use the BEAM FINDER switch to locate the trace if it is deflected off screen when switching to 10 or 5 mV.

d. If necessary, adjust the Channel 1 STEP ATTEN BAL adjustment (front panel) for no trace shift as the CH 1 VOLTS/DIV switch is changed from 20 mV to 5 mV.

e. Set the MODE switch to CH 2.

f. Position the trace to the center horizontal line with the Channel 2 POSITION control.

g. CHECK— Change the CH 2 VOLTS/DIV switch from 20 mV to 5 mV. Trace should not move more than 0.1 division vertically.

h. If necessary, adjust the Channel 2 STEP ATTEN BAL adjustment (front panel) for no trace shift as the CH 2 VOLTS/DIV switch is changed from 20 mV to 5 mV.

6. Check Channel 1 and 2 Gain

- a. Change the following control settings:

CH 1 and 2 VOLTS/DIV	20 mV
CH 1 and 2 Input Coupling	DC
MODE	CH 1
A TIME/DIV	.5 ms

b. Connect the standard amplitude calibrator output connector to the CH 1 OR X and CH 2 OR Y connectors with a 42-inch BNC cable and the dual-input coupler.

c. Set the standard amplitude calibrator for a 0.1-volt square-wave output.

- d. Center the display on the graticule.

e. CHECK—CRT display for five divisions of deflection.

f. If necessary, adjust the Channel 1 GAIN adjustment (front panel) for exactly five divisions of deflection.

- g. Set the MODE switch to ADD.

h. Pull the INVERT switch.

i. Center the display with the Channel 2 POSITION control.

- j. CHECK—CRT display for straight line.

Performance Check—453A/R453A

k. If necessary, adjust the Channel 2 GAIN adjustment (front panel) for straight line.

7. Check Added Mode Operation

a. Push in the INVERT switch.

b. Set the standard amplitude calibrator for a 50-millivolt square-wave output.

c. CHECK—CRT display five divisions ± 0.15 division in amplitude.

8. Check Channel 1 and 2 Deflection Accuracy

a. Set the MODE switch to CH 1.

b. Set the Channel 2 Input Coupling switch to GND.

c. CHECK—Using the CH 1 VOLTS/DIV switch and standard amplitude calibrator settings given in Table 5-1, check the vertical deflection accuracy within 3% in each position of the CH 1 VOLTS/DIV switch.

d. Set the MODE switch to CH 2.

e. Set the Channel 1 Input Coupling switch to GND and the Channel 2 Input Coupling switch to DC.

f. CHECK—Using the CH 2 VOLTS/DIV switch and standard amplitude calibrator settings given in Table 5-1, check the vertical deflection accuracy within 3% in each position of the CH 2 VOLTS/DIV switch.

9. Check Channel 1 and 2 Variable Volts/Division Range

a. Set the standard amplitude calibrator for a 0.1-volt square-wave output.

b. Change the following control settings:

CH 1 and 2 VOLTS/DIV 20 mV
 CH 1 and 2 Input Coupling AC

c. CHECK—Turn the Channel 2 VAR control fully counterclockwise (minimum gain). Display should be reduced to two divisions or less (indicates adequate range for continuously variable deflection factors between the calibrated steps). Channel 2 UNCAL light must be on when the Channel 2 VAR control is not in the calibrated position.

d. Set the MODE switch to CH 1.

e. CHECK—Turn the Channel 1 VAR control fully counterclockwise (minimum gain). Display should be reduced to two divisions or less (indicates adequate range for continuously variable deflection factors between the calibrated steps). Channel 1 UNCAL light must be on when Channel 1 VAR control is not in the calibrated position.

f. Disconnect all test equipment.

TABLE 5-1

Vertical Deflection Accuracy

VOLTS/DIV switch setting	Standard amplitude calibrator output	Vertical deflection in divisions	Maximum error for $\pm 3\%$ accuracy (divisions)
5 mV	20 millivolts	4	± 0.12
10 mV	50 millivolts	5	± 0.15
20 mV	0.1 volt	5	Previously set in step 6
50 mV	0.2 volt	4	± 0.12
.1	0.5 volt	5	± 0.15
.2	1 volt	5	± 0.15
.5	2 volts	4	± 0.12
1	5 volts	5	± 0.15
2	10 volts	5	± 0.15
5	20 volts	4	± 0.12
10	50 volts	5	± 0.15

10. Check Channel 1 and 2 Cascaded Deflection Factor

a. Connect the CH 1 OUT connector (side panel) to the CH 2 OR Y connector with the 18-inch 50-ohm BNC cable.

b. Connect the standard amplitude calibrator to the CH 1 OR X connector with a 42-inch BNC cable.

c. Change the following control settings:

CH 1 and 2 VOLTS/DIV 5 mV
 CH 1 and 2 VAR Calibrated
 CH 1 and 2 Input Coupling DC

d. Set the standard amplitude calibrator for a five-millivolt square-wave output.

e. Center the display with the Channel 1 POSITION control.

f. Set the MODE switch to CH 2.

g. Center the display with the Channel 2 POSITION control.

h. CHECK—CRT display five divisions or greater in amplitude (less than one millivolt/division minimum deflection factor).

i. Disconnect all test equipment.

11. Check Alternate Operation

a. Set the MODE switch to ALT.

b. Position the traces about two divisions apart.

c. Turn the A TIME/DIV switch throughout its range.

d. CHECK—Trace alternation between Channel 1 and 2 at all sweep rates. At faster sweep rates, alternation will not be apparent; instead display appears as two traces on the screen.

12. Check Chopped Operation

a. Change the following control settings:

MODE	CHOP
A TIME/DIV	.5 μ s

b. Position the traces about four divisions apart.

c. Set the A LEVEL control for a stable display.

d. CHECK—Duration of each complete cycle between 3.4 and 5 divisions (500 kilohertz \pm 20%).

13. Check Upper Vertical Bandwidth Limit of Channels 1 and 2

a. Change the following control settings:

CH 1 VOLTS/DIV	20 mV
MODE	CH 1
A TIME/DIV	20 μ s

b. Connect the high-frequency constant-amplitude sine-wave generator to the CH 1 OR X connector through the five-nanosecond GR cable and the in-line 50-ohm GR termination.

c. Set the generator for a six-division display, centered on the graticule, at its reference frequency (50 kilohertz).

d. Without changing the output amplitude, increase the output frequency of the generator until the display is reduced to 4.2 divisions (-3 dB point).

e. CHECK—Output frequency of generator must be 60 megahertz or higher. Actual frequency _____ megahertz.

f. Set the CH 1 VOLTS/DIV switch to 10 mV.

g. Repeat parts c and d of this step.

h. CHECK—Output frequency of generator must be 50 megahertz or higher. Actual frequency _____ megahertz.

i. Set the CH 1 VOLTS/DIV switch to 5 mV.

j. Repeat parts c and d of this step.

k. CHECK—Output frequency of generator must be 40 megahertz or higher. Actual frequency _____ megahertz.

l. Set the MODE switch to CH 2.

m. Disconnect the termination from Channel 1 and connect it to the CH 2 OR Y connector.

n. Repeat parts c and d of this step.

o. CHECK—Output frequency of generator must be 40 megahertz or higher. Actual frequency _____ megahertz.

p. Set the CH 2 VOLTS/DIV switch to 10 mV.

q. Repeat parts c and d of this step.

r. CHECK—Output frequency of generator must be 50 megahertz or higher. Actual frequency _____ megahertz.

Performance Check—453A/R453A

s. Set the CH 2 VOLTS/DIV switch to 20 mV.

t. Repeat parts c and d of this step.

u. CHECK—Output frequency of generator must be 60 megahertz or higher. Actual frequency _____ megahertz.

v. Disconnect all test equipment.

14. Check Channel 1 and 2 Cascaded Upper Bandwidth Limit

a. Connect the high-frequency constant amplitude generator to the CH 1 OR X connector with the five-nanosecond GR cable, 5X GR attenuator, and in-line 50-ohm GR termination, in given order.

b. Connect the CH 1 OUT connector to the CH 2 OR Y connector with the 18-inch 50-ohm BNC cable.

c. Set the CH 2 VOLTS/DIV switch to 5 mV.

d. Set the generator for a six-division display, centered on the graticule, at its reference frequency (50 kilohertz).

e. Without changing the output amplitude, increase the output frequency of the generator until the deflection is reduced to 4.2 divisions (−3 dB point).

f. CHECK—Output frequency of generator must be 25 megahertz or higher. Actual frequency _____ megahertz.

g. Disconnect all test equipment.

15. Check Common-Mode Rejection Ratio

a. Change the following control settings:

CH 1 and 2 VOLTS/DIV	20 mV
A TIME/DIV	.1 ms

b. Connect the low-frequency generator to the CH 1 OR X and CH 2 OR Y connectors with the five-nanosecond GR cable, in-line 50-ohm GR termination, and the dual-input coupler.

c. Set the constant-amplitude generator for an eight-division display at one kilohertz.

d. Change the following control settings:

MODE	ADD
INVERT	Pulled out

e. CHECK—CRT display for 0.4-division or less deflection (common-mode rejection ratio 20:1 or better).

f. Disconnect all test equipment.

16. Check Amplifier Crosstalk

a. Connect the high-frequency generator to the CH 1 OR X connector with the five-nanosecond GR cable and in-line 50-ohm GR termination.

b. Change the following control settings:

CH 1 VOLTS/DIV	.2
MODE	CH 1
INVERT	Pushed in

c. Set the generator for a two-division display at 20 megahertz.

d. Set the MODE switch to CH 2.

e. Set the CH 1 and CH 2 VOLTS/DIV switches to 20 mV.

f. CHECK—CRT display for 0.2-division or less deflection (amplifier crosstalk ratio 100:1 or better).

g. Disconnect the termination from Channel 1 and connect it to the CH 2 OR Y connector.

h. Set the CH 2 VOLTS/DIV switch to .2.

i. Set the generator for a two-division display at 20 megahertz.

j. Change the following control settings:

CH 2 VOLTS/DIV	20 mV
MODE	CH 1

k. CHECK—CRT display for 0.2-division or less deflection.

l. Disconnect all test equipment.

TRIGGER SYSTEM CHECK

Equipment Required

- | | |
|--|----------------------------------|
| 1. High-frequency constant-amplitude sine-wave generator | 6. In-Line 50-ohm GR termination |
| 2. Low-frequency sine-wave generator | 7. GR to BNC female adapter |
| 3. Time-mark generator | 8. BNC T connector |
| 4. 10X probe | 9. 18-inch 50-ohm BNC cable |
| 5. Five-nanosecond GR cable | 10. 50-ohm BNC termination (two) |
| | 11. 42-inch 50-ohm BNC cable |

Control Settings

Set the controls as given under Preliminary Control Settings.

17. Check A and B Internal Triggering Operation

a. Connect the high-frequency constant-amplitude sine-wave generator to the CH 1 OR X connector with the five-nanosecond GR cable and in-line 50-ohm GR termination.

b. Change the following control settings:

CH 1 VOLTS/DIV	50 mV
A and B TIME/DIV	.1 μ s
A SWEEP MODE	NORM TRIG

c. Set the generator for a 0.3-division display at 10 megahertz.

d. CHECK—Stable CRT display can be obtained with the A COUPLING switch set to AC, LF REJ, and DC (A LEVEL control may be adjusted as necessary to obtain stable display). The A SWEEP TRIG'D light must be on when the display is stable.

e. Change the following control settings:

A COUPLING	AC
A LEVEL	Set for stable A display
HORIZ DISPLAY	B (DELAYED SWEEP)

f. CHECK—Stable CRT display can be obtained with the B COUPLING switch set to AC, LF REJ, and DC (B LEVEL control may be adjusted as necessary to obtain a stable display).

g. Change the following control settings:

HORIZ DISPLAY	A
MAG	X10

h. Set the generator for a 1.5-division display at 60 megahertz.

i. CHECK—Stable CRT display can be obtained with the A COUPLING switch set to AC, LF REJ, and DC (A LEVEL and HF STAB controls may be adjusted as necessary to obtain a stable display). Display jitter should not exceed 0.1 division (one nanosecond).

j. Change the following control settings:

A LEVEL	Set for stable A display
A COUPLING	AC
HORIZ DISPLAY	B (DELAYED SWEEP)

k. CHECK—Stable CRT display can be obtained with the B COUPLING switch set to AC, LF REJ, and DC (B LEVEL control may be adjusted as necessary to obtain stable display).

l. Disconnect all test equipment.

18. Check A and B External Triggering Operation

a. Change the following control settings:

A and B SOURCE	EXT
HORIZ DISPLAY	A
MAG	OFF

Performance Check—453A/R453A

b. Connect the high-frequency constant-amplitude sine-wave generator to the CH 1 OR X connector through the five-nanosecond GR cable, GR to BNC adapter, BNC T connector, and 50-ohm BNC termination. Connect the output of the BNC T connector to the A EXT TRIG INPUT connector with the 18-inch 50-ohm BNC cable and the 50-ohm BNC termination.

c. Set the generator for a one-division display (50 millivolts) at 10 megahertz.

d. CHECK—Stable CRT display can be obtained with the A COUPLING switch set to AC, LF REJ, and DC (A LEVEL control may be adjusted as necessary to obtain stable display).

e. Disconnect the termination from the A EXT TRIG INPUT connector and connect it to the B EXT TRIG OR X INPUT connector.

f. Change the following control settings:

A SOURCE	INT
A LEVEL	Set for stable A display
HORIZ DISPLAY	B (DELAYED SWEEP)

g. CHECK—Stable CRT display can be obtained with the B COUPLING switch set to AC, LF REJ, and DC (B LEVEL control may be adjusted as necessary to obtain stable display).

h. Disconnect the termination from the B EXT TRIG OR X INPUT connector and connect it to the A EXT TRIG INPUT connector.

i. Change the following control settings:

A SOURCE	EXT
HORIZ DISPLAY	A
MAG	X10

j. Set the generator for a four-division display (200 millivolts) at 10 megahertz.

k. Without changing the output amplitude, increase the output frequency of the generator to 60 megahertz.

l. CHECK—Stable CRT display can be obtained with the A COUPLING switch set to AC, LF REJ, and DC (A LEVEL and HF STAB controls may be adjusted as necessary to obtain stable display).

m. Disconnect the termination from the A EXT TRIG INPUT connector and connect it to the B EXT TRIG OR X INPUT connector.

n. Change the following control settings:

A SOURCE	INT
A LEVEL	Set for stable A display
HORIZ DISPLAY	B (DELAYED SWEEP)

o. CHECK—Stable CRT display can be obtained with the B COUPLING switch set to AC, LF REJ, and DC (B LEVEL control may be adjusted as necessary to obtain stable display).

p. Disconnect all test equipment.

19. Check A and B Low-Frequency Triggering Operation

a. Connect the low-frequency sine-wave generator to the CH 1 OR X connector with the 42-inch 50-ohm BNC cable, BNC T connector, and the 50-ohm BNC termination. Connect the output of the BNC T connector to the A EXT TRIG INPUT connector with the 18-inch 50-ohm BNC cable and a 50-ohm BNC termination.

b. Change the following control settings:

A and B TIME/DIV	5 ms
HORIZ DISPLAY	A
MAG	OFF

c. Set the generator for a 0.3-division display at 60 hertz.

d. CHECK—Stable CRT display can be obtained with the A COUPLING switch set to AC, HF REJ, and DC (A LEVEL control may be adjusted as necessary to obtain a stable display).

e. Change the following control settings:

A COUPLING	AC
A LEVEL	Set for stable A display
HORIZ DISPLAY	B (DELAYED SWEEP)

f. CHECK—Stable CRT display can be obtained with the B COUPLING switch set to AC, HF REJ, and DC (B LEVEL control may be adjusted as necessary to obtain stable display).

g. Change the following control settings:

A and B SOURCE	EXT
HORIZ DISPLAY	A

h. Set the generator for a one-division display (50 millivolts) at 60 hertz.

i. CHECK—Stable CRT display can be obtained with the A COUPLING switch set to AC, HF REJ, and DC (A LEVEL control may be adjusted as necessary to obtain stable display).

j. Change the following control settings:

A COUPLING	AC
A SOURCE	INT
A LEVEL	Set for stable A display
HORIZ DISPLAY	B (DELAYED SWEEP)

k. Disconnect the termination from the A EXT TRIG INPUT connector and connect it to the B EXT TRIG OR X INPUT connector.

l. CHECK—Stable CRT display can be obtained with the B COUPLING switch set to AC, HF REJ, and DC (B LEVEL control may be adjusted as necessary to obtain stable display).

20. Check A and B High-Frequency Reject Operation

a. Change the following control settings:

A and B COUPLING	HF REJ
A and B SOURCE	INT
A and B TIME/DIV	20 μ s
HORIZ DISPLAY	A

b. Set the low-frequency generator for a 0.3-division display at 50 kilohertz.

c. CHECK—Stable CRT display can be obtained with the A LEVEL control.

d. Without changing the output amplitude, set the generator to one megahertz.

e. Set the MAG switch to X10.

f. CHECK—Stable CRT display cannot be obtained at any setting of the A LEVEL control.

g. Without changing the output amplitude, return the generator to 50 kilohertz.

h. Change the following control settings:

A COUPLING	AC
A LEVEL	Set for stable A display
HORIZ DISPLAY	B (DELAYED SWEEP)
MAG	OFF

i. CHECK—Stable CRT display can be obtained with the B LEVEL control.

j. Without changing the output amplitude, set the generator to one megahertz.

k. Set the MAG switch to X10.

l. CHECK—Stable display cannot be obtained at any setting of the B LEVEL control.

21. Check A and B Low-Frequency Reject Operation

a. Change the following control settings:

A and B COUPLING	LF REJ
A and B TIME/DIV	.1 ms
HORIZ DISPLAY	A
MAG	OFF

b. Set the low-frequency generator for a 0.3-division display at 30 kilohertz.

c. CHECK—Stable CRT display can be obtained with the A LEVEL control.

d. Without changing the output amplitude, set the generator to 60 hertz.

e. Set the A and B TIME/DIV switch to 2 ms.

f. CHECK—Stable CRT display cannot be obtained at any setting of the A LEVEL control.

g. Without changing the output amplitude, set the generator to 30 kilohertz.

Performance Check—453A/R453A

h. Change the following control settings:

A COUPLING	AC
A and B TIME/DIV	.1 ms
A LEVEL	Set for stable A display
HORIZ DISPLAY	B (DELAYED SWEEP)

i. CHECK—Stable CRT display can be obtained with the B LEVEL control.

j. Without changing the output amplitude, set the generator to 60 hertz.

k. Set the A and B TIME/DIV switch to 2 ms.

l. CHECK—Stable CRT display cannot be obtained at any setting of the B LEVEL control.

22. Check Single Sweep Operation

a. Change the following control settings:

A and B TIME/DIV	5 ms
HORIZ DISPLAY	A

b. Set the low-frequency generator for a five-division display at one kilohertz.

c. Change the following control settings:

A LEVEL	Fully clockwise
A SWEEP MODE	SINGLE SWEEP

d. Push the RESET button once.

e. CHECK—RESET light comes on when button is pressed and remains on until sweep is triggered.

f. Slowly rotate the A LEVEL control counterclockwise.

g. CHECK—A single-sweep display (one sweep only) is presented when the A LEVEL control is in the triggerable region. RESET light goes off at the end of the sweep and remains off until the RESET button is pressed again.

23. Check A and B Slope Switch Operation

a. Change the following control settings:

A and B LEVEL	0
B COUPLING	AC
A and B TIME/DIV	.5 ms
A SWEEP MODE	AUTO TRIG

b. Set the low-frequency generator for a four-division display at one kilohertz.

c. CHECK—CRT display starts on positive slope of the waveform.

d. Set the A SLOPE switch to —.

e. CHECK—CRT display starts on negative slope of the waveform.

f. Set the HORIZ DISPLAY switch to B (DELAYED SWEEP).

g. CHECK—CRT display starts on positive slope of the waveform.

h. Set the B SLOPE switch to --.

i. CHECK—CRT display starts on negative slope of the waveform.

j. Disconnect all test equipment.

24. Check A and B Triggering Level Control Range

a. Connect the low-frequency generator to the CH 1 OR X connector with the 42-inch BNC cable and the BNC T connector. Connect the output of the BNC T connector to the B EXT TRIG OR X INPUT connector with the 18-inch BNC cable.

b. Change the following control settings:

CH 1 VOLTS/DIV	1
A and B LEVEL	Midrange
A and B COUPLING	DC
B SOURCE	EXT

c. Set the generator for a four-division display at one kilohertz.

d. CHECK—Rotate the B LEVEL control throughout its range and check that display can be triggered at any point along the negative slope of the waveform (indicates B LEVEL control range of at least + and — two volts). Display is not triggered at either extreme of rotation.

e. Set the B SLOPE switch to +.

f. CHECK—Rotate the B LEVEL control throughout its range and check that display can be triggered at any point along the positive slope of the waveform. Display is not triggered at either extreme of rotation.

g. Change the following control settings:

CH 1 VOLTS/DIV	10
B SOURCE	EXT ÷ 10

h. Set the generator for a four-division display at one kilohertz.

i. CHECK—Rotate the B LEVEL control throughout its range and check that display can be triggered at any point along the positive slope of the waveform (indicates B LEVEL control range of at least + and – 20 volts). Display is not triggered at either extreme of rotation.

j. Set the B SLOPE switch to –.

k. CHECK—Rotate the B LEVEL control throughout its range and check that display can be triggered at any point along the negative slope of the waveform. Display is not triggered at either extreme of rotation.

l. Change the following control settings:

A SOURCE	EXT ÷ 10
A SWEEP MODE	NORM TRIG
HORIZ DISPLAY	A

m. Disconnect the cable from the B EXT TRIG OR X INPUT connector and connect it to the A EXT TRIG INPUT connector.

n. CHECK—Rotate the A LEVEL control throughout its range and check that display can be triggered at any point along the negative slope of the waveform (indicates A LEVEL control range of at least + and – 20 volts). Display is not triggered at either extreme of rotation.

o. Set the A SLOPE switch to +.

p. CHECK—Rotate the A LEVEL control throughout its range and check that display can be triggered at any point along the positive slope of the waveform. Display is not triggered at either extreme of rotation.

q. Change the following control settings:

CH 1 VOLTS/DIV	1
A SOURCE	EXT

r. Set the generator for a four-division display at one kilohertz.

s. CHECK—Rotate the A LEVEL control throughout its range and check that display can be triggered at any point along the positive slope of the waveform (indicates A LEVEL control range of at least + and – two volts). Display is not triggered at either extreme of rotation.

t. Set the A SLOPE switch to –

u. CHECK—Rotate the A LEVEL control throughout its range and check that display can be triggered at any point along the negative slope of the waveform. Display is not triggered at either extreme of rotation.

v. Disconnect all test equipment.

25. Check A and B Line Triggering Operation

a. Connect the 10X probe to the CH 1 OR X connector.

b. Change the following control settings:

CH 1 VOLTS/DIV	10
A and B SOURCE	LINE
A and B TIME/DIV	2 ms

c. Connect the probe tip to the same line-voltage source which is connected to this instrument.

d. CHECK—Stable CRT display, triggered on the correct slope.

e. Set the HORIZ DISPLAY switch to B (DELAYED SWEEP).

f. CHECK—Stable CRT display, triggered on the correct slope.

g. Disconnect all test equipment.

26. Check Auto Recovery Time and Operation

a. Change the following control settings:

CH 1 and 2 VOLTS/DIV	.5
A SLOPE	+
A COUPLING	AC
A SOURCE	INT
A TIME/DIV	50 μ s
A SWEEP MODE	AUTO TRIG
HORIZ DISPLAY	A

b. Connect the marker output of the time-mark generator to the CH 1 OR X connector with the 42-inch 50-ohm BNC cable and the 50-ohm BNC termination.

c. Set the time-mark generator for 50-millisecond markers.

d. CHECK—Stable CRT display can be obtained with the A LEVEL control. Marker must be at the start of the sweep.

e. Set the time-mark generator for 0.1-second markers.

f. CHECK—Sweep free runs and stable display cannot be obtained with the A LEVEL control. If stable display is obtained, marker must not be at the start of the sweep.

g. Disconnect all test equipment.

NOTES

HORIZONTAL SYSTEM CHECK

Equipment Required

- | | |
|--|----------------------------------|
| 1. Time-mark generator | 5. 50-ohm BNC termination |
| 2. Standard amplitude calibrator | 6. Five-nanosecond GR cable |
| 3. High-frequency constant-amplitude sine-wave generator | 7. In-line 50-ohm GR termination |
| 4. 42-inch 50-ohm BNC cable | 8. Dual-input coupler |

Control Settings

Set the controls as given under Preliminary Control Settings.

27. Check A and B Sweep Timing Accuracy

a. Connect the marker output of the time-mark generator to the CH 1 OR X connector with the 42-inch 50-ohm BNC cable and the 50-ohm BNC termination.

b. Change the following control settings:

CH 1 VOLTS/DIV	.5
A SWEEP MODE	NORM TRIG
A LEVEL	Set for stable display

c. CHECK—Using the A TIME/DIV switch and time-mark generator settings given in Table 5-2, check A sweep timing within 0.24 division (within 3%) over the middle eight divisions of the display (if outside the 0°C to +40°C range, see Section 1 for applicable tolerances).

NOTE

Unless otherwise noted, use the middle eight horizontal divisions when checking timing.

d. Set the A TIME/DIV switch to 1 ms.

e. Set the time-mark generator for one-millisecond markers.

f. Position the second marker to the second vertical line of the graticule.

g. CHECK—Fourth marker within 0.1 division (within 5%) of the fourth vertical line.

TABLE 5-2

A and B Timing Accuracy

A and B TIME/DIV switch setting	Time-mark generator output	CRT display (markers/ division)
.1 μs	0.1 microsecond	1
.2 μs	0.1 microsecond	2
.5 μs	0.5 microsecond	1
1 μs	1 microsecond	1
2 μs	1 microsecond	2
5 μs	5 microsecond	1
10 μs	10 microsecond	1
20 μs	10 microsecond	2
50 μs	50 microsecond	1
.1 ms	0.1 millisecond	1
.2 ms	0.1 millisecond	2
.5 ms	0.5 millisecond	1
1 ms	1 millisecond	1
2 ms	1 millisecond	2
5 ms	5 millisecond	1
10 ms	10 millisecond	1
20 ms	10 millisecond	2
50 ms	50 millisecond	1
.1 s	0.1 second	1
.2 s	0.1 second	2
.5 s	0.5 second	1
A Sweep Only		
1 s	1 second	1
2 s	1 second	2
5 s	5 second	1

h. Position the third marker to the third vertical line.

i. CHECK—Fifth marker within 0.1 division of the fifth vertical line.

Performance Check—453A/R453A

j. Continue this check for each two-division portion of the sweep within the center eight divisions of the graticule.

k. CALIBRATION—See steps 21, 22, 23, and 27 of Adjustment procedure.

l. Set the HORIZ DISPLAY switch to B (DELAYED SWEEP).

m. Set the B LEVEL control for a stable display.

n. CHECK—Using the A and B TIME/DIV switch and time-mark generator settings given in Table 5-2, check B sweep timing within 0.24 division (within 3%) over the middle eight divisions of the display (if outside the 0°C to +40°C range, see Section 1 for applicable tolerances).

o. CALIBRATION—See step 25 of Adjustment procedure.

g. Position the third displayed marker to the third vertical line.

h. CHECK—Fifth displayed marker within 0.1 division of the fifth vertical line.

i. Continue this check for each two-division portion of the displayed sweep within the center eight divisions of the graticule.

j. CALIBRATION—See step 23 of Adjustment procedure.

28. Check A and B Magnified Sweep Accuracy

a. Change the following control settings:

HORIZ DISPLAY A
MAG X10
Horizontal POSITION Centered

b. CHECK—Using the A TIME/DIV switch and time-mark generator settings given in Table 5-3, check A magnified sweep timing within 0.32 division (within 4%) over the middle eight divisions of the total magnified display (if outside the 0°C to +40°C range, see Section 1 for applicable tolerances). Note the portions of the total magnified sweep length to be excluded from measurement. Magnifier light must be on. The vertical deflection factor must be reduced to .1 to display the 10-nanosecond markers.

c. Set the A TIME/DIV switch to 1 ms.

d. Set the time-mark generator for 0.1-millisecond markers.

e. Position the second displayed marker to the second vertical line of the graticule.

f. CHECK—Fourth displayed marker within 0.1 division (within 5%) of the fourth vertical line.

**TABLE 5-3
A and B Magnified Accuracy**

A and B TIME/DIV switch setting	Time-mark generator output	CRT display (markers/division)	Portions of total magnified sweep length to exclude from measurement
.1 μs	10 nanosecond	1	First and last three divisions
.2 μs	10 nanosecond	2	First and last 3.5 divisions
.5 μs	50 nanosecond	1	First two divisions
1 μs	0.1 microsecond	1	First division
2 μs	0.1 microsecond	2	
5 μs	0.5 microsecond	1	
10 μs	1 microsecond	1	
20 μs	1 microsecond	2	
50 μs	5 microsecond	1	
.1 ms	10 microsecond	1	
.2 ms	10 microsecond	2	
.5 ms	50 microsecond	1	
1 ms	0.1 millisecond	1	
2 ms	0.1 millisecond	2	
5 ms	0.5 millisecond	1	
10 ms	1 millisecond	1	
20 ms	1 millisecond	2	
50 ms	5 millisecond	1	
.1 s	10 millisecond	1	
.2 s	10 millisecond	2	
.5 s	50 millisecond	1	
A Sweep Only			
1 s	0.1 second	1	
2 s	0.1 second	2	
5 s	0.5 second	1	

k. Set the HORIZ DISPLAY switch to B (DELAYED SWEEP).

l. CHECK—Using the A and B TIME/DIV switch and time-mark generator settings given in Table 5-3, check B magnified sweep timing within 0.32 division (within 4%) over the middle eight divisions of the total magnified display (if outside the 0°C to +40°C range, see Section 1 for applicable tolerances).

29. Check Delay-Time Accuracy

a. Change the following control settings:

B SWEEP MODE	B STARTS AFTER
	DELAY TIME
MAG	OFF

b. CHECK—Using the A TIME/DIV switch, B TIME/DIV switch, and time-mark generator settings given in Table 5-4, check delayed sweep accuracy within the given tolerance. First set the DELAY-TIME MULTIPLIER dial to 1.00 and rotate the dial until the sweep starts at the top of the

second marker. Note the exact dial reading, then set the dial to 9.00, and rotate slightly until the sweep starts at the top of the tenth marker. DELAY-TIME MULTIPLIER dial setting must be 8.00 divisions higher, + or – the allowable error given in Table 5-4 (if outside the 0°C to +40°C range, see Section 1 for applicable tolerances).

NOTE

Sweep will start at top of third marker at 1.00 and nineteenth marker at 9.00 for sweep rates which are multiples of two (e.g., 2 μs, 20 μs, .2 ms, etc.). If in doubt as to the correct setting of the DELAY-TIME MULTIPLIER dial, set the HORIZ DISPLAY switch to A INTEN DURING B and check which marker is intensified.

c. CALIBRATION—See steps 21, 22, and 25 of Adjustment procedure.

30. Check Delay-Time Multiplier Incremental Linearity

a. Change the following control settings:

DELAY-TIME MULTIPLIER	9.00
A TIME/DIV	1 ms
B TIME/DIV	10 μs

b. Set the time-mark generator for one-millisecond markers.

NOTE

If the display is not exactly 8.00 dial divisions between 1.00 and 9.00 as measured in step 29, use parts c through k to compensate for this error. Then, the incremental linearity of the DELAY-TIME MULTIPLIER dial can be read directly from the dial. If the difference is exactly eight divisions, proceed to part l of this step.

c. Set the A TIME/DIV switch to .5 ms; then return the B TIME/DIV switch to 10 μs.

d. Set the HORIZ DISPLAY switch to A.

e. Set the A VAR control for one marker each division between the first- and ninth-division vertical lines.

f. Set the HORIZ DISPLAY switch to B (DELAYED SWEEP).

TABLE 5-4
Delayed Sweep Accuracy

A TIME/DIV switch setting	B TIME/DIV switch setting	Time-mark generator output	Allowable error for given accuracy 0°C to +40°C
1 μs	.1 μs	1 microsecond	±12 minor dial divisions (±1.5%)
2 μs	.1 μs	1 microsecond	
5 μs	.5 μs	5 microsecond	
10 μs	1 μs	10 microsecond	
20 μs	1 μs	10 microsecond	
50 μs	5 μs	50 microsecond	
.1 ms	10 μs	0.1 millisecond	
.2 ms	10 μs	0.1 millisecond	
.5 ms	50 μs	0.5 millisecond	
1 ms	.1 ms	1 millisecond	
2 ms	.1 ms	1 millisecond	
5 ms	.5 ms	5 millisecond	
10 ms	1 ms	10 millisecond	
20 ms	1 ms	10 millisecond	
50 ms	5 ms	50 millisecond	
.1 s	10 ms	0.1 second	±20 minor dial divisions (±2.5%)
.2 s	10 ms	0.1 second	
.5 s	50 ms	0.5 second	
1 s	.1 s	1 second	
2 s	.1 s	1 second	
5 s	.5 s	5 second	

Performance Check—453A/R453A

g. Set the DELAY-TIME MULTIPLIER dial to 1.00 and rotate slightly until a marker is displayed at the start of the sweep. Note the dial reading.

h. Set the DELAY-TIME MULTIPLIER dial exactly 8.00 dial divisions higher than the reading in part g.

i. Turn the A VAR control slightly so a marker is displayed at the start of the sweep.

j. Set the HORIZ DISPLAY switch to A INTEN DURING B and check that the tenth marker is intensified.

k. Return the HORIZ DISPLAY switch to B (DELAYED SWEEP) and repeat parts g through j until the difference between the markers at about 1.00 and 9.00 is exactly 8.00 dial divisions.

l. Set the DELAY-TIME MULTIPLIER dial to 9.00; then rotate the dial slightly so a marker is displayed at the start of the sweep.

m. Note the exact DELAY-TIME MULTIPLIER dial reading; the difference between this reading and 9.00 is the basic dial error to be used in checking linearity.

n. Set the DELAY-TIME MULTIPLIER dial to 8.00; then rotate the dial slightly so a marker is displayed at the start of the sweep.

o. CHECK—Dial reading should be 8.00 ± 2 minor dial divisions (within 0.2%). Take into account the basic dial error at 9.00.

p. Repeat this check at each major dial division between 8.00 and 1.00.

31. Check Delay-Time Jitter

a. Change the following control settings:

DELAY-TIME MULTIPLIER	1.00
A TIME/DIV	1 ms
B TIME/DIV	1 μ s
A VAR	Calibrated

b. Position the pulse near the center of the display area with the DELAY-TIME MULTIPLIER dial.

c. CHECK—Jitter on the leading edge of the pulse should not exceed 0.5 division (1 part in 20,000). Disregard slow drift.

d. Turn the DELAY-TIME MULTIPLIER dial to 9.00 and adjust so the pulse is displayed near the center of the graticule.

e. CHECK—Jitter on leading edge of the pulse should not exceed 0.5 division. Disregard slow drift.

32. Check Mixed Sweep Operation

a. Change the following control settings:

DELAY-TIME MULTIPLIER	10.00
B TIME/DIV	.5 ms
HORIZ DISPLAY	A

b. CHECK—Timing between second and tenth markers. Note the error for part d.

c. Set the HORIZ DISPLAY switch to MIXED.

d. CHECK—Timing between second and tenth marker within 0.16 division \pm the A sweep error noted in part b (within 2% \pm measured A sweep error).

e. Set the DELAY-TIME MULTIPLIER dial to 0.20.

f. Set the time-mark generator for 0.5-millisecond markers.

g. CHECK—Timing between second and tenth marker within 0.16 division.

33. Check A Sweep Length

a. Set the time-mark generator for one- and 0.1-millisecond markers.

b. Set the HORIZ DISPLAY switch to A.

c. Set the A LEVEL control clockwise to obtain a stable display in the positive triggering area.

d. Move the eleventh marker to the center vertical line with the horizontal POSITION control.

e. CHECK—A sweep length must be at least 10 divisions as shown by the divisions of display to the right of the center vertical line. Large markers indicate divisions and small markers indicate 0.1 division.

f. Position the first marker to the left graticule line.

g. Turn the A SWEEP LENGTH control to 4 DIV (not in B ENDS A detent).

h. CHECK—A sweep length must be four divisions or less.

34. Check B Ends A Operation

a. Change the following control settings:

B TIME/DIV	.1 ms
HORIZ DISPLAY	A INTEN DURING B
A SWEEP LENGTH	B ENDS A

b. Rotate the DELAY-TIME MULTIPLIER dial throughout its range.

c. CHECK—CRT display ends after the intensified portion at all DELAY-TIME MULTIPLIER dial settings.

35. Check A and B Variable Control Range

a. Change the following control settings:

DELAY-TIME MULTIPLIER	0.20
B TIME/DIV	1 ms
HORIZ DISPLAY	A
A SWEEP LENGTH	FULL

b. Set the time-mark generator for 10-millisecond markers.

c. Set the A LEVEL control for a stable display.

d. Position the markers to the far left and right graticule lines with the horizontal POSITION control.

e. Turn the A VAR control fully counterclockwise.

f. CHECK—CRT display for four-division maximum spacing between markers (indicates adequate range for continuously variable sweep rate between calibrated steps).

UNCAL A OR B light must be on when A VAR control is not in calibrated position.

g. Change the following control settings:

A TIME/DIV	5 ms
B TIME/DIV	1 ms
A VAR	Calibrated
B SWEEP MODE	TRIGGERABLE AFTER DELAY TIME
HORIZ DISPLAY	B (DELAYED SWEEP)

h. Position the markers to the far left and right graticule lines with the horizontal POSITION control.

i. Turn the B TIME/DIV VARIABLE control (on side panel) fully counterclockwise.

j. CHECK—CRT display for four-division maximum spacing between markers (indicates adequate range for continuously variable sweep rate between calibrated steps). UNCAL A OR B light must be on when B TIME/DIV VARIABLE control is not in CAL position.

k. Disconnect all test equipment.

36. Check X Gain

a. Change the following control settings:

CH 1 VOLTS/DIV	20 mV
MODE	CH 2
INT TRIG	CH 1 OR X-Y
B COUPLING	DC
HORIZ DISPLAY	X-Y
Horizontal POSITION	Centered
FINE	Centered

b. Connect the standard amplitude calibrator to the CH 1 OR X connector with the 42-inch BNC cable.

c. Set the standard amplitude calibrator for a 0.1-volt square-wave output.

d. Increase the INTENSITY control setting until the display is visible (two dots above five divisions apart).

e. Move the display to the center of the graticule with the Channel 1 POSITION control.

Performance Check—453A/R453A

f. CHECK—CRT display for five divisions ± 0.25 division of horizontal deflection.

g. CALIBRATION—See step 28 of Adjustment procedure.

37. Check X-Y Operation

a. Set the B SOURCE switch to EXT.

b. Connect the standard amplitude calibrator to the B EXT TRIG OR X INPUT connector.

c. Set the standard amplitude calibrator for a two-volt square-wave output.

d. Center the display (two dots) with the horizontal POSITION control.

e. CHECK—CRT display for horizontal deflection between 6.5 and 8.7 divisions (270 millivolts/division, $\pm 15\%$).

f. Set the standard amplitude calibrator for a 20-volt square-wave output.

g. Set the B SOURCE switch to EXT $\div 10$.

h. CHECK—CRT display for horizontal deflection between 6.2 and 9.2 divisions (2.7 volts/division, $\pm 20\%$).

i. Disconnect all test equipment.

38. Check X-Y Phasing

a. Connect the high-frequency sine-wave generator to the CH 1 OR X and CH 2 OR Y connectors with the five-nanosecond GR cable, in-line 50-ohm GR termination, and the dual-input coupler.

b. Set the B SOURCE switch to INT.

c. Set the generator for eight divisions of vertical and horizontal deflection at an output frequency of 50 kilohertz.

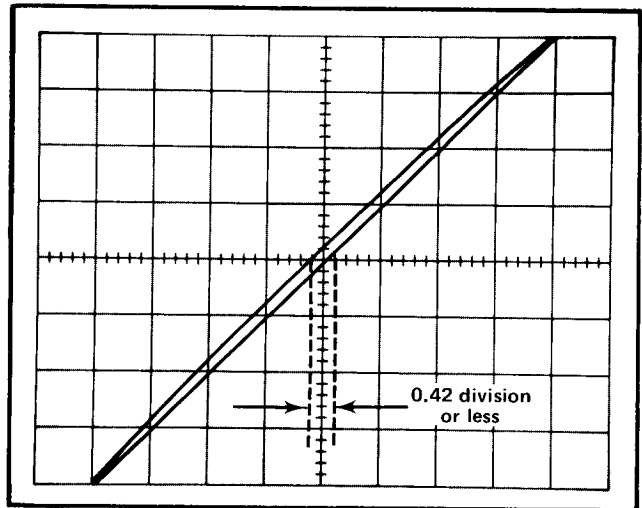


Fig. 5-1. Typical CRT display when checking X-Y phasing.

d. Center the display vertically and horizontally with the Channel 1 and 2 POSITION controls.

e. CHECK—CRT display for an opening at the center horizontal line of 0.42 division or less (3° or less phase shift; see Fig. 5-1).

f. Disconnect all test equipment.

39. Check X Bandwidth in X-Y Mode

a. Connect the high-frequency constant-amplitude sine-wave generator to the CH 1 OR X connector with the five-nanosecond GR cable and the in-line 50-ohm GR termination.

b. Set the generator for eight divisions horizontal deflection at its reference frequency (50 kilohertz).

c. Without changing the output amplitude, increase the output frequency of the generator until the horizontal deflection is reduced to 5.6 divisions (-3 dB point).

d. CHECK—Output frequency of generator must be five megahertz or higher. Actual frequency _____ megahertz.

e. Disconnect all test equipment.

OUTPUT SIGNALS CHECK

Equipment Required

1. Time-mark generator
2. Standard amplitude calibrator
3. Test-oscilloscope system
4. 18-inch 50-ohm BNC cable
5. 42-inch 50-ohm BNC cable
6. 50-ohm BNC termination
7. Current-measuring probe

Control Settings

Set the controls as given under Preliminary Control Settings.

40. Check Calibrator Repetition Rate

- a. Change the following control settings:

CH 1 and 2 VOLTS/DIV	.5
MODE	ALT
A TIME/DIV	.1 ms
CALIBRATOR	1 V

b. Connect the 1 kHz CAL connector to the CH 1 OR X connector with the 18-inch BNC cable.

c. Connect the time-mark generator to the CH 2 OR Y connector with the 42-inch 50-ohm BNC cable and the 50-ohm BNC termination.

d. Set the time-mark generator for one-millisecond markers.

e. Position the display vertically so the tips of the markers fall just below the rising portions of the square wave.

f. Set the A LEVEL control so both waveforms are stable.

g. Position the rising portion of the second calibrator cycle to the center vertical line.

h. Set the MAG switch to X10.

i. CHECK—Difference between calibrator waveform leading edge and the marker leading edge not to exceed 0.5 division (0.5% accuracy).

j. CALIBRATION—See step 6 of Adjustment procedure.

k. Disconnect all test equipment.

41. Check Calibrator Voltage Output

- a. Change the following control settings:

CH 1 VOLTS/DIV	.1
A SOURCE	LINE
A TIME/DIV	5 ms

b. Connect the 1 kHz CAL connector to the unknown input connector of the standard amplitude calibrator with the 42-inch BNC cable.

c. Set the standard amplitude calibrator for a positive one-volt DC output in the chopped mode.

d. Connect the standard amplitude calibrator output to the CH 1 OR X connector.

e. Set the A LEVEL control for a stable display.

f. Position the top of the waveform onto the display area with the Channel 1 POSITION control.

g. CHECK—Difference between the standard amplitude calibrator output level and the 453A calibrator output is 0.1 division or less (one volt output, $\pm 1\%$; see Fig. 5-2).

- h. Change the following control settings:

CH 1 VOLTS/DIV	10 mV
CALIBRATOR	.1 V

i. Set the standard amplitude calibrator for a positive, 0.1-volt DC output in the chopped mode.

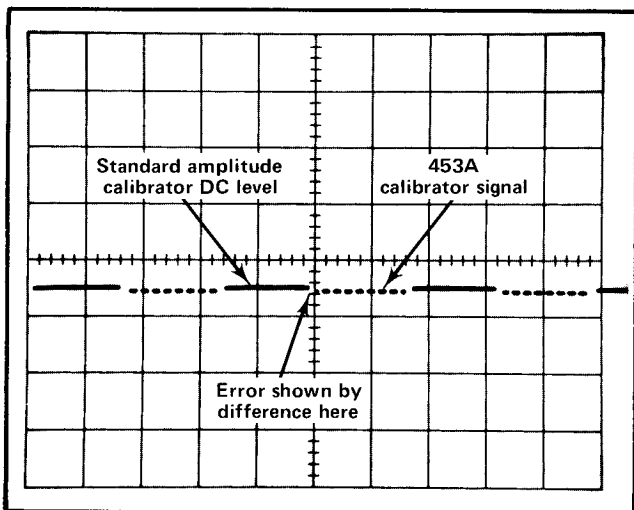


Fig. 5-2. Typical CRT display when checking voltage output of calibrator.

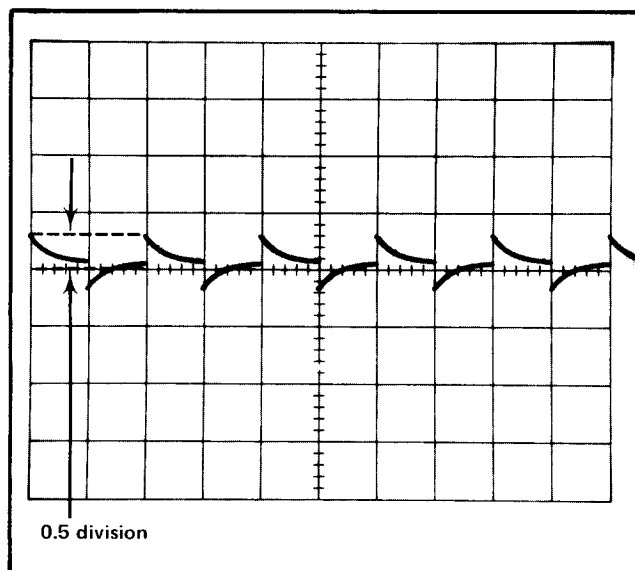


Fig. 5-3. Typical CRT display when checking calibrator current.

j. Position the top of the waveform onto the display area with the Channel 1 POSITION control.

k. CHECK—Difference between the standard amplitude calibrator output level and the 453A calibrator output is 0.1 division or less (0.1 volt output, $\pm 1\%$; see Fig. 5-2).

l. CALIBRATION—See step 2 of Adjustment procedure.

m. Disconnect all test equipment.

42. Check Current Through Probe Loop

a. Connect the current-measuring probe and passive termination to the CH 1 OR X connector.

b. Set the passive termination for a sensitivity of 2 mA/mV.

c. Clip the current-measuring probe around the PROBE LOOP on the side panel.

d. Change the following control settings:

CH 1 VOLTS/DIV	5 mV
A SOURCE	INT
A TIME/DIV	1 ms

e. CHECK—CRT display 0.5 division in amplitude (five milliamperes; see Fig. 5-3).

NOTE

This step only checks for the presence of current in the PROBE LOOP. This current will remain within the stated 1% accuracy due to the tolerance of the divider resistors and tolerance of the calibrator output voltage. If it is necessary to verify the accuracy of the calibrator current, use a current-measuring meter with an accuracy of at least 0.25%.

f. Disconnect all test equipment.

43. Check A and B Gate Output Signal

a. Set the A TIME/DIV switch to 1 ms. Be sure the A SWEEP LENGTH control is set to FULL.

b. Connect the A GATE connector (on side panel) to the test-oscilloscope with the 42-inch BNC cable.

c. Set the test oscilloscope for a vertical deflection factor of five volts/division at a sweep rate of two milliseconds/division.

d. CHECK—Test oscilloscope display for 2.4 divisions ± 0.24 division of vertical deflection with the bottom of the waveform near the zero-volt level (12 volts $\pm 10\%$). Gate duration should be about 5.5 divisions (about 11 times the A TIME/DIV switch setting).

PART II — ADJUSTMENT

Introduction

The following procedure returns the 453A to correct calibration. All limits and tolerances given in this procedure are calibration guides, and should not be interpreted as instrument specifications except as listed in the Performance Requirement column of Section 1. The actual operation of the instrument may exceed the given limits or tolerances if the instrument meets the Performance Requirements as checked in Part I — Performance Check of this section.

Index to Part II — Adjustment

POWER-SUPPLY and CALIBRATION ADJUSTMENT

- | | |
|---|-----------|
| 1. Adjust -12-Volt Power Supply (R1122) | Page 5-28 |
| 2. Adjust +12-Volt Power Supply (Adjust Calibrator Output Voltage) (R1152). | Page 5-28 |
| 3. Adjust +75-Volt Power Supply (R1182) | Page 5-29 |
| 4. Adjust High-Voltage Supply (R900) | Page 5-29 |
| 5. Check Low-Voltage Power Supply Ripple | Page 5-29 |
| 6. Adjust Calibrator Repetition Rate (T1255) | Page 5-30 |

DISPLAY and Z-AXIS ADJUSTMENT

- | | |
|--|-----------|
| 7. Adjust CRT Grid Bias (R940) | Page 5-31 |
| 8. Adjust Trace Alignment (TRACE ROTATION) | Page 5-31 |
| 9. Adjust Astigmatism (ASTIG) | Page 5-31 |
| 10. Adjust Y Axis Alignment (R989) | Page 5-31 |
| 11. Adjust CRT Geometry (R982) | Page 5-32 |
| 12. Adjust Z-Axis Compensation (C1036) | Page 5-32 |

Vertical System Adjustment

- | | |
|---|-----------|
| 13. Adjust Channel 1 and 2 Step Attenuator Balance (STEP ATTEN BAL) | Page 5-33 |
| 14. Adjust Channel 1 and 2 Position Center (R55, R155) | Page 5-33 |

- | | |
|--|-----------|
| 15. Adjust Channel 1 and 2 Gain (GAIN) | Page 5-34 |
|--|-----------|

- | | |
|---|-----------|
| 16. Adjust Channel 1 and 2 Volts/Division Switch Series Compensation (C6C, C7C, C8C, C9C, C106C, C107C, C108C, C109C) | Page 5-34 |
|---|-----------|

- | | |
|---|-----------|
| 17. Adjust Channel 1 and 2 Volts/Division Switch Shunt Compensation (C6B, C7B, C8B, C9B, C17, C106B, C107B, C108B, C109B, C117) | Page 5-35 |
|---|-----------|

- | | |
|--|-----------|
| 18. Adjust High-Frequency Compensation (C263, C265, R49, C49, R328, C336, C328, C54, C45A, R149, C149, C154, C154A, R144C, C144C, R143C, C143C, C143A, L143A, R43C, C43C, C43A, L43A, R44C, C44C,) | Page 5-36 |
|--|-----------|

TRIGGER SYSTEM ADJUSTMENT

- | | |
|---|-----------|
| 19. Adjust A and B Trigger Level Centering (R462, R662) | Page 5-40 |
| 20. Adjust Channel 1 Only and Normal Trigger DC Level (R60, R285) | Page 5-40 |

HORIZONTAL SYSTEM ADJUSTMENT

- | | |
|---|-----------|
| 21. Adjust Sweep Start and A Sweep Calibration (R531, R758) | Page 5-42 |
| 22. Adjust Normal Gain (R835) | Page 5-43 |
| 23. Adjust Magnified Gain (R845) | Page 5-43 |
| 24. Adjust Magnifier Register (R855) | Page 5-43 |
| 25. Adjust B Sweep Calibration (R741) | Page 5-44 |
| 26. Adjust A and B One-Microsecond Timing (C530A, C740A) | Page 5-44 |
| 27. Adjust High-Speed Linearity (C882, C892) | Page 5-44 |
| 28. Adjust X Gain (R645) | Page 5-45 |

Preliminary Procedure For Adjustment

NOTE

This instrument should be adjusted at an ambient temperature of 25°C ±5°C for best overall accuracy.

POWER-SUPPLY and CALIBRATOR ADJUSTMENT

Equipment Required

- | | |
|---------------------------|-----------------------------|
| 1. Autotransformer | 6. 18-inch 50-ohm BNC cable |
| 2. Precision DC voltmeter | 7. 42-inch 50-ohm BNC cable |
| 3. DC voltmeter (VOM) | 8. 50-ohm BNC termination |
| 4. Time-mark generator | 9. Three-inch screwdriver |
| 5. 1X probe | |

Control Settings

Set the controls as given under Preliminary Control Settings.

1. Adjust -12-Volt Power Supply

- a. Change the following control settings:

INTENSITY	Counterclockwise
A LEVEL	Clockwise
A SWEEP MODE	NORM TRIG
CALIBRATOR	1 V

- b. Connect the precision DC voltmeter between the -12-volt test point (see Fig. 5-4) and chassis ground.

- c. CHECK—Meter reading; -12 volts ± 0.32 volt.

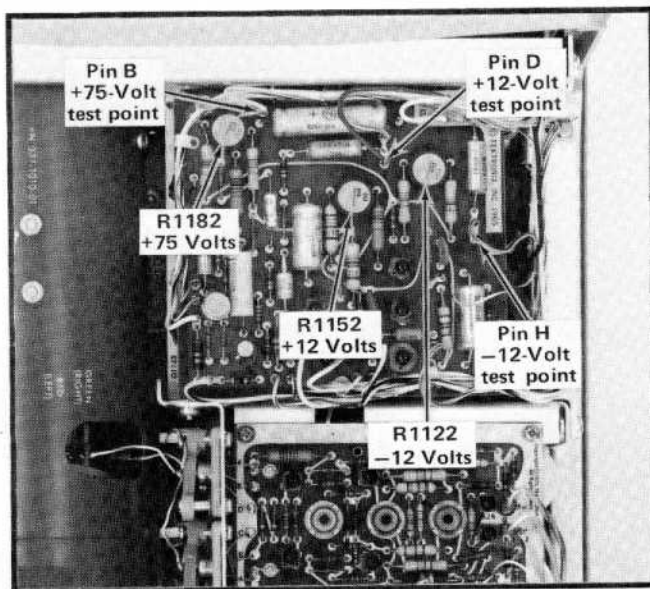


Fig. 5-4. Low-voltage power supply test points and adjustments (Low-Voltage Regulator circuit board).

- d. ADJUST— -12-Volts adjustment R1122 (see Fig. 5-4) for a meter reading of exactly -12 volts.

- e. INTERACTION—Change in setting of R1122 may affect operation of all circuits within the 453A.

2. Adjust +12-Volt Power Supply (Adjust Calibrator Output Voltage)

- a. Connect the precision DC voltmeter between the center contact of the 1 kHz CAL connector and chassis ground.

- b. Remove Q1255 (see Fig. 5-6) from its socket.

- c. CHECK—Meter reading; +1 volt ± 0.003 volt.

- d. ADJUST— +12 Volts adjustment R1152 (see Fig. 5-4) for a meter reading of exactly +1 volt.

- e. Set the CALIBRATOR switch (on side panel) to .1 V.

- f. CHECK—Meter reading; +0.1 volt ± 0.001 volt.

- g. ADJUST—If necessary, compromise the setting of R1152 for correct calibrator output for both checks c and f.

- h. Replace Q1255 in its socket.

- i. Connect the precision DC voltmeter between the +12-volt test point (see Fig. 5-4) and chassis ground.

j. CHECK—Meter reading; +12.1 volts \pm 0.12 volt.

k. INTERACTION—Change in setting of R1152 may affect operation of all circuits within the 453A.

3. Adjust +75-Volt Power Supply

a. Connect the precision DC voltmeter between the +75-volt test point (see Fig. 5-4) and chassis ground.

b. CHECK—Meter reading; +75 volts \pm 0.278 volt.

c. ADJUST— +75 Volts adjustment R1182 (see Fig. 5-4) for a meter reading of exactly +75 volts.

d. Recheck the -12-Volt and +12-Volt supplies; readjust if necessary.

e. INTERACTION—Change in setting of R1182 may affect operation of all circuits within the 453A.

f. Disconnect all test equipment.

4. Adjust High-Voltage Supply

a. Connect the DC voltmeter (VOM)⁴ between the -1960 V test point (see Fig. 5-5) and chassis ground.

⁴If the precision high-voltage divider is available for use with the precision DC voltmeter, it should be used for this step.

b. CHECK—Meter reading; -1960 volts \pm 58.8 volts.

c. ADJUST—High Voltage adjustment R900 (see Fig. 5-5) for -1960 volts.

d. INTERACTION—Change in setting of R900 may affect operation of all circuits within the 453A.

e. Disconnect all test equipment.

5. Check Low-Voltage Power Supply Ripple

a. Connect the 1X probe to the CH 1 OR X connector.

b. Change the following control settings:

INTENSITY	Midrange
A LEVEL	Midrange
A SWEEP MODE	AUTO TRIG

c. Connect the probe tip to the 1 kHz CAL connector.

d. Set the Channel 1 GAIN adjustment for exactly four divisions of vertical deflection (preliminary adjustment to assure accurate ripple measurement).

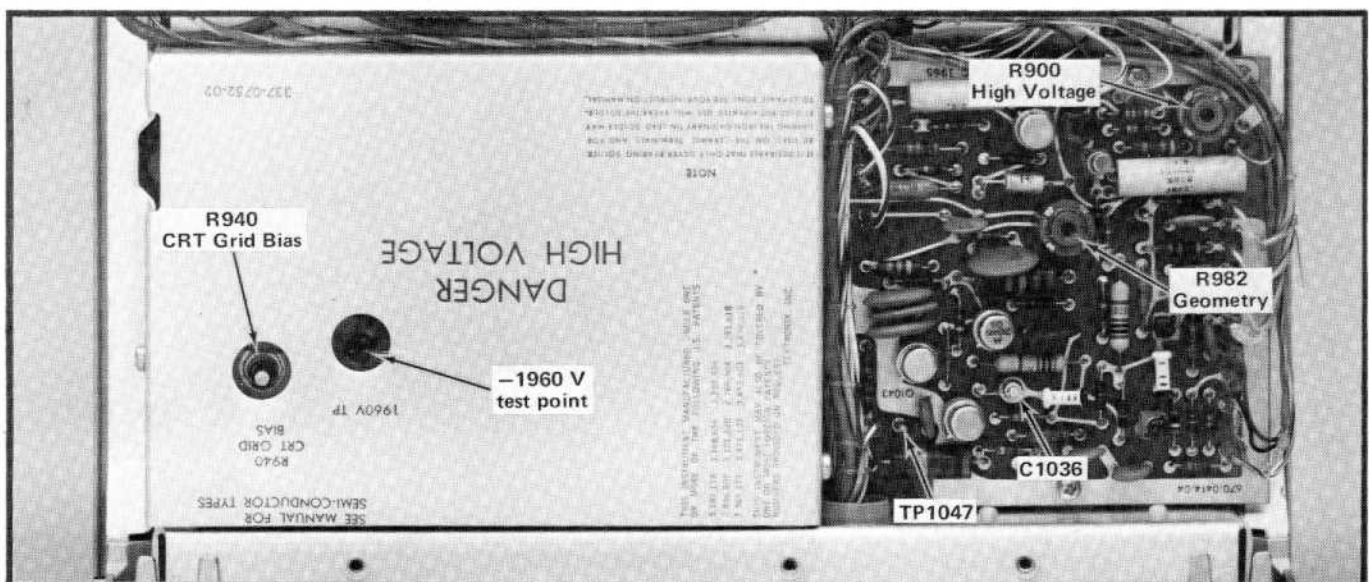


Fig. 5-5. Location of high-voltage and Z-axis test points and adjustments (bottom of instrument).

Adjustment—453A/R453A

e. Change the following control settings:

CH 1 VOLTS/DIV	5 mV
Channel 1 Input Coupling	AC
A SOURCE	LINE
A TIME/DIV	5 ms

f. CHECK—0.4 division maximum peak-to-peak (two millivolts) line frequency ripple on the -12-Volt, +12-Volt, and +75-Volt supplies while changing the autotransformer output voltage throughout the regulating range selected by the Line Voltage Selector assembly on the rear panel. Power-supply test points are shown in Fig. 5-4.

NOTE

Ripple tolerances are provided as guides to correct instrument operation. Actual values may exceed these limits without loss of measurement accuracy if the instrument meets the specifications given in Section 1.

g. Return the autotransformer output voltage to the center of the regulating range selected by the Line Voltage Selector assembly. (If the line voltage is near the center of the regulating range, the 453A can be connected directly to the line for the remainder of this procedure.)

h. Disconnect all test equipment.

6. Adjust Calibrator Repetition Rate

a. Change the following control settings:

CH 1 VOLTS/DIV	50 mV
CH 2 VOLTS/DIV	.5
MODE	ALT
A SOURCE	INT
A TIME/DIV	.5 ms

b. Connect the 1 kHz CAL connector to the CH 1 OR X connector with the 18-inch BNC cable.

c. Connect the time-mark generator to the CH 2 OR Y connector with the 42-inch 50-ohm BNC cable and the 50-ohm BNC termination.

d. Set the time-mark generator for one-millisecond markers.

e. Position the display so the tips of the markers fall just below the rising portions of the square wave.

f. Set the A LEVEL control so both waveforms are stable.

g. CHECK—CRT display for one cycle of calibrator waveform for each marker.

h. ADJUST—Calibrator Frequency adjustment T1255 (see Fig. 5-6) for one cycle of calibrator waveform for each marker (preliminary adjustment).

i. Set the INT TRIG switch to CH 1 OR X-Y.

j. CHECK—CRT display for slow drift or no drift of the time markers.

k. ADJUST—T1255 for minimum drift of the time markers (final adjustment).

l. Disconnect all test equipment.

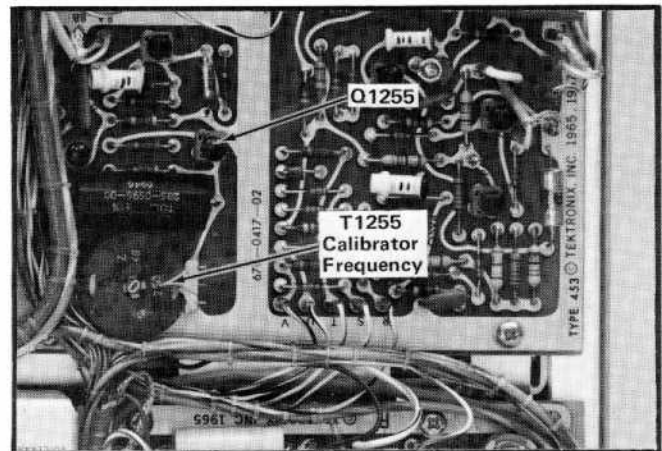


Fig. 5-6. Location of calibrator adjustments.

DISPLAY and Z-AXIS ADJUSTMENT

Equipment Required

1. DC voltmeter (VOM)
2. Time-mark generator
3. Test-oscilloscope system
4. 18-inch 50-ohm BNC cable
5. 42-inch 50-ohm BNC cable
6. Three-inch screwdriver
7. Low-capacitance screwdriver

Control Settings

Set the controls as given under Preliminary Control Settings.

7. Adjust CRT Grid Bias

- a. Connect the DC voltmeter (VOM) between TP1047 (see Fig. 5-5) and chassis ground.
- b. Set the A SWEEP MODE switch to SINGLE SWEEP.
- c. Set the INTENSITY control for a meter reading of +12 volts.
- d. ADJUST—CRT Grid Bias adjustment R940 (see Fig. 5-5) so the dot on the CRT is just extinguished (it may be necessary to turn the horizontal POSITION control clockwise to bring the dot onto the viewing area).

CAUTION

Do not allow a bright spot to remain stationary for an extended period, as it may burn the CRT phosphor.

- e. Disconnect all test equipment.

8. Adjust Trace Alignment

- a. Set the A SWEEP MODE switch to AUTO TRIG.
- b. Set the INTENSITY control for a visible trace.

- c. Move the trace to the center horizontal line with the Channel 1 POSITION control.

- d. Set the FOCUS control for as thin a trace as possible.

- e. CHECK—The trace should be parallel with the center horizontal line.

- f. ADJUST—TRACE ROTATION adjustment (side panel) so the trace is parallel to the center horizontal line.

9. Adjust Astigmatism

- a. Connect the time-mark generator to the CH 1 OR X connector with the 18-inch BNC cable.
- b. Set the time-mark generator for one-millisecond markers.

- c. Change the following control settings:

CH 1 VOLTS/DIV	.5
A LEVEL	Stable display

- d. CHECK—Markers are well defined with optimum setting of the FOCUS control.

- e. ADJUST—FOCUS control and ASTIG adjustment (side panel) for best definition of the markers.

10. Adjust Y Axis Alignment

- a. Change the following control settings:

CH 1 VOLTS/DIV	50 mV
Channel 1 POSITION	Counterclockwise

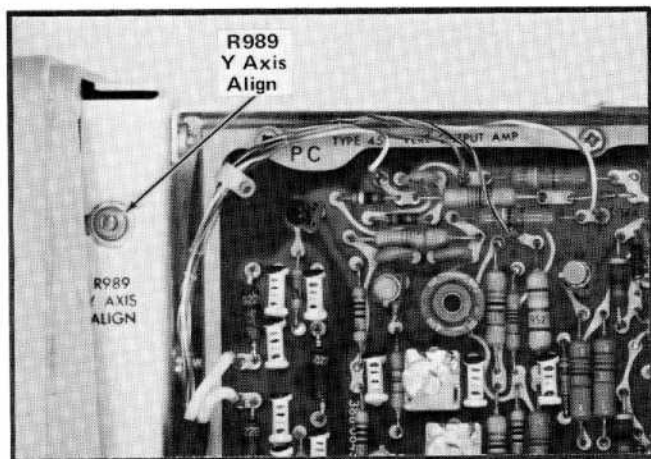


Fig. 5-7. Location of Y Axis Align adjustment (left side of instrument).

b. Move a marker to the center vertical line with the horizontal POSITION control.

c. Marker aligns with center vertical line within 0.1 division total from top to bottom of the graticule.

d. ADJUST—Y Axis Align adjustment R989 (see Fig. 5-7) to align the markers with the center vertical line.

11. Adjust CRT Geometry

a. Set the A TIME/DIV switch to .5 ms and adjust the A VAR control to display exactly one marker for each major graticule division.

b. Connect the trigger output of the time-mark generator to the A EXT TRIG INPUT connector with the 42-inch BNC cable.

c. Set the time-mark generator for marker output of one and 0.1 millisecond and trigger output of one millisecond.

d. Set the A SOURCE switch to EXT. If necessary, adjust the A LEVEL control to provide a stable display.

e. CHECK—Bowling and tilt of markers is less than 0.1 division total from top to bottom of the graticule (each 0.1-millisecond marker represents 0.1 division).

f. ADJUST—Geometry adjustment R982 (see Fig. 5-5) for minimum bowing of the trace at the left and right edges of the graticule.

g. INTERACTION—Recheck step 10.

h. Disconnect all test equipment.

12. Adjust Z-Axis Compensation

a. Change the following control settings:

A SOURCE	INT
A TIME/DIV	.1 μ s
A VAR	Calibrated

b. Connect the 10X probe to the input of the test oscilloscope. Check the probe compensation.

c. Connect the probe tip to TP1047 (see Fig. 5-5); connect the probe ground to chassis ground with a short grounding strap.

d. Set the test oscilloscope for a vertical deflection factor of 0.5 volts/division (five volts/division at probe tip) at a sweep rate of 0.1 microsecond/division.

e. Set the INTENSITY control for three divisions of vertical deflection on the test oscilloscope. Position the display so the leading edge of the waveform is displayed.

f. CHECK—Test oscilloscope display for optimum square leading corner on unblanking gate.

g. ADJUST—C1036 (see Fig. 5-5) for optimum square corner on the unblanking gate.

h. Disconnect all test equipment.

VERTICAL SYSTEM ADJUSTMENT

Equipment Required

- | | |
|----------------------------------|----------------------------------|
| 1. DC voltmeter (VOM) | 7. 5X GR attenuator |
| 2. Standard amplitude calibrator | 8. In-line 50-ohm GR termination |
| 3. Square-wave generator | 9. 20-pF input normalizer |
| 4. 42-inch 50-ohm BNC cable | 10. Three-inch screwdriver |
| 5. Dual-input coupler | 11. Low-capacitance screwdriver |
| 6. Five-nanosecond GR cable | 12. Tuning tool |

Control Settings

Set the controls as given under Preliminary Control Settings.

13. Adjust Channel 1 and 2 Step Attenuator Balance

a. Set the Channel 1 and 2 Input Coupling switches to GND.

b. Position the trace to the center horizontal line with the Channel 1 POSITION control.

c. CHECK—Change the CH 1 VOLTS/DIV switch from 20 mV to 5 mV. Trace should not move more than 0.1 division vertically.

NOTE

Use the BEAM FINDER switch to locate the trace if it is deflected off screen when switching to 10 or 5 mV.

d. ADJUST—Channel 1 STEP ATTEN BAL adjustment (front panel) for minimum trace shift as the CH 1 VOLTS/DIV switch is changed from 20 mV to 5 mV.

e. Set the MODE switch to CH 2.

f. Position the trace to the center horizontal line with the Channel 2 POSITION control.

g. CHECK—Change the CH 2 VOLTS/DIV switch from 20 mV to 5 mV. Trace should not move more than 0.1 division vertically.

h. ADJUST—Channel 2 STEP ATTEN BAL adjustment (front panel) for minimum trace shift as the CH 2 VOLTS/DIV switch is changed from 20 mV to 5 mV.

14. Adjust Channel 1 and 2 Position Center

a. Connect the DC voltmeter between pin connector "Z" on the Vertical Preamp board (see Fig. 5-8) and chassis ground.

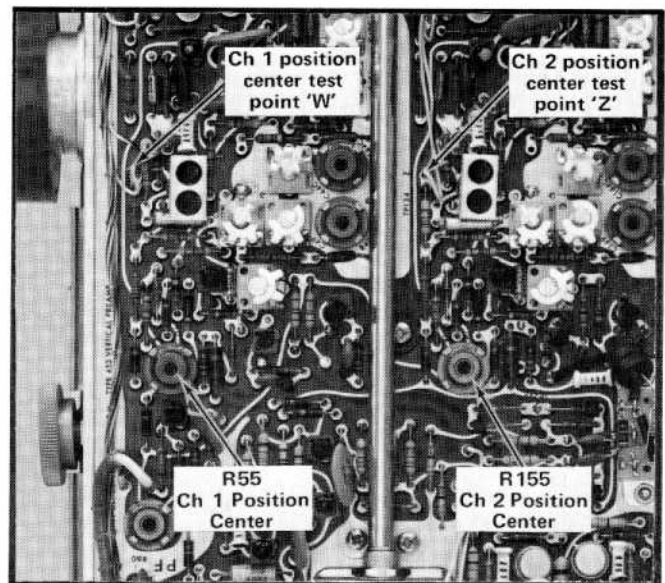


Fig. 5-8. Location of position center test points and adjustments (Vertical Preamp board).

Adjustment—453A/R453A

b. Set the Channel 2 POSITION control for a meter reading of zero volts. (The dot on the Channel 2 POSITION control should be centered; if not, loosen the set screw and mechanically reposition the knob.)

c. CHECK—Trace within one division of the center horizontal line.

d. ADJUST—CH 2 Position Center adjustment R155 (see Fig. 5-8) to position the trace to the center line.

e. Set the MODE switch to CH 1.

f. Connect the DC voltmeter between pin connector "W" on the Vertical Preamp board (see Fig. 5-8) and chassis ground.

g. Set the Channel 1 POSITION control for a meter reading of zero volts. (The dot on the Channel 1 POSITION control should be centered; if not, loosen the set screw and mechanically reposition the knob.)

h. CHECK—Trace within one division of the center horizontal line.

i. ADJUST—CH 1 Position Center adjustment R55 (see Fig. 5-8) to position the trace to the center line.

j. INTERACTION—Re-check step 13.

k. Disconnect all test equipment.

15. Adjust Channel 1 and 2 Gain

a. Change the following control settings:

CH 1 and 2 VOLTS/DIV	20 mV
Channel 1 and 2 Input	DC
Coupling	
A TIME/DIV	.5 ms

b. Connect the standard amplitude calibrator to the CH 1 OR X and CH 2 OR Y connectors with the 42-inch BNC cable and the dual-input coupler.

c. Set the standard amplitude calibrator for a 0.1-volt square-wave output.

d. Position the display to the center of the graticule with the Channel 1 POSITION control.

e. CHECK—CRT display exactly five divisions in amplitude.

f. ADJUST—Channel 1 GAIN adjustment (front panel) for exactly five divisions of deflection.

g. Change the following control settings:

MODE	ADD
INVERT	Pulled out

h. CHECK—CRT display for straight line.

i. ADJUST—Channel 2 GAIN adjustment (front panel) for straight line display.

j. Disconnect all test equipment.

16. Adjust Channel 1 and 2 Volts/Division Switch Series Compensation

a. Change the following control settings:

CH 1 and 2 VOLTS/DIV	50 mV
MODE	CH 1
INVERT	Pushed in
A TIME/DIV	.2 ms

b. Connect the square-wave generator high-amplitude output connector to the CH 1 OR X connector with the five-nanosecond GR cable, 5X GR attenuator, and 50-ohm in-line termination in given order.

c. Set the square-wave generator for six divisions of one-kilohertz signal.

d. Set the A LEVEL control for a stable display.

e. CHECK—CRT display at each CH 1 VOLTS/DIV switch position listed in Table 5-5 for square corner within 0.12 division. Readjust the generator output at each switch position to provide six divisions of deflection.

f. ADJUST—CH 1 VOLTS/DIV switch series compensation as given in Table 5-5 for optimum square corner on the

TABLE 5-5
CH 1 and 2 VOLTS/DIV Series Compensation

CH 1 and 2 VOLTS/DIV switch setting	Channel 1 series compensation	Channel 2 series compensation
50 mV	C6C	C106C
.1	C7C	C107C
.2	C8C	C108C
Remove 5X attenuator		
2	C9C	C109C

displayed waveform (use low-capacitance screwdriver). Readjust the generator output at each switch position to provide six divisions of deflection. Fig. 5-9 shows the location of the capacitors.

g. Disconnect the termination from Channel 1 and connect the signal to the CH 2 OR Y connector with the five-nanosecond GR cable, 5X GR attenuator, and in-line 50-ohm GR termination.

h. Set the MODE switch to CH 2.

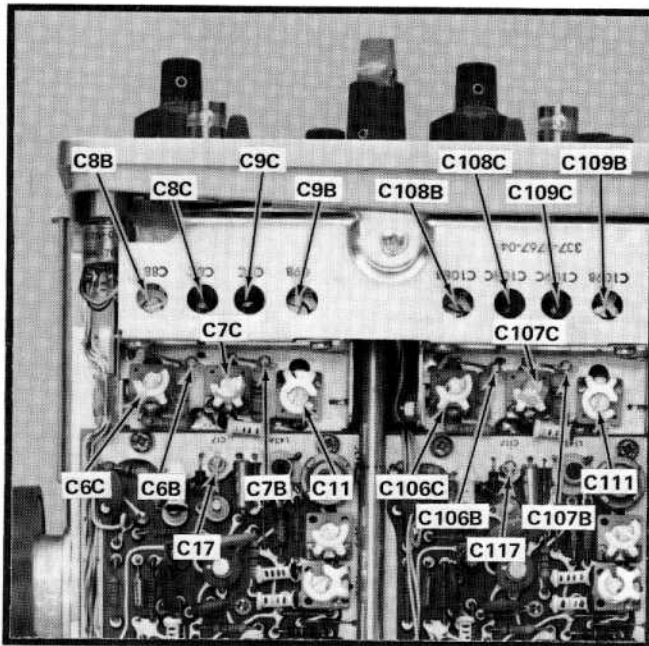


Fig. 5-9. Location of CH 1 and 2 VOLTS/DIV switch compensation.

i. CHECK—CRT display at each CH 2 VOLTS/DIV switch position listed in Table 5-5 for square corner within 0.12 division. Readjust the generator output at each switch position to provide six divisions of deflection.

j. ADJUST—CH 2 VOLTS/DIV switch series compensation as given in Table 5-5 for optimum square corner on the displayed waveform (use low-capacitance screwdriver). Readjust the generator output at each switch position to provide six divisions of deflection. Fig. 5-9 shows the location of the capacitors.

k. Disconnect all test equipment.

17. Adjust Channel 1 and 2 Volts/Division Switch Shunt Compensation

a. Connect the square-wave generator high-amplitude output connector to the CH 2 OR Y connector with the five-nanosecond GR cable, 5X GR attenuator, in-line 50-ohm GR termination, and 20 pF input RC normalizer, in given order.

b. Set the CH 2 VOLTS/DIV switch to 20 mV.

c. Set the square-wave generator for six divisions of one-kilohertz signal.

d. CHECK—CRT display at each CH 2 VOLTS/DIV switch position listed in Table 5-6 for square corner within 0.12 division. Readjust the generator output at each switch position to provide six divisions of deflection.

TABLE 5-6
CH 1 and 2 VOLTS/DIV Shunt Compensation

CH 1 and 2 VOLTS/DIV switch setting	Channel 1 shunt compensation	Channel 2 shunt compensation
20 mV	C17	C117
50 mV	C6B	C106B
.1	C7B	C107B
.2	C8B	C108B
Remove 5X attenuator		
.5	Adjust C11 for best compromise	Adjust C111 for best compromise
1		
2	C9B	C109B

Adjustment—453A/R453A

e. ADJUST—CH 2 VOLTS/DIV switch shunt compensation as given in Table 5-6 for optimum square corner on the displayed waveform (use low-capacitance screwdriver). Readjust the generator output at each switch position to provide six divisions of deflection (maximum of about three divisions obtainable in the 2 position). Fig. 5-9 shows the location of the capacitors.

f. Disconnect the normalizer from Channel 2 and connect the signal to the CH 1 OR X connector with the five-nanosecond GR cable, 5X GR attenuator, in-line 50-ohm GR termination, and 20 pF input RC normalizer, in given order.

g. Set the MODE switch to CH 1.

h. CHECK—CRT display at each CH 1 VOLTS/DIV switch position listed in Table 5-6 for square corner within 0.12 division. Readjust the generator output at each switch position to provide six divisions of deflection.

i. ADJUST—CH 1 VOLTS/DIV switch shunt compensation as given in Table 5-6 for optimum square corner on the displayed waveform (use low-capacitance screwdriver).

Readjust the generator output at each switch position to provide six divisions of deflection (maximum of about three divisions obtainable in the 2 position). Fig. 5-9 shows the location of the capacitors.

j. Disconnect all test equipment.

18. Adjust High-Frequency Compensation

SELECTED COMPONENTS

The Vertical Preamp circuit board has four selected components which provide high-frequency compensation for the Vertical Deflection System. It should not be necessary to re-select these components unless the devices for which they compensate have been changed. Use Table 5-7 to select these components. If more than one component needs to be selected, select the components in the order given in this table. The location of each selected component is shown in Fig. 5-10. Table 5-7 lists the range of component values which provide correct compensation.

TABLE 5-7
Selected Components

Selected component	Range of values (to provide a 2 to 3% total compensating effect)	Device(s) for which this provides a compensating effect	Conditions for selecting (20 mV/Div, four-division 100 kHz signal applied)	Selection procedure
1. C38	.001 to .01 μ F	Q23, Q33	MODE CH 1 10 μ s/DIV MAG OFF	Select for best flat top over first 2 to 5 microseconds
2. C44A	0 to 4.7 pF	Feedback Amplifier	MODE CH 1 .1 μ s/Div MAG OFF	Select to match 10 mV response to 20 mV.
3. C264	14 to 47 pF	Delay line	MODE CH 1 2 μ s/DIV MAG OFF	Select for best flat top over first 0.2 to 0.6 microsecond
4. C138	.001 to .01 μ F	Q123, Q133	MODE CH 2 10 μ s/DIV MAG OFF	Select for best flat top over first 2 to 5 microseconds
5. C144A	0 to 4.7 pF	Feedback Amplifier	MODE CH 2 .1 μ s/DIV MAG OFF	Select to match 10 mV response to 20 mV
6. R195	24 k to 300 k Ω	Q84, Q94, Q184, Q194	MODE CH 2 2 μ s/DIV MAG OFF	Select for best match of Channel 2 to Channel 1 over first 0.5 microsecond

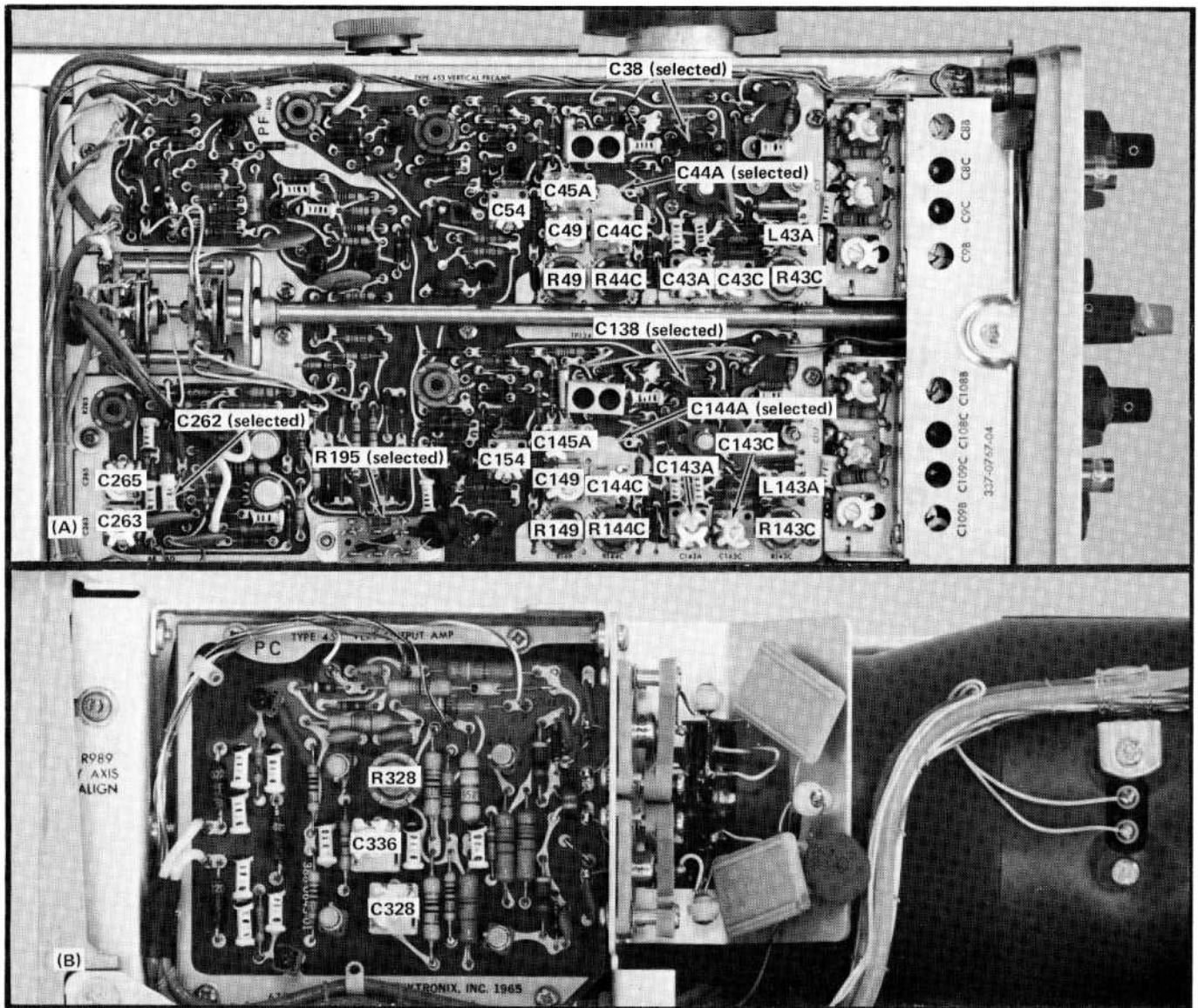


Fig. 5-10. (A) Location of high-frequency compensation adjustments on Vertical Preamp board, (B) Location of high-frequency compensation adjustments on Vertical Output board.

C38 and C138 are selected from among the following capacitors.

.001 μF	283-0067-00	200 V	$\pm 10\%$	1.5 pF	281-0529-00	500 V	± 0.25 pF
.0015 μF	283-0114-00	200 V	$\pm 20\%$	2.2 pF	281-0604-00	500 V	± 0.25 pF
.0022 μF	283-0119-00	200 V	$\pm 5\%$	3.3 pF	281-0626-00	500 V	$\pm 5\%$
.0027 μF	283-0142-00	200 V	$\pm 5\%$	4.7 pF	281-0618-00	200 V	± 0.5 pF
.0033 μF	283-0041-00	500 V	$\pm 5\%$	C264 is selected from among the following capacitors.			
.0047 μF	283-0083-00	500 V	$\pm 5\%$	14 pF	281-0577-00	500 V	$\pm 5\%$
.01 μF	283-0079-00	250 V	$\pm 20\%$	18 pF	281-0578-00	500 V	$\pm 5\%$
C44A and C144A are selected from among the following capacitors.				22 pF	281-0511-00	500 V	± 2.2 pF
0.68 pF	281-0537-00	500 V	± 0.136 pF	27 pF	281-0512-00	500 V	± 2.7 pF
1 pF	281-0627-00	600 V		33 pF	281-0629-00	600 V	$\pm 5\%$
				39 pF	281-0603-00	500 V	$\pm 5\%$
				47 pF	281-0519-00	500 V	± 4.7 pF

Adjustment—453A/R453A

- a. Change the following control settings:

CH 1 and 2 VOLTS/DIV	20 mV
A TIME/DIV	.5 μ s

b. Connect the fast-rise + output of the square-wave generator to the CH 1 OR X connector with the five-nanosecond GR cable, 5X GR attenuator, and in-line 50-ohm GR termination.

c. Set the square-wave generator for fast-rise operation at 100 kilohertz. Set the output amplitude for a six-division display.

d. CHECK—CRT display for optimum square-wave response with aberrations not to exceed 0.12 division peak to peak.

NOTE

Use a viewing hood or reduce the ambient light level to aid in checking high-frequency response.

e. ADJUST—C263 and C265 (see Fig. 5-10A) for optimum square-wave response with minimum aberrations. Use low-capacitance screwdriver.

f. Move the leading edge of the waveform to the vertical center line with the horizontal POSITION control.

- g. Change the following control settings:

A TIME/DIV	.2 μ s
MAG	X10

h. CHECK—CRT display for optimum square-wave response with aberrations not to exceed 0.12 division peak to peak.

NOTE

In the following steps, change the MAG switch from X10 to OFF and compare the response at both sweep rates. Then adjust for the best overall response.

i. ADJUST—R49, C49, R328, C336, C328, C54, and C45A (see Fig. 5-10), in given order, for optimum

square-wave response with minimum aberrations. Use the low-capacitance screwdriver to adjust the variable capacitors. Repeat these adjustments until optimum response is obtained.

- j. Set the MODE switch to CH 2.

k. Disconnect the termination from Channel 1 and connect it to the CH 2 OR Y connector.

l. CHECK—CRT display for optimum square-wave response with aberrations not to exceed 0.12 division peak to peak.

m. ADJUST—R149, C149, C154, and C145A (see Fig. 5-10A), in given order, for optimum square-wave response with minimum aberrations. Use the low-capacitance screwdriver to adjust the variable capacitors. Repeat these adjustments until optimum response is obtained. Final results of this adjustment should produce similar response for Channels 1 and 2.

NOTE

If response of Channel 1 and 2 cannot be matched by making the adjustments given here, see the procedure for selecting R195 given in Table 5-7.

- n. Set the CH 2 VOLTS/DIV switch to 10 mV.

o. Set the square-wave generator for a six-division display.

p. CHECK—CRT display for optimum square-wave response with aberrations not to exceed 0.12 division peak to peak.

q. ADJUST—R144C and C144C (see Fig. 5-10A), in given order, for optimum square-wave response. Use the low-capacitance screwdriver to adjust the variable capacitors. Repeat these adjustments until optimum response is obtained.

- r. Set the CH 2 VOLTS/DIV switch to 5 mV.

s. Set the square-wave generator for a six-division display.

t. CHECK—CRT display for optimum square-wave response with aberrations not to exceed 0.12 division peak to peak.

u. ADJUST—R143C, C143C, C143A, and L143A (see Fig. 5-10A), in given order, for optimum square-wave response with minimum aberrations. Use the low-capacitance screwdriver to adjust the variable capacitors. Repeat these adjustment until optimum response is obtained.

v. Change the following control settings:

CH 1 VOLTS/DIV	5 mV
MODE	CH 1

w. Disconnect the termination from Channel 2 and connect it to the CH 1 OR X connector.

x. CHECK—CRT display for optimum square-wave response with aberrations not to exceed 0.12 division peak to peak.

y. ADJUST—R43C, C43C, C43A, and L43A (see Fig. 5-10A), in given order, for optimum square-wave response with minimum aberrations. Use the low-capacitance screwdriver to adjust the variable capacitors. Repeat these adjustments until optimum response is obtained.

z. Set the CH 1 VOLTS/DIV switch to 10 mV.

aa. Set the square-wave generator for a six-division display.

ab. CHECK—CRT display for optimum square-wave response with aberrations not to exceed 0.12 division peak to peak.

ac. ADJUST—R44C and C44C (see Fig. 5-10A), in given order, for optimum square-wave response with minimum aberrations. Use the low-capacitance screwdriver to adjust the variable capacitors. Repeat these adjustments until optimum response is obtained.

ad. Disconnect all test equipment.

NOTES

TRIGGER SYSTEM ADJUSTMENT

Equipment Required

- | | |
|---------------------------------------|----------------------------------|
| 1. High-Frequency sine-wave generator | 3. In-line 50-ohm GR termination |
| 2. Five-nanosecond GR cable | 4. Three-inch screwdriver |

Control Settings

Set the controls as given under Preliminary Control Settings.

19. Adjust A and B Trigger Level Centering

- a. Change the following control settings:

CH 1 VOLTS/DIV	50 mV
A TIME/DIV	20 μ s
A SWEEP MODE	NORM TRIG

b. Connect the high-frequency sine-wave generator to the CH 1 OR X connector with the five-nanosecond GR cable and the in-line 50-ohm GR termination.

c. Set the generator for a 0.3-division display at 50 kilohertz (if necessary, use the AUTO TRIG position to obtain a 0.3-division display).

- d. Set the A LEVEL control to 0.

e. CHECK—Stable CRT display is presented.

f. ADJUST—A Trigger Level Center adjustment R462 (see Fig. 5-11) for a stable display.

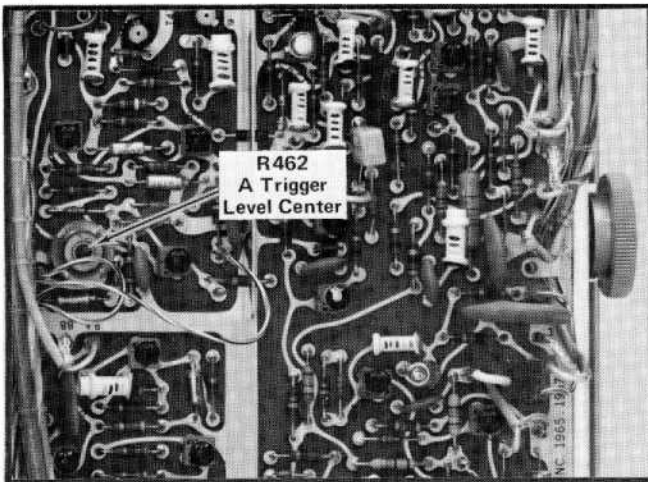


Fig. 5-11. Location of A Triggering adjustment (A sweep board).

- g. Change the following control settings:

A LEVEL	Stable display
B LEVEL	0
HORIZ DISPLAY	B (DELAYED SWEEP)

- h. CHECK—Stable CRT display is presented.

i. ADJUST—B Trigger Level Center adjustment R662 (see Fig. 5-13) for a stable display.

20. Adjust Channel 1 Only and Normal Trigger DC Level

- a. Change the following control settings:

INT TRIG	CH 1 OR X-Y
A COUPLING	DC
A SWEEP MODE	AUTO TRIG
HORIZ DISPLAY	A

b. Center the display about the center horizontal line with the Channel 1 POSITION control.

- c. CHECK—Stable CRT display is presented.

d. ADJUST—Channel 1 Trigger DC Level adjustment R60 (see Fig. 5-12) for a stable display.

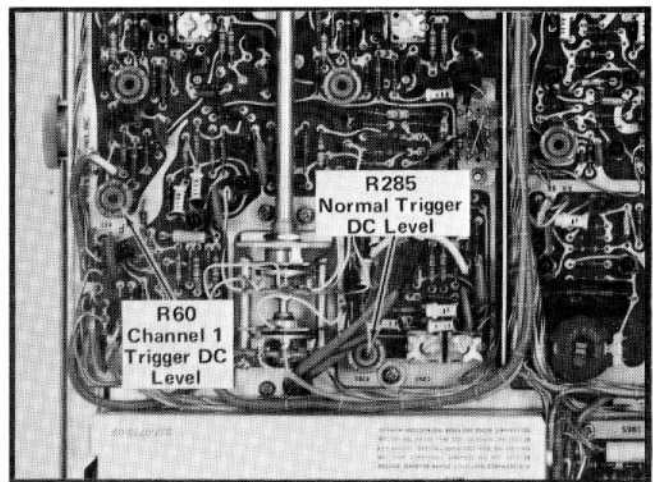


Fig. 5-12. Location of Triggering DC level adjustments (Vertical Preamp board).

e. Set the INT TRIG switch to NORM.

g. ADJUST—Normal Trigger DC Level adjustment R285 (see Fig. 5-12) for a stable display.

f. CHECK—Stable CRT display is presented.

h. Disconnect all test equipment.

NOTES

Lined area for notes.

HORIZONTAL SYSTEM ADJUSTMENT

Equipment Required

- | | |
|----------------------------------|--------------------------------|
| 1. Time-mark generator | 4. 50-ohm BNC termination |
| 2. Standard amplitude calibrator | 5. Three-inch screwdriver |
| 3. 42-inch 50-ohm BNC cable | 6. Low-capacitance screwdriver |

Control Settings

Set the controls as given under Preliminary Control Settings.

21. Adjust Sweep Start and A Sweep Calibration

a. Connect the time-mark generator to the CH 1 OR X connector with the 42-inch 50-ohm BNC cable and the 50-ohm BNC termination.

b. Change the following control settings:

CH 1 VOLTS/DIV	.5
B TIME/DIV	5 μ s
B SWEEP MODE	B STARTS AFTER DELAY TIME
HORIZ DISPLAY	A INTEN DURING B

c. Turn the DELAY-TIME MULTIPLIER dial fully counterclockwise.

d. CHECK—DELAY-TIME MULTIPLIER dial setting exactly 0.20.

e. ADJUST—If the DELAY-TIME MULTIPLIER dial is not correctly positioned when fully counterclockwise, loosen the set screw and mechanically reposition the dial to 0.20.

f. Repeat parts c through e until the DELAY-TIME MULTIPLIER dial is correctly positioned when fully counterclockwise.

g. Set the time-mark generator for one-millisecond markers.

h. Set the DELAY-TIME MULTIPLIER dial to 1.00.

i. CHECK—Intensified portion of display starts at second marker.

j. ADJUST—Sweep Start adjustment R758 (see Fig. 5-13) so intensified portion starts at second marker (preliminary adjustment).

k. Set the DELAY-TIME MULTIPLIER dial to 9.00.

l. CHECK—Intensified portion of display starts at tenth marker.

m. ADJUST—A Sweep Cal adjustment R531 (see Fig. 5-13) so intensified portion starts at tenth marker (preliminary adjustment).

n. Set the HORIZ DISPLAY switch to B (DELAYED SWEEP).

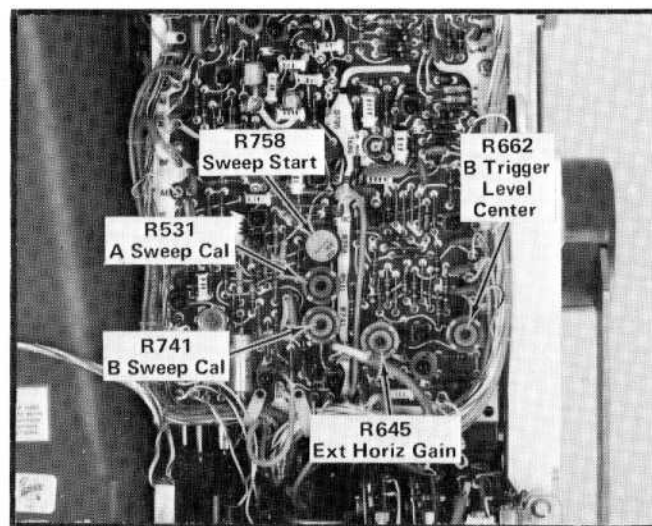


Fig. 5-13. Location of B Triggering and B Sweep Adjustments (B Sweep board).

o. Set the DELAY-TIME MULTIPLIER dial to exactly 1.00.

p. CHECK—Displayed pulse starts at the beginning of the sweep.

q. ADJUST—Sweep Start adjustment R758 (see Fig. 5-13) so displayed pulse starts at the beginning of the sweep.

r. Set the DELAY-TIME MULTIPLIER dial to exactly 9.00.

s. CHECK—Displayed pulse starts at the beginning of the sweep.

t. ADJUST—A Sweep Cal adjustment R531 (see Fig. 5-13) so displayed pulse starts at the beginning of the sweep.

u. Repeat parts o through t and readjust if necessary.

22. Adjust Normal Gain

a. Set the HORIZ DISPLAY switch to A.

b. CHECK—CRT display for one marker each division between the first and ninth graticule lines.

NOTE

Unless otherwise noted, use the middle eight horizontal divisions when checking or adjusting timing.

c. ADJUST—Normal Gain adjustment R835 (see Fig. 5-14) for one marker each division. The second and tenth markers must coincide exactly with their respective graticule lines (reposition display slightly with the horizontal POSITION control if necessary).

d. INTERACTION—Check steps 23-28.

23. Adjust Magnified Gain

a. Set the time-mark generator for 0.1 millisecond markers.

b. Set the MAG switch to X10.

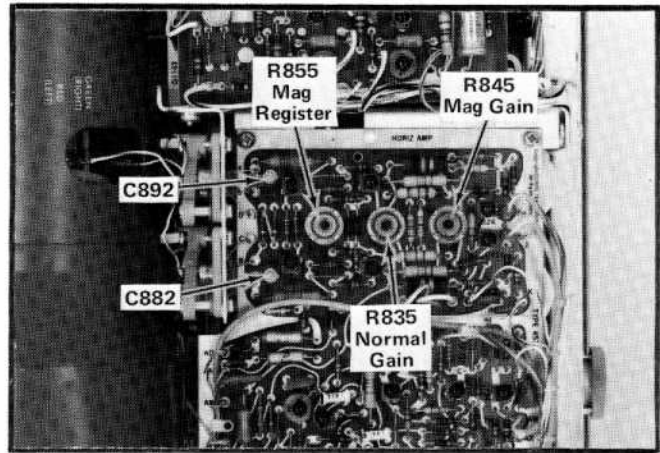


Fig. 5-14. Location of Horizontal Amplifier adjustments (B Sweep board).

c. CHECK—CRT display for one marker each division between the first and ninth graticule lines.

d. ADJUST—Mag Gain adjustment R845 (see Fig. 5-14) for one marker each division. The second and tenth markers must coincide exactly with their respective graticule lines (reposition the display slightly with the horizontal FINE control if necessary).

e. INTERACTION—Check steps 24, 27, and 28.

24. Adjust Magnifier Register

a. Set the time-mark generator for five-millisecond markers.

b. Position the middle marker (three markers on total magnified sweep) to the center vertical line.

c. Set the MAG switch to OFF.

d. CHECK—Middle marker should remain within 0.2 division of the center vertical line.

e. ADJUST—Mag Register adjustment R855 (see Fig. 5-14) to position the middle marker to the center vertical line.

f. Set the MAG switch to X10.

g. Repeat parts b through e until no shift occurs when the MAG switch is set to OFF.

25. Adjust B Sweep Calibration

a. Change the following control settings:

A LEVEL	Stable A display
DELAY-TIME	0.20
MULTIPLIER	
A TIME/DIV	2 ms
B TIME/DIV	1 ms
B SWEEP MODE	TRIGGERABLE AFTER DELAY TIME
HORIZ DISPLAY	B (DELAYED SWEEP)
MAG	OFF

b. Set the time-mark generator for one-millisecond markers.

c. Set the B LEVEL control for a stable display.

d. CHECK—CRT display for one marker each division between the first and ninth graticule lines.

e. ADJUST—B Sweep Cal adjustment R741 (see Fig. 5-13) for one marker each division.

26. Adjust A and B One-Microsecond Timing

a. Change the following control settings:

A and B TIME/DIV	1 μ s
HORIZ DISPLAY	A

b. Set the time-mark generator for one-microsecond markers.

c. Set the A LEVEL control for a stable display.

d. CHECK—CRT display for one marker each division between the first and ninth graticule lines.

e. ADJUST—C530A (behind swing-out side panel; see Fig. 5-15) for one marker each division (use low-capacitance screwdriver).

f. Set the HORIZ DISPLAY switch to B (DELAYED SWEEP).

g. Set the B LEVEL control for a stable display.

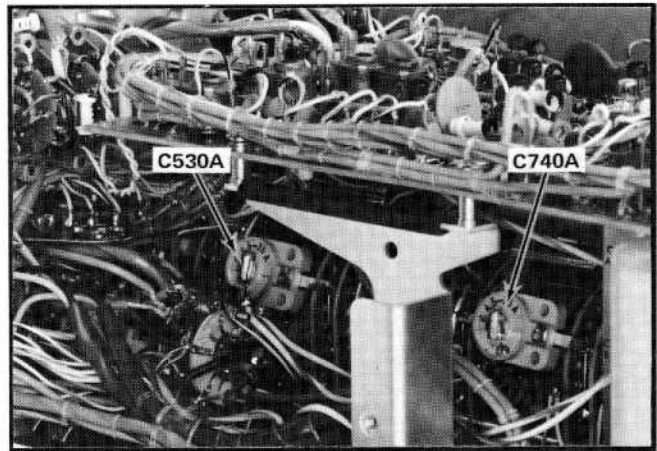


Fig. 5-15. Location of one-microsecond timing adjustments (behind swing-out side panel).

h. CHECK—CRT display for one marker each division between the first and ninth division graticule lines.

i. ADJUST—C740A (see Fig. 5-15) for one marker each division (use low-capacitance screwdriver).

27. Adjust High-Speed Linearity

a. Change the following control settings:

CH 1 VOLTS/DIV	.1
A and B TIME/DIV	.1 μ s
HORIZ DISPLAY	A

b. Set the time-mark generator for 10-nanosecond markers.

c. Position the display horizontally so the sweep starts at the left edge of the graticule.

d. Set the MAG switch to X10.

e. Set the A LEVEL and HF STAB controls for a stable display.

f. CHECK—CRT display for optimum linearity over the center eight divisions of the graticule.

g. ADJUST—C882 and C892 (see Fig. 5-14) for optimum linearity over the center eight divisions of the graticule (attempt to keep C882 and C892 nearly equal in capacitance, by adjusting each capacitor about the

same amount). Use low-capacitance screwdriver for this adjustment.

h. Disconnect all test equipment.

28. Adjust X Gain

a. Change the following control settings:

CH 1 and 2 VOLTS/DIV	20 mV
MODE	CH 2
INT TRIG	CH 1 OR X-Y
B COUPLING	DC
HORIZ DISPLAY	X-Y
MAG	OFF

b. Connect the standard amplitude calibrator to the CH 1 OR X connector with the 42-inch BNC cable.

c. Set the standard amplitude calibrator for a 0.1-volt square-wave output.

d. Increase the INTENSITY control setting until the display is visible (two dots about five divisions apart).

e. Move the display to the center of the graticule with the Channel 1 POSITION control.

f. CHECK—CRT display for five divisions horizontal deflection.

g. ADJUST—Ext Horiz Gain adjustment R645 (see Fig. 5-13) for five divisions horizontal deflection.

This completes the Calibration Procedure for the 453A. Disconnect all test equipment and secure the swing-out side panel. Replace the top and bottom cover.

SECTION 6

RACKMOUNTING

Change information, if any, affecting this section will be found at the rear of this manual.

Introduction

The Tektronix R453A Oscilloscope is designed to mount in a standard 19-inch rack. When mounted in accordance with the following mounting procedure, the instrument will meet all electrical and environmental characteristics given in Section 1.

Instrument Dimensions

A dimensional drawing showing the major dimensions of the R453A is shown in Fig. 6-11.

Rack Dimensions

Height. At least seven inches of vertical space is required to mount this instrument in a rack.

Width. Minimum width of the opening between the left and right front rails of the rack must be 17 5/8 inches. This allows room on each side of the instrument for the slide-out tracks to operate freely, permitting the instrument to move smoothly in and out of the rack.

Depth. Total depth necessary to mount the R453A in a cabinet rack is 18 inches. This allows room for air circulation, power cord connections and the necessary mounting hardware.

Slide-Out Tracks

The slide-out tracks provided with the R453A permit it to be extended out of the rack for maintenance or calibration without removing the instrument from the rack. In the fully extended position, the R453A can be tilted up so the bottom of the instrument can be reached for maintenance or calibration. To operate the R453A in the extended position, be sure the power cord and any interconnecting cables are long enough for this purpose.

The slide-out tracks consist of two assemblies—one for the left side of the instrument and one for the right side. Fig. 6-1 shows the complete slide-out track assemblies. The stationary section of each assembly attaches to the front and rear rails of the rack, and the chassis section is attached to the instrument. The intermediate section slides between

the stationary and chassis sections and allows the R453A to be extended out of the rack. When the instrument is shipped, the stationary and intermediate sections of the tracks are packaged as matched sets and should not be separated. To identify the left or right assembly, note the position of the automatic latch (see Fig. 6-1). When mounted in the rack, the automatic latch should be at the top of both assemblies. The chassis sections are installed on the instrument at the factory.

The hardware needed to mount the slide-out tracks is shown in Fig. 6-2. Since the hardware supplied is intended to make the tracks compatible with a variety of cabinet racks and installation methods, not all of it will be needed for this installation. Use only the hardware that is required for the mounting method used.

Mounting Procedure

The following mounting procedure uses the rear support kit (see Figs. 6-3 and 6-4) to meet the environmental characteristics of the instrument (shock and vibration). Two alternative mounting methods are described at the end of this procedure. However, when mounted according to these alternative methods, the instrument may not meet the given environmental characteristics for shock and vibration.

The mounting flanges of the stationary sections may be mounted in front of or behind the front rails of the rack, depending on the type of rack. If the front rails of the rack are tapped for 10-32 screws, the mounting flanges are placed in front of the rails. If the front rails of the rack are not tapped for 10-32 screws, the mounting flanges are placed behind the front rail and a bar nut is used. Fig. 6-5 shows these methods of mounting the stationary sections.

The rear of the stationary sections must be firmly supported to provide a shock-mounted installation. This rear support must be located 17.471 inches, ± 0.031 inch, from the outside surface of the front rail when the mounting flange is mounted outside of the rail, or 17.531 inches, ± 0.031 inch, from the rear surface of the front rail when the mounting flange is mounted behind the front rail. If the cabinet rack does not have a strong supporting member located the correct distance from the front rail, an additional support must be added. The instrument will not meet the environmental specifications unless firmly supported at

Rackmounting—453A/R453A

this point. Fig. 6-4 illustrates a typical rear installation using the rear support kit and gives the necessary dimensions.

Use the following procedure to install the R453A in a rack:

1. Select the proper front-rail mounting holes for the stationary section using the measurements shown in Fig. 6-5.

2a. If the mounting flanges of the stationary sections are to be mounted in front of the front rails (rails tapped for 10-32 screws), mount each stationary section as shown in Fig. 6-4A.

2b. If the mounting flanges of the stationary sections are to be mounted behind the front rails (rails not tapped for 10-32 screws), mount each stationary section as shown in Fig. 6-4B.

3. Attach an angle bracket to both rear rails of the rack through the spacer block, stationary section and into the rear rail of the rack. Note that the holes in the spacer block are not centered. Be sure to mount the block with the narrow edge toward the front of the rack; otherwise, the instrument may not slide all the way into the rack. Do not tighten the mounting screws. Fig. 6-6 shows the parts in the rear support kit and the order in which they are assembled.

4. Assemble the support pin to the angle bracket in the order shown in Fig. 6-6. Leave the spacer (washer) off, but install the neoprene washer.

5. Install a support block on each side of the instrument as shown in Fig. 6-7.

6. Refer to Fig. 6-8 to insert the instrument in the rack. Do not connect the power cord or install the securing screws until all adjustments have been made.

7. With the instruments pushed all the way into the rack, adjust the angle brackets so the neoprene washers on the support pins are seated firmly against the rear of the instrument and the support pins are correctly positioned in the support block on the rear of the instrument. Tighten all screws.

8. Pull the instrument partially out of the rack.

9. Remove the neoprene washers from the support pins and place the spacers on the pins. Replace the neoprene washers.

10. Position the instrument so the pivot screws (widest part of the instrument) are approximately even with the front rails.

11. Adjust the alignment of the stationary sections according to the procedure outlined in Fig. 6-9. (If the rear alignment is changed, recheck the rear support pins for correct alignment.)

12. After the tracks operate smoothly, connect the power cord to the power source.

13. Push the instrument all the way into the rack and secure it to the rack with the securing screws and washers as shown in Fig. 6-8.

NOTE

The securing screws are an important part of the shock-mounted installation. If the front rails are not tapped for the 10-32 securing screws, other means must be provided for securing the instrument to the rack.

Alternative Rear Mounting Methods

CAUTION

Although the following methods provide satisfactory mounting under normal conditions, they do not provide solid support at the rear of the instrument. If the instrument is subjected to severe shock or vibration when mounted using the following methods, it may be damaged.

An alternative method of supporting the rear of the instrument is shown in Fig. 6-10. The rear support brackets supplied with the instrument allow it to be mounted in a rack which has a spacing between the front and rear rails of 11 to 24 inches. Fig. 6-10A illustrates the mounting method if the rear rails are tapped for 10-32 screws, and Fig. 6-10B illustrates the mounting method if the rear rails are not tapped for 10-32 screws. The rear support kit is not used for this installation.

If the rack does not have a rear rail, or if the distance between the front and rear rails is too large, the instrument may be mounted without the use of the slide-out tracks.

Fasten the instrument to the front rails of the rack with the securing screws and washers. This mounting method should be used only if the instrument will not be subjected to shock or vibration and if it is installed in a stationary location.

Removing or Installing the Instrument

After initial installation and adjustment of the slide-out tracks, the R453A can be removed or installed by following

the instructions given in Fig. 6-8. No further adjustments are required under normal conditions.

Slide-Out Track Lubrication

The slide-out tracks normally require no lubrication. The special finish on the sliding surfaces provides permanent lubrication. However, if the tracks do not slide smoothly even after proper adjustment, a thin coating of paraffin rubbed onto the sliding surfaces may improve operation.

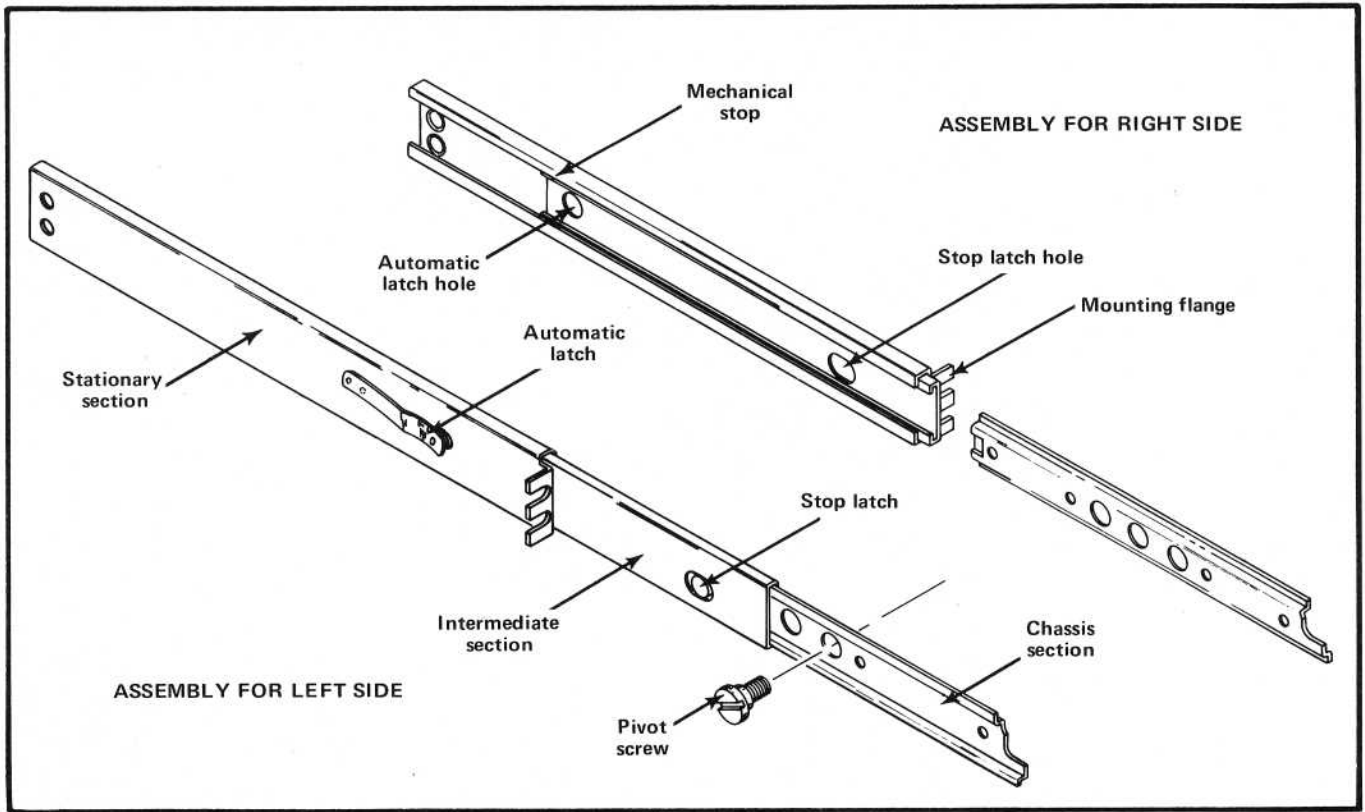


Fig. 6-1. Slide-out track assemblies.

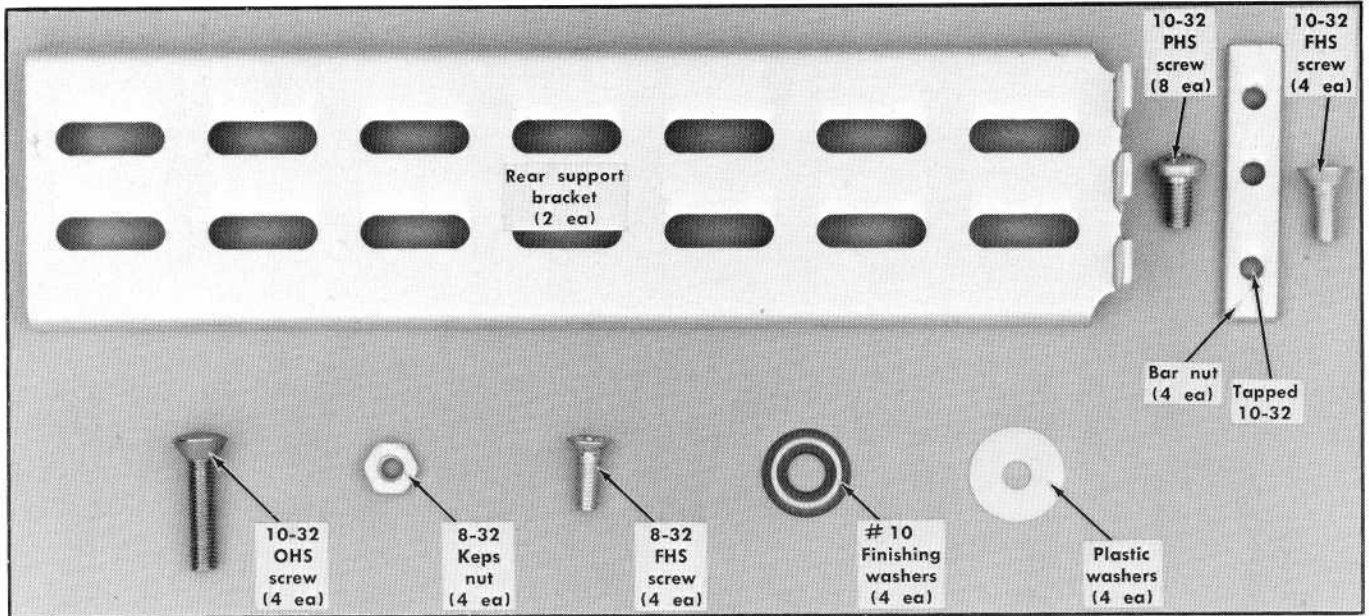


Fig. 6-2. Hardware needed to mount the instrument in the cabinet rack.

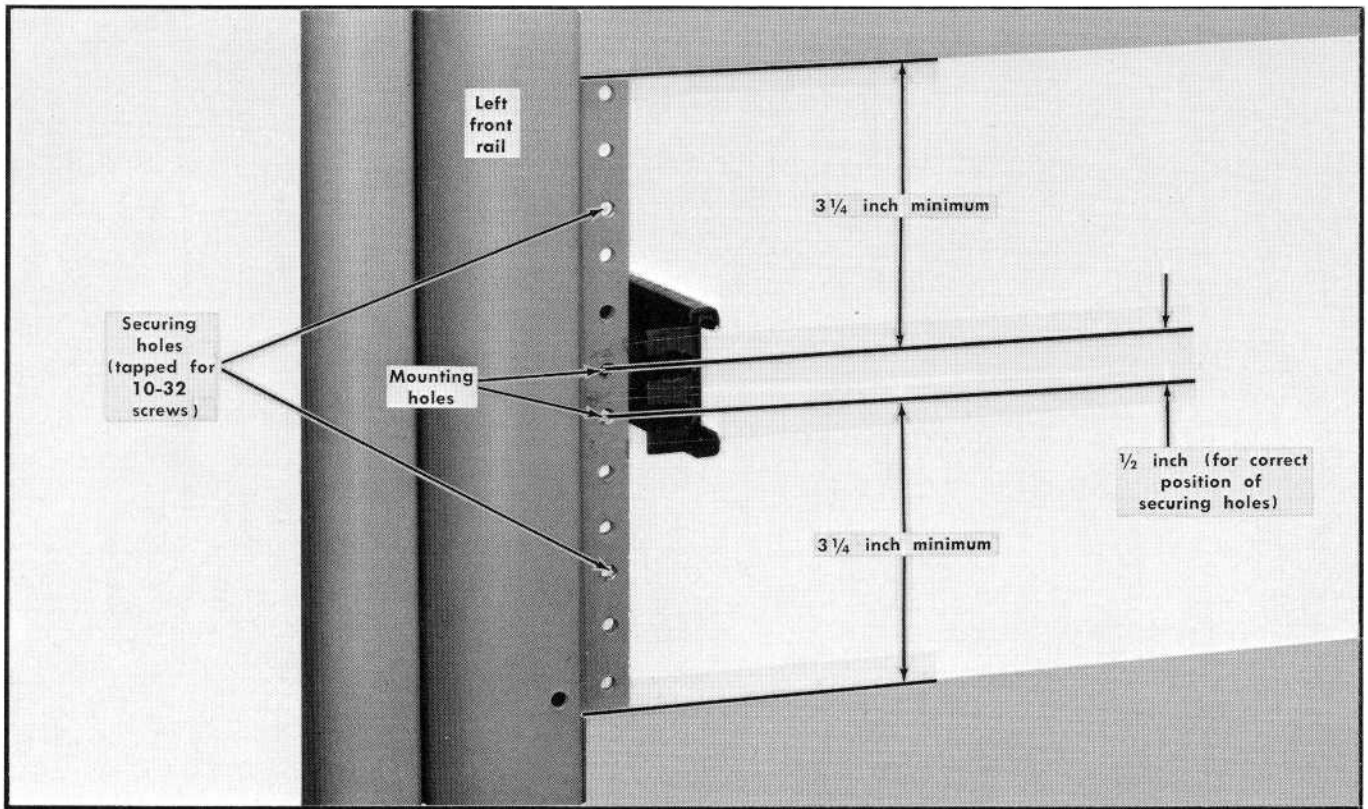


Fig. 6-3. Locating the mounting holes for the left stationary section. Same dimensions apply to right stationary section.

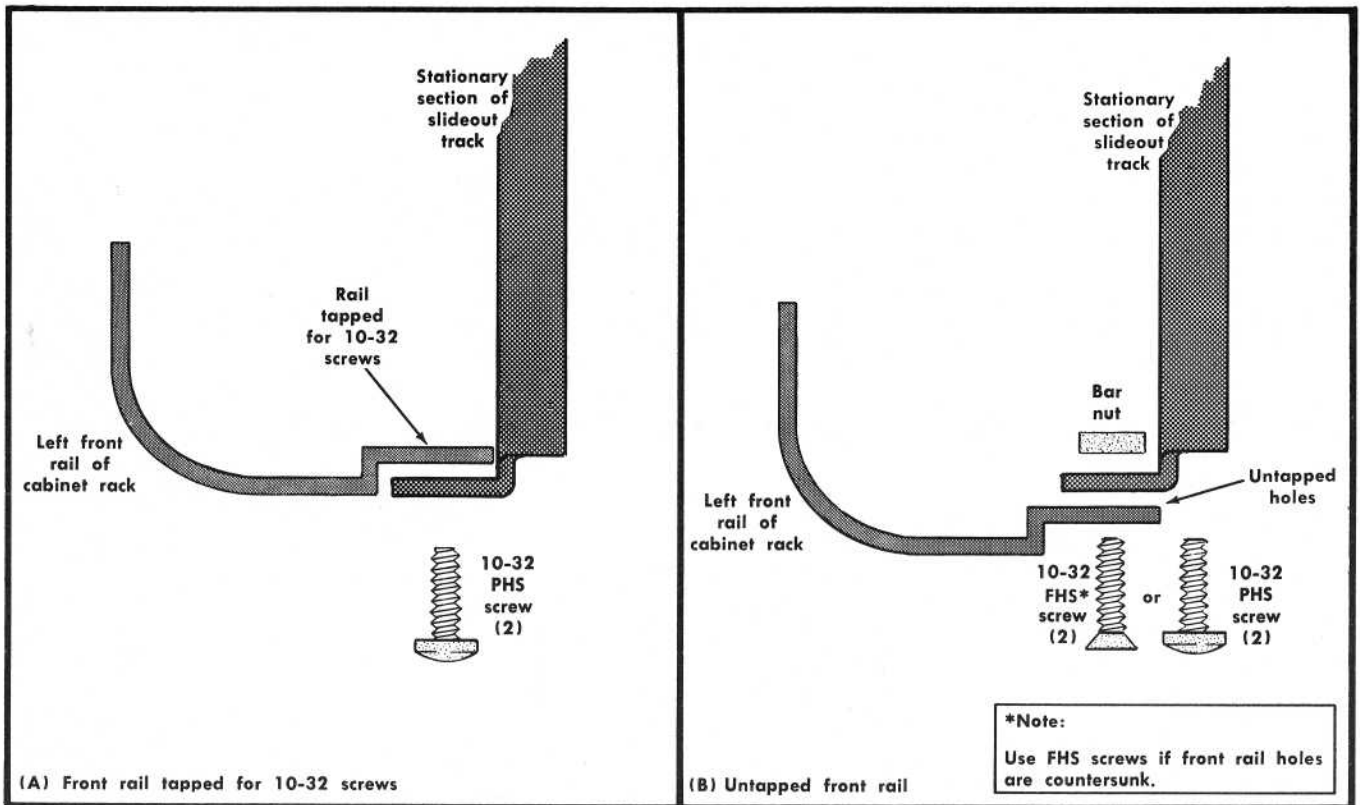


Fig. 6-4. Methods of mounting the stationary section to the front rails.

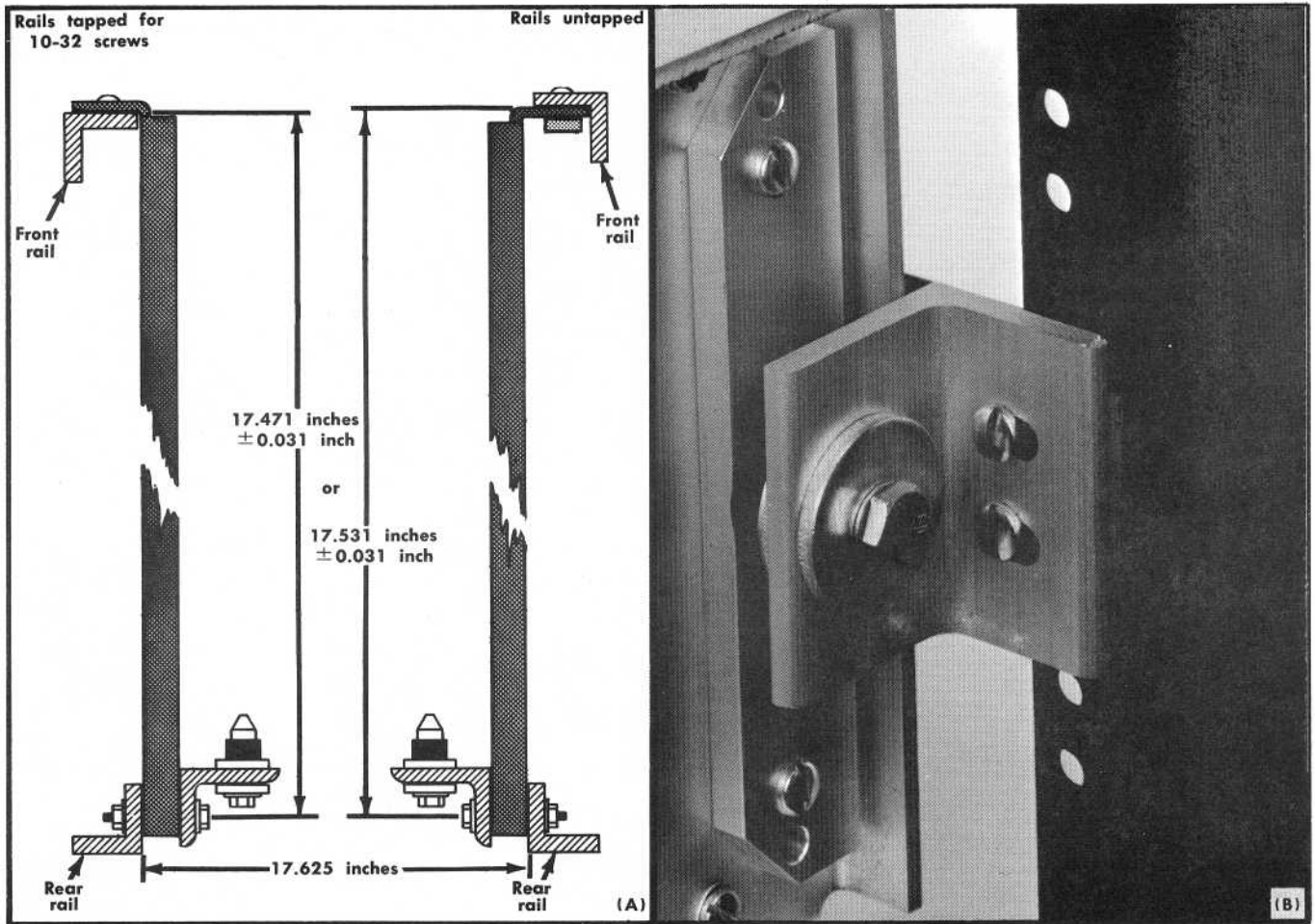


Fig. 6-5. Supporting the rear of the stationary sections: (A) Dimensions necessary; (B) Completed installation.

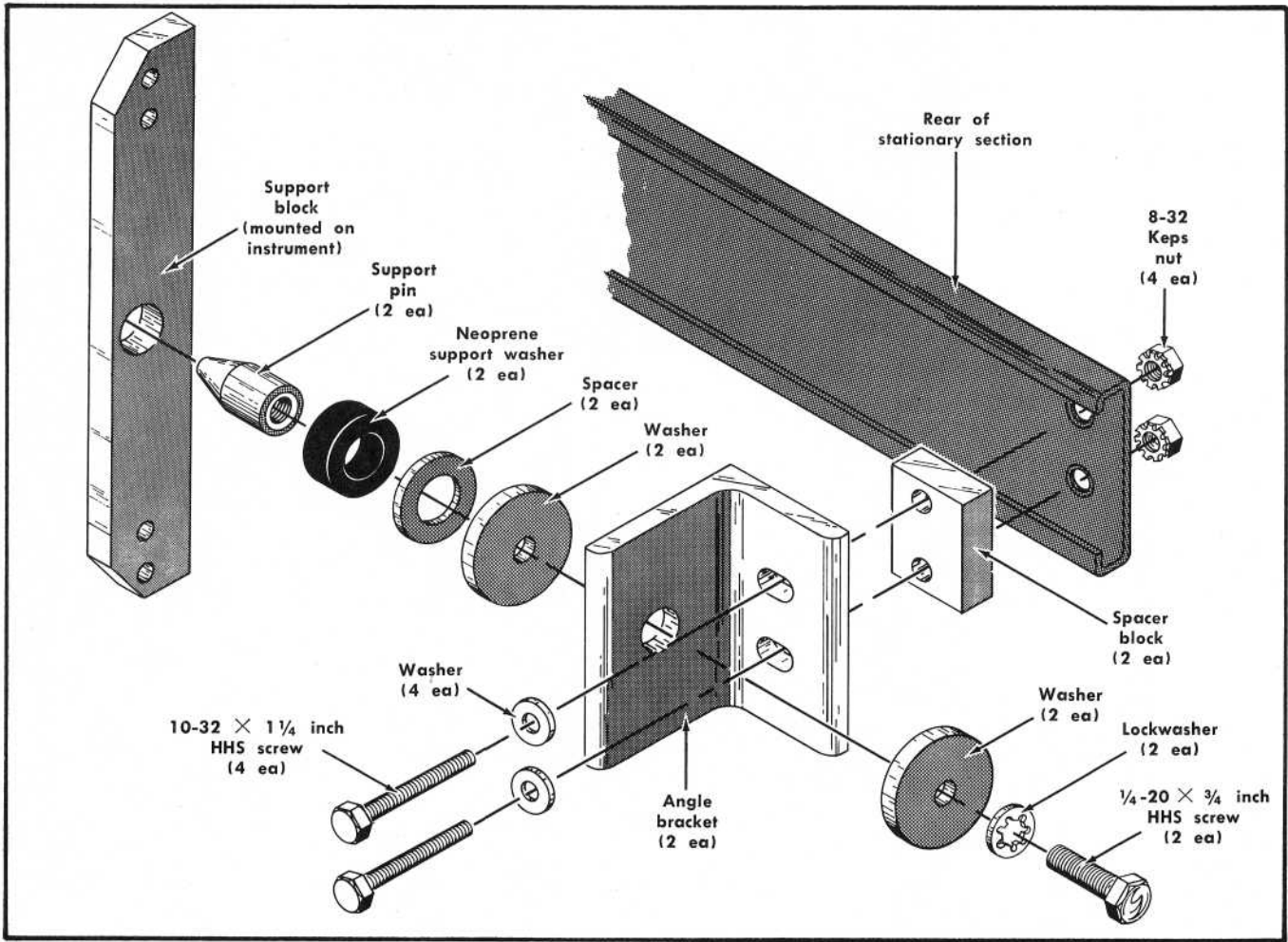


Fig. 6-6. Rear Support kit.

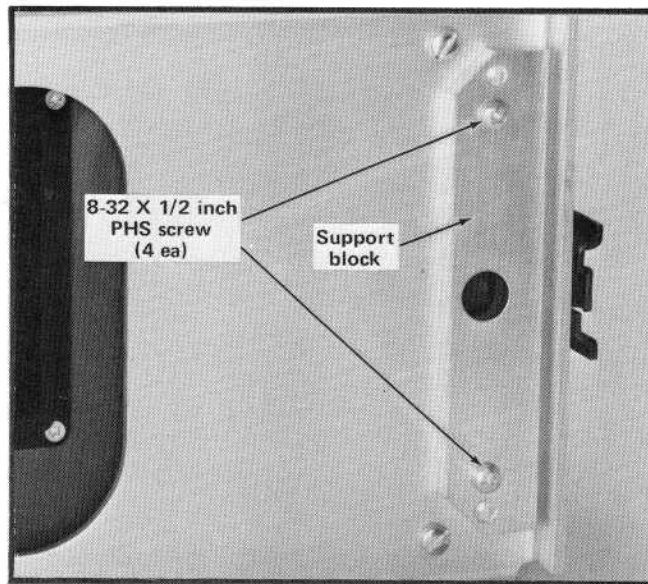


Fig. 6-7. Installing the support block on the instrument.

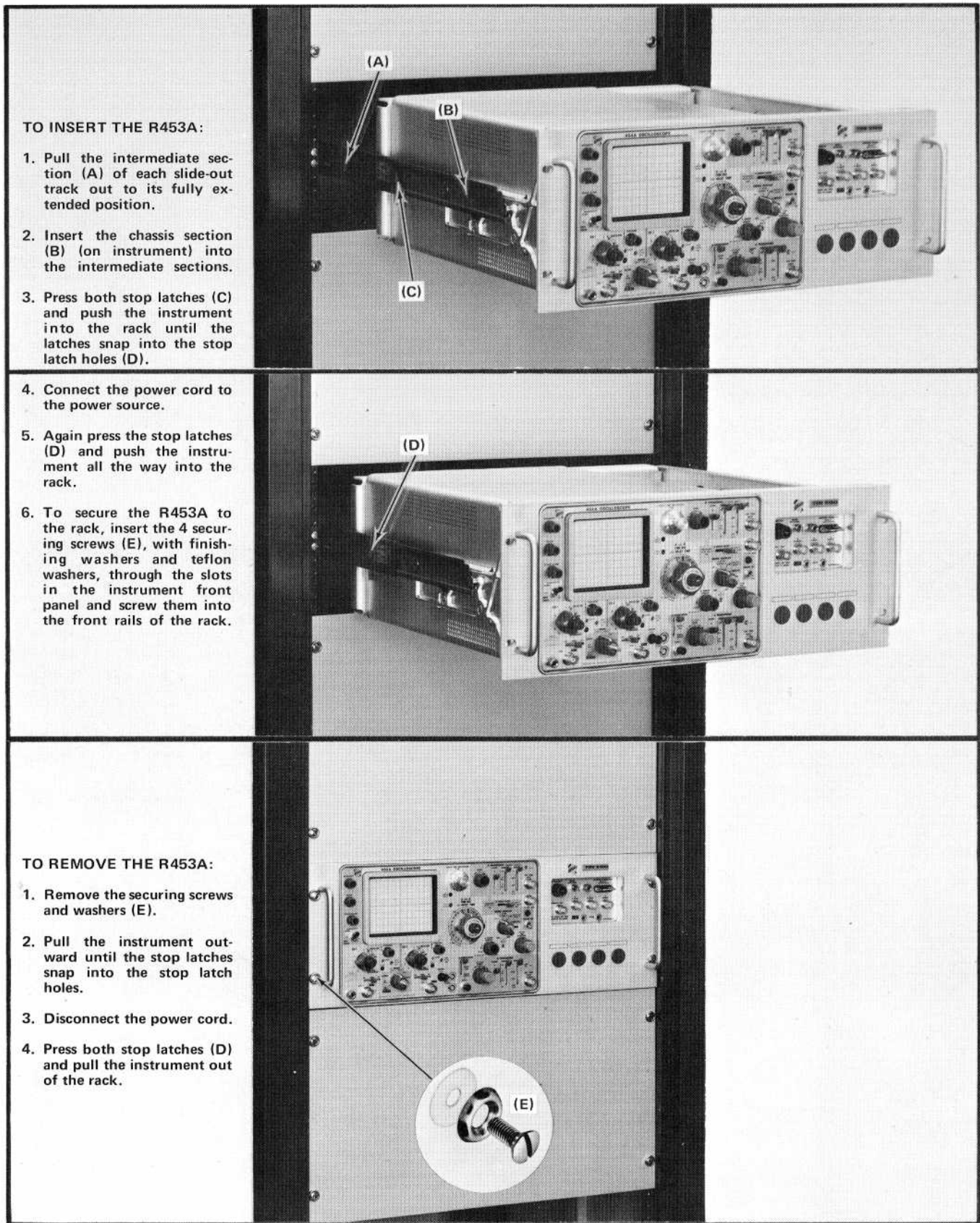


Fig. 6-8. Procedure for inserting or removing the instrument after the slide-out tracks have been installed.

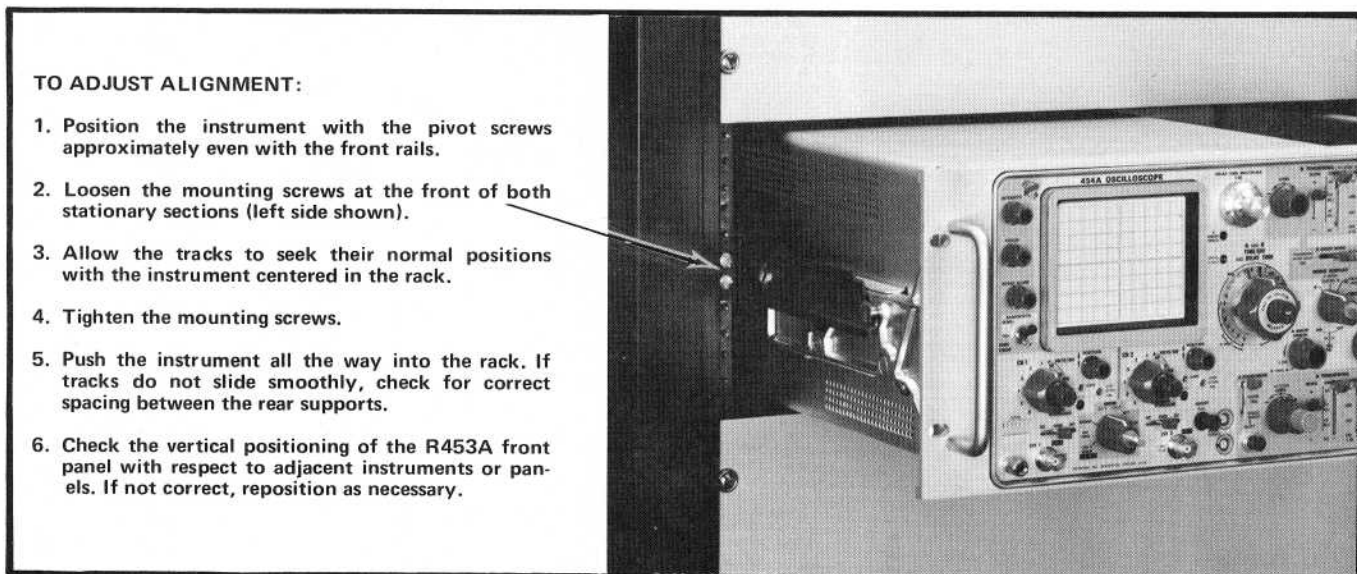


Fig. 6-9. Alignment adjustments for correct operation.

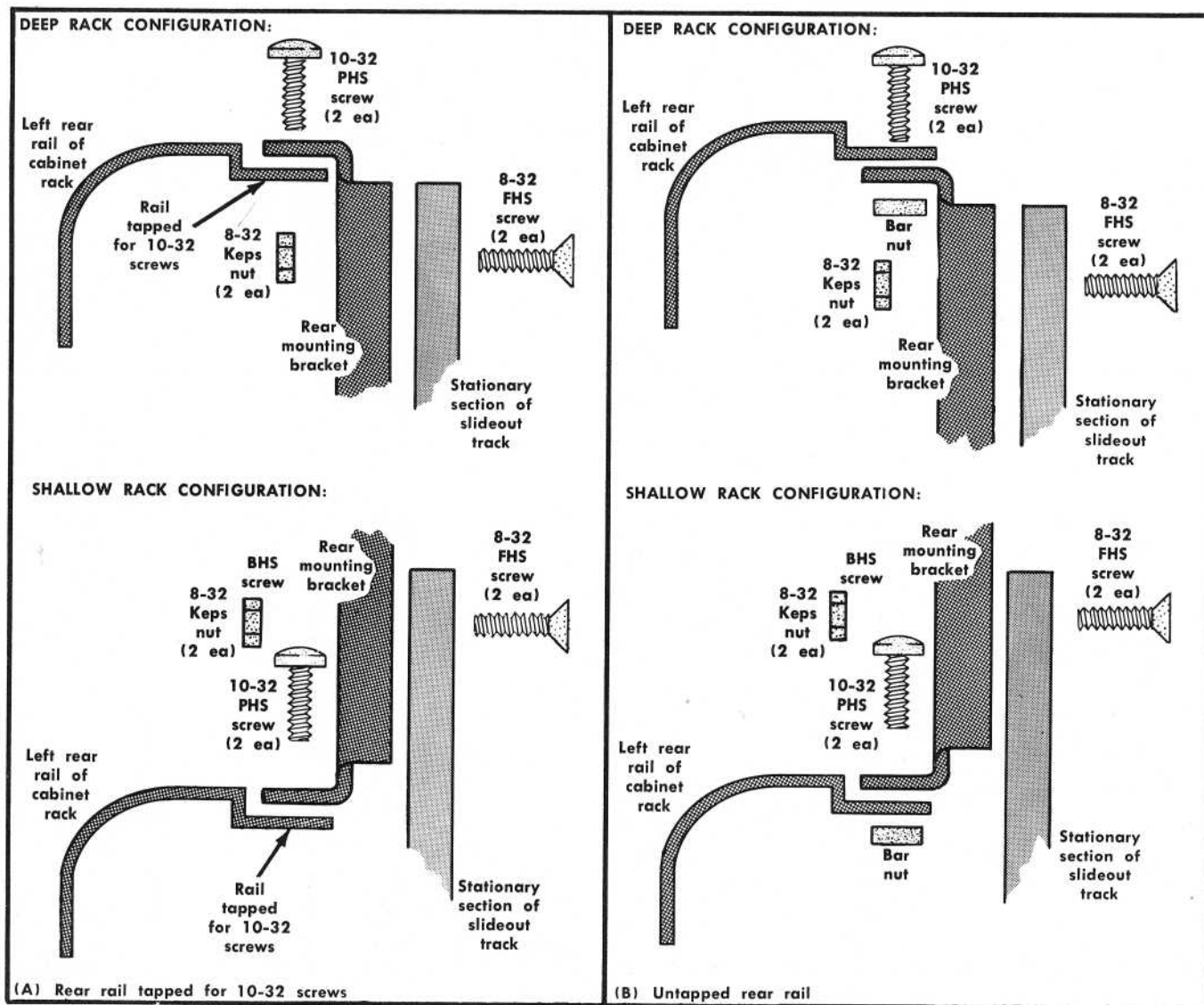
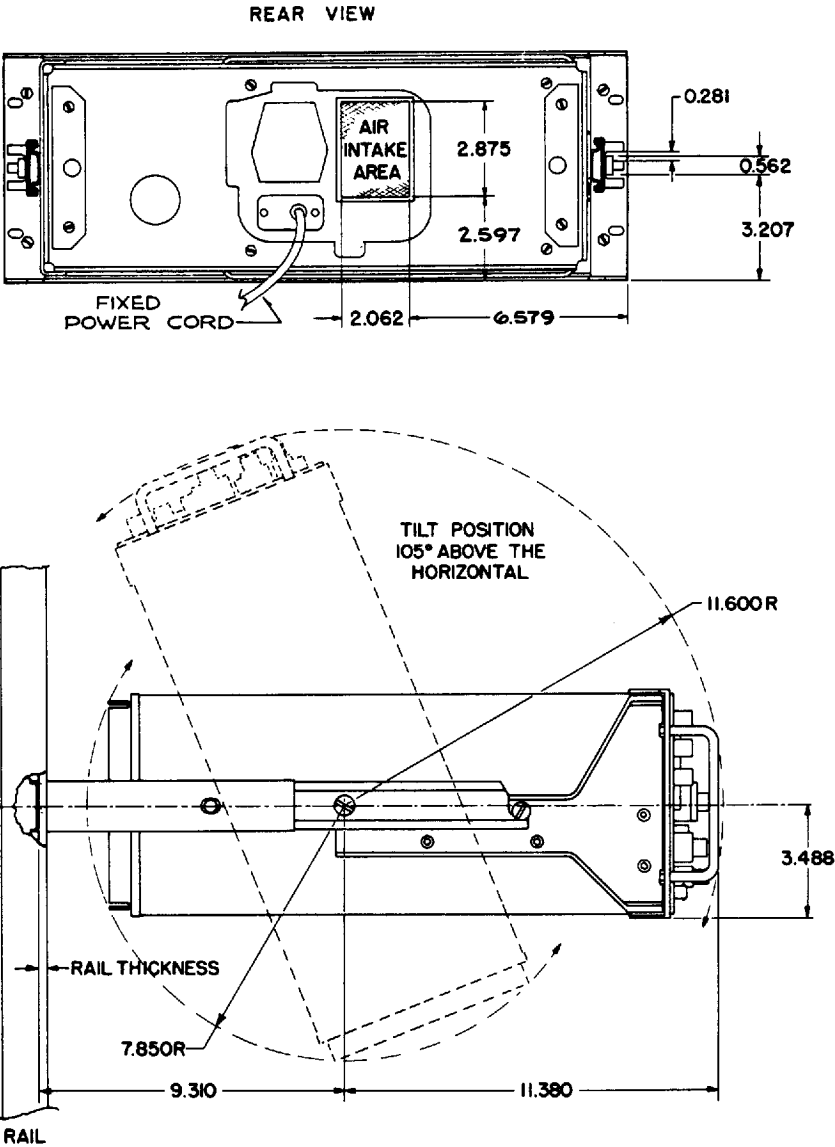


Fig. 6-10. Alternative method of installing the instrument using rear support brackets.



NOTES:
 1. ALL DIMENSIONS ARE REFERENCE DIMENSIONS EXCEPT AS NOTED

RACK RAIL TYPES

ALTERNATE TYPE DRILLING 0.187 THICK MOUNTING RAIL	19.125 ±0.062 CABINET OPENING FOR 19" PANEL	UNIVERSAL TYPE DRILLING 0.125-0.187 THICK MOUNTING RAIL
	18.312	
	17.875 CLEAR OPENING	
1.250	0.625	CABINET PANEL MOUNTING SPACE 1.750 MULTIPLES
0.500	0.500	
1.250	0.625	
0.500	0.500	
0.500	0.500	
1.250	0.625	
0.500	0.500	
1.250	0.625	
0.500	0.500	
1.250	0.625	
0.250 -0.000 TOP & BOTTOM	0.250 -0.000 TOP & BOTTOM	
TAP # 10-32 NF-2	TAP # 10-32 NF-2	

Fig. 6-11. Dimensional Drawing.

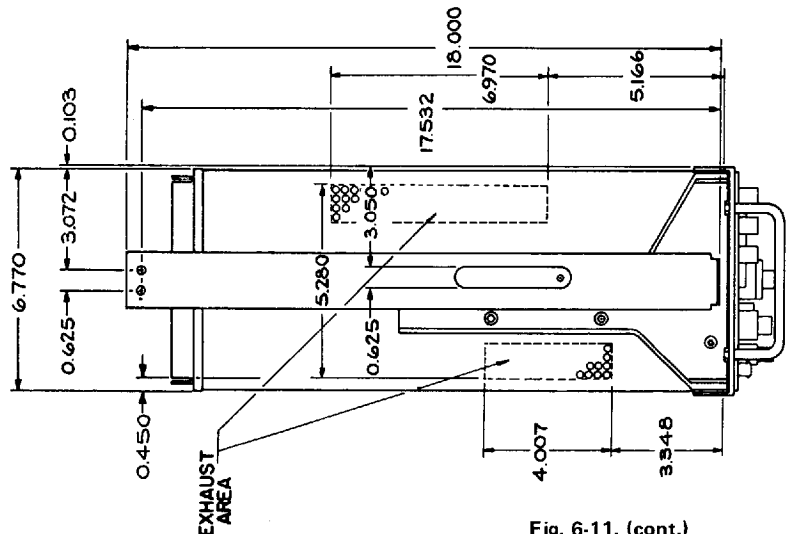
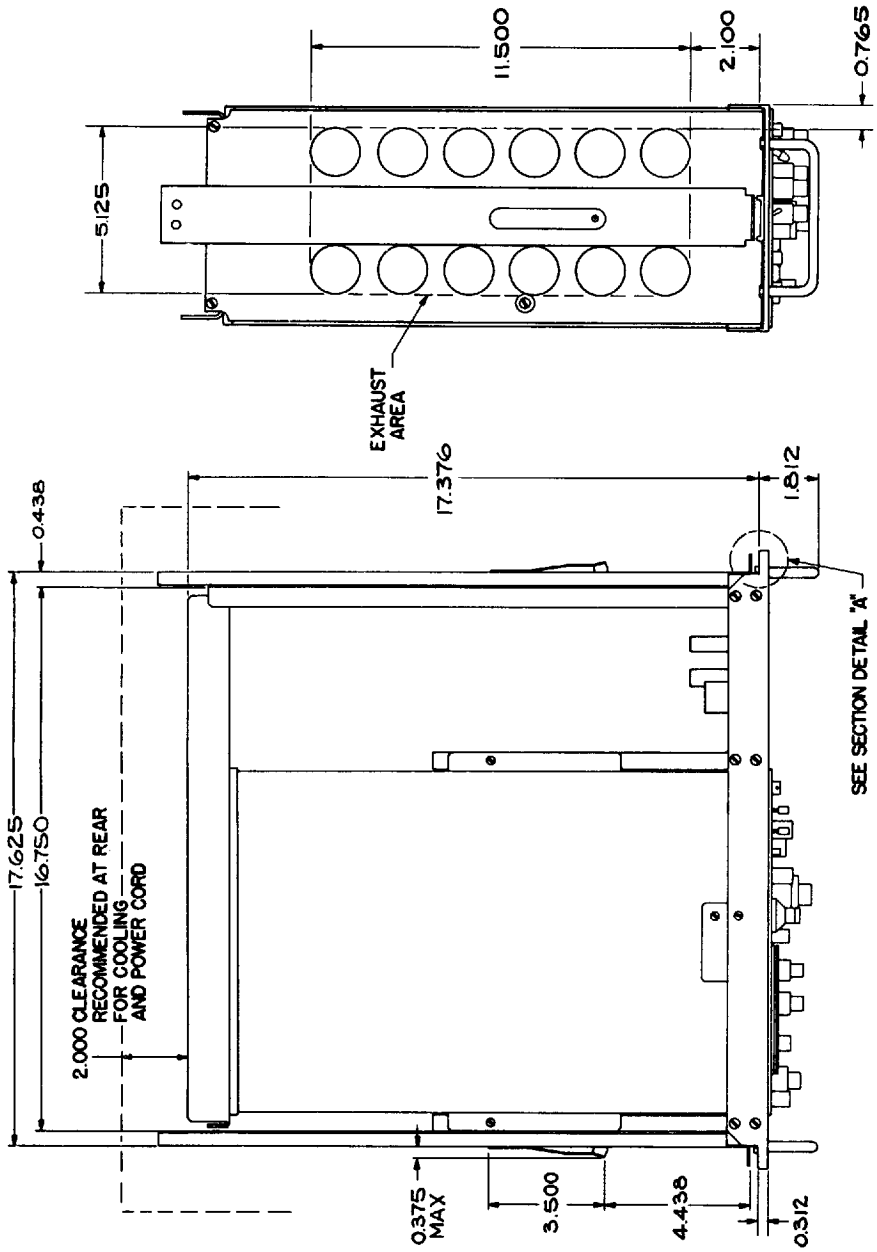
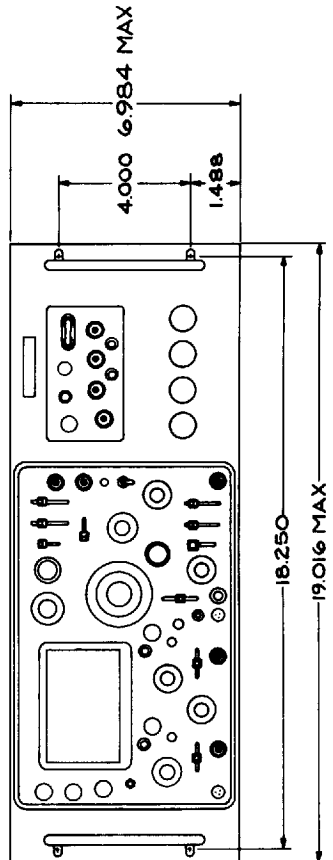


Fig. 6-11. (cont.)





PARTS LIST ABBREVIATIONS

BHB	binding head brass	int	internal
BHS	binding head steel	lg	length or long
cap.	capacitor	met.	metal
cer	ceramic	mtg hdw	mounting hardware
comp	composition	OD	outside diameter
conn	connector	OHB	oval head brass
CRT	cathode-ray tube	OHS	oval head steel
csk	countersunk	P/O	part of
DE	double end	PHB	pan head brass
dia	diameter	PHS	pan head steel
div	division	plstc	plastic
elect.	electrolytic	PMC	paper, metal cased
EMC	electrolytic, metal cased	poly	polystyrene
EMT	electrolytic, metal tubular	prec	precision
ext	external	PT	paper, tubular
F & I	focus and intensity	PTM	paper or plastic, tubular, molded
FHB	flat head brass	RHB	round head brass
FHS	flat head steel	RHS	round head steel
Fil HB	fillister head brass	SE	single end
Fil HS	fillister head steel	SN or S/N	serial number
h	height or high	S or SW	switch
hex.	hexagonal	TC	temperature compensated
HHB	hex head brass	THB	truss head brass
HHS	hex head steel	thk	thick
HSB	hex socket brass	THS	truss head steel
HSS	hex socket steel	tub.	tubular
ID	inside diameter	var	variable
inc	incandescent	w	wide or width
		WW	wire-wound

PARTS ORDERING INFORMATION

Replacement parts are available from or through your local Tektronix, Inc. Field Office or representative.

Changes to Tektronix instruments are sometimes made to accommodate improved components as they become available, and to give you the benefit of the latest circuit improvements developed in our engineering department. It is therefore important, when ordering parts, to include the following information in your order: Part number, instrument type or number, serial or model number, and modification number if applicable.

If a part you have ordered has been replaced with a new or improved part, your local Tektronix, Inc. Field Office or representative will contact you concerning any change in part number.

SPECIAL NOTES AND SYMBOLS

- | | |
|-----------------|---|
| ×000 | Part first added at this serial number |
| 00× | Part removed after this serial number |
| *000-0000-00 | Asterisk preceding Tektronix Part Number indicates manufactured by or for Tektronix, Inc., or reworked or checked components. |
| Use 000-0000-00 | Part number indicated is direct replacement. |

INDEX OF ELECTRICAL PARTS LIST

Title	Page No.
CHASSIS	7-1
A1 VERTICAL PREAMP Circuit Board Assembly	7-12
A2 VERTICAL OUTPUT Circuit Board Assembly	7-19
A3 A SWEEP Circuit Board Assembly	7-21
A4 B SWEEP Circuit Board Assembly	7-27
A5 Z AXIS Circuit Board Assembly	7-34
A6 LOW VOLTAGE REGULATOR Circuit Board Assembly	7-36

SECTION 7

ELECTRICAL PARTS LIST

Values are fixed unless marked Variable.

Ckt. No.	Tektronix Part No.	Serial/Model No. Eff	Disc	Description		
CHASSIS						
Motor						
B1200	147-0027-00	B010100	B089999	48 - 40 Hz		
B1200	147-0033-01	B090000		48 - 62 Hz		
Capacitors						
Tolerance $\pm 20\%$ unless otherwise indicated.						
C1	*285-0697-04			0.1 μ F	MT	600 V
C3	281-0617-00			15 pF	Cer	200 V
C6B	281-0064-00			0.25-1.5 pF, Var	Tub.	
C6C	281-0102-00			1.7-11 pF, Var	Air	
C7B	281-0064-00			0.25-1.5 pF, Var	Tub.	
C7C	281-0100-00			1.4-7.3 pF, Var	Air	
C7E	281-0505-00			12 pF	Cer	500 V
C8B	281-0099-00			1.3-5.4 pF, Var	Air	10%
C8C } C8E }	281-0083-00			0.25-1.5 pF, Var	Tub.	
				50 pF	Mica	10%
C8D	281-0544-00			5.6 pF (nominal value)	Selected	
C9B	281-0100-00			1.4-7.3 pF, Var	Air	
C9C } C9E }	281-0086-00			0.25-1.5 pF, Var	Tub.	
C9D	281-0593-00			500 pF	Mica	10%
				3.9 pF (nominal value)	Selected	
C9F	281-0547-00			2.7 pF	Cer	500 V
C10	281-0529-00			1.5 pF	Cer	500 V
C11	281-0099-00			1.3-5.4 pF, Var	Air	± 0.25 pF
C13	281-0617-00			15 pF	Cer	200 V
C43E	281-0578-00			18 pF	Cer	500 V
						5%
C44B	281-0592-00			4.7 pF	Cer	500 V
C73	281-0534-00			3.3 pF	Cer	± 0.5 pF
C100	283-0092-00			0.03 μ F	Cer	200 V
C101	*285-0697-04			0.1 μ F	MT	600 V
C103	281-0617-00			15 pF	Cer	200 V
						± 0.25 pF
						+80% -20%
C106B	281-0064-00			0.25-1.5 pF, Var	Tub.	
C106C	281-0102-00			1.7-11 pF, Var	Air	
C107B	281-0064-00			0.25-1.5 pF, Var	Tub.	
C107C	281-0100-00			1.4-7.3 pF, Var	Air	
C107E	281-0505-00			12 pF	Cer	500 V
						10%
C108B	281-0099-00			1.3-5.4 pF, Var	Air	
C108C } C108E }	281-0083-00			0.25-1.5 pF, Var	Tub.	
				50 pF	Mica	10%

CHASSIS (cont)

Ckt. No.	Tektronix Part No.	Serial/Model No. Eff	No. Disc	Description
Capacitors (cont)				
C108D	281-0544-00			5.6 pF (nominal value) Selected
C109B	281-0100-00			1.4-7.3 pF, Var Air
C109C } C109E } C109D }	281-0086-00			0.25-1.5 pF, Var Tub., Mica
	281-0593-00			500 pF Mica 10%
				3.9 pF (nominal value) Selected
C109F	281-0547-00			2.7 pF Cer 500 V 10%
C110	281-0529-00			1.5 pF Cer 500 V ±0.25 pF
C111	281-0099-00			1.3-5.4 pF, Var Air
C113	281-0617-00			15 pF Cer 200 V
C143E	281-0578-00			18 pF Cer 500 V 5%
C144B	281-0592-00			4.7 pF Cer 500 V ±5 pF
C173	281-0534-00			3.3 pF Cer ±0.25 pF
C295	283-0080-00			0.022 μF Cer 25 V +80%—20%
C296	283-0080-00			0.022 μF Cer 25 V +80%—20%
C365	283-0092-00			0.03 μF Cer 200 V +80%—20%
C432	281-0510-00			22 pF Cer 500 V
C433A	281-0505-00			12 pF Cer 500 V 10%
C433B	281-0557-00			1.8 pF Cer 500 V
C435	283-0013-00			0.01 μF Cer 1000 V
C436	281-0523-00			100 pF Cer 350 V
C530A	281-0010-00			4.5-25 pF, Var Cer
C530B	283-0097-00			84 pF Cer 1000 V 2%
C530C } C530D } C530E } C530F } C530G }	*295-0089-00			0.001 μF 0.01 μF 0.1 μF 1 μF 10 μF Timing capacitor assembly
C530H	281-0523-00			100 pF Cer 350 V
C530J	281-0523-00			100 pF Cer 350 V
C530K	283-0032-00			470 pF Cer 500 V 5%
C550C	281-0551-00			390 pF Cer 500 V 10%
C550D	285-0699-00			0.0047 μF PTM 100 V 10%
C550E	290-0282-00			0.047 μF Elect. 35 V 10%
C550F	290-0283-00			0.47 μF Elect. 35 V 10%
C550G	290-0284-00			4.7 μF Elect. 35 V 10%
C559	283-0081-00			0.1 μF Cer 25 V +80%—20%
C569	283-0092-00			0.03 μF Cer 200 V +80%—20%
C602	281-0510-00			22 pF Cer 500 V
C613A	281-0505-00			12 pF Cer 500 V 10%
C613B	281-0557-00			1.8 pF Cer 500 V
C615	283-0013-00			0.01 μF Cer 1000 V
C616	281-0523-00			100 pF Cer 350 V

¹Individual timing capacitors in this assembly must be ordered by the 9 digit part number, letter suffix and tolerance printed on the timing capacitor to be replaced.

Example:

F—

285-XXXX-XX

The letter suffix and the tolerance should be the same for all of the timing capacitors in the assembly.

CHASSIS (cont)

Ckt. No.	Tektronix Part No.	Serial/Model No. Eff	Disc	Description			
Capacitors (cont)							
C740A	281-0010-00			4.5-25 pF, Var			
C740B	283-0097-00			84 pF,	Cer	1000 V	2%
C740C	*295-0079-00			0.001 μ F			
C740D				0.01 μ F			
C740E				0.1 μ F			
C740F				1 μ F			
						Timing capacitor assembly	
C740H	281-0523-00			100 pF	Cer	350 V	
C808	290-0267-00			1 μ F	Elect.	35 V	
C886	285-0572-00			0.1 μ F	PTM	200 V	
C906	283-0044-00			0.001 μ F	Cer	3000 V	
C911	290-0159-00			2 μ F	Elect.	150 V	
C937	290-0312-00	B010100	B099999	47 μ F	Elect.	35 V	10%
C937	290-0287-00	B100000		47 μ F	Elect.	25 V	
C940	283-0120-00			0.015 μ F	Cer	2500 V	+80%—20%
C945	283-0120-00			0.015 μ F	Cer	2500 V	+80%—20%
C952	283-0120-00			0.015 μ F	Cer	2500 V	+80%—20%
C953	283-0021-00			0.001 μ F	Cer	5000 V	
C955	281-0556-00			500 pF	Cer	10,000 V	
C957	281-0556-00			500 pF	Cer	10,000 V	
C961	283-0096-00			500 pF	Cer	20,000 V	
C963	283-0057-00			0.1 μ F	Cer	200 V	+80%—20%
C966	283-0120-00			0.015 μ F	Cer	2500 V	+80%—30%
C972	283-0079-00			0.01 μ F	Cer	250 V	
C976	283-0120-00			0.015 μ F	Cer	2500 V	+80%—20%
C979	283-0060-00			100 pF	Cer	200 V	5%
C985	285-0572-00			0.1 μ F	PTM	200 V	
C1105	283-0080-00			0.022 μ F	Cer	25 V	+80%—20%
C1111	285-0566-00			0.022 μ F	PTM	200 V	10%
C1112	290-0281-00			1500 μ F	Elect.	25 V	
C1141	285-0566-00			0.022 μ F	PTM	200 V	10%
C1142	290-0281-00			1500 μ F	Elect.	25 V	
C1171	285-0566-00			0.022 μ F	PTM	200 V	10%
C1172	290-0280-00	B010100	B099999	200 μ F	Elect.	150 V	
C1172	290-0018-00	B100000		200 μ F	Elect.	150 V	
C1191	283-0006-00			0.02 μ F	Cer	500 V	
C1200	285-0696-00	B010100	B069999	0.5 μ F	PTM	600 V	10%
C1200	285-0922-00	B070000		0.6 μ F	MT	150 V	
C1201	285-0566-00			0.022 μ F	PTM	200 V	10%
C1202	290-0280-00	B010100	B099999	200 μ F	Elect.	150 V	
C1202	290-0018-00	B100000		200 μ F	Elect.	150 V	
C1203	283-0008-00	XB120000		0.1 μ F	Cer	500 V	
C1204	290-0214-00	B010100	B099999	10 μ F	Elect.	250 V	
C1204	290-0405-00	B100000		10 μ F	Elect.	150 V	+50%—10%
C1211	285-0566-00			0.022 μ F	PTM	200 V	

¹Individual timing capacitors in this assembly must be ordered by the 9 digit part number, letter suffix and tolerance printed on the timing capacitor to be replaced.

Example:

F—
285-XXXX-XX

The letter suffix and the tolerance should be the same for all of the timing capacitors in the assembly.

CHASSIS (cont)

Ckt. No.	Tektronix Part No.	Serial/Model No. Eff	Disc	Description
Semiconductor Device, Diodes				
CR552	*152-0185-00			Silicon Replaceable by 1N4152
CR555	*152-0185-00			Silicon Replaceable by 1N4152
CR556	*152-0185-00			Silicon Replaceable by 1N4152
CR884	*152-0061-00			Silicon Tek Spec
CR911	*152-0185-00			Silicon Replaceable by 1N4152
CR940	152-0192-00	B010100	B099999	Rectifier VARO 7701-5X
CR940	*152-0429-00	B100000		Silicon Replaceable by VG-5X
CR952	152-0192-00	B010100	B099999	Rectifier VARO 7701-5X
CR952	*152-0429-00	B100000		Silicon Replaceable by VG-5X
CR953	152-0408-00			Silicon 10,000 V, 5 mA
CR955	152-0408-00			Silicon 10,000 V, 5 mA
CR957	152-0408-00			Silicon 10,000 V, 5 mA
CR1112A,B,C,D	152-0198-00			Silicon MR1032A (Motorola)
CR1142A,B,C,D	152-0198-00			Silicon MR1032A (Motorola)
CR1172A,B,C,D	152-0066-00			Silicon 1N3194
CR1202	152-0066-00			Silicon 1N3194
CR1212	152-0066-00			Silicon 1N3194
VR559	152-0217-00			Zener 1N756A 8.2 V, 0.4 W, 5%
VR963	152-0428-00			Zener 1N987B 400 mW, 120 V, 5%

Delay Line

DL301	*119-0168-01			Delay Line Assembly
-------	--------------	--	--	---------------------

Bulbs

DS75	150-0030-00			Neon, NE-2 V
DS175	150-0030-00			Neon, NE-2 V
DS400	150-0035-00			Neon, A1D
DS401	150-0035-00			Neon, A1D
DS530W	150-0035-00			Neon, A1D
DS596	150-0046-00			Incandescent #21070
DS597 ²	260-0717-00			
DS849	150-0035-00			Neon, A1D
DS973	150-0030-00			Neon, NE-2 V
DS974	150-0030-00			Neon, NE-2 V
DS975	150-0030-00			Neon, NE-2 V
DS1107	150-0045-00			Incandescent #685
DS1108	150-0047-00			Incandescent #CN8-398
DS1109	150-0047-00			Incandescent #CN8-398

Fuses

F937	159-0021-00			2A 3AG Fast-Blo
F1101	159-0021-00			2A 3AG Fast-Blo
F1102	159-0022-00			1A 3AG Fast-Blo
F1204	159-0028-00			1/4A 3AG Fast-Blo
F1437	159-0025-00			1/2A 3AG Fast-Blo

²Furnished as a unit with 5569.

CHASSIS (cont)

Ckt. No.	Tektronix Part No.	Serial/Model No. Eff	Disc	Description
----------	--------------------	----------------------	------	-------------

Connectors

J1	131-0955-00			BNC, receptacle, electrical
J101	131-0955-00			BNC, receptacle, electrical
J402	131-0274-00			BNC
J430	131-0955-00			BNC, receptacle, electrical
J529	131-0274-00			BNC
J579	131-0955-00			BNC, receptacle, electrical
J601	131-0955-00			BNC, receptacle, electrical
J729	131-0274-00			BNC

Inductors

L884	108-0254-00			600 μ H
L937	*108-0422-00			80 μ H
L980	*108-0321-00			Trace rotation
L989	*108-0295-00			Y Axis alignment
LR6F	*108-0282-00	XB130000		0.13 μ H (wound on a 30 Ω resistor)
LR106F	*108-0282-00	XB130000		0.13 μ H (wound on a 30 Ω resistor)
LR367	*108-0328-00			0.3 μ H (wound on a 220 Ω resistor)
LR377	*108-0328-00			0.3 μ H (wound on a 220 Ω resistor)

Transistors

Q364 } Q374 }	*153-0524-00			Silicon	NPN	TO-5 Tek Spec (matched pair)
Q884	*151-0124-00			Silicon	NPN	TO-5 Selected from 2N3119
Q894	*151-0124-00			Silicon	NPN	TO-5 Selected from 2N3119
Q930	*151-0140-00			Silicon	NPN	TO-3 Selected from 2N3055
Q1133	*151-0136-02			Silicon	NPN	TO-5 Replaceable by 2N3053
Q1137	*151-0140-00	B010100	B099999	Silicon	NPN	TO-3 Selected from 2N3055
Q1137	151-0337-00	B100000		Silicon	NPN	TO-3 Selected from 2N3055
Q1163	*151-0136-02			Silicon	NPN	TO-5 Replaceable by 2N3053
Q1167	*151-0140-00	B010100	B099999	Silicon	NPN	TO-3 Selected from 2N3055
Q1167	151-0337-00	B100000		Silicon	NPN	TO-3 Selected from 2N3055
Q1197	151-0149-00			Silicon	NPN	TO-66 2N3441

Resistors

Resistors are fixed, composition, $\pm 10\%$ unless otherwise indicated.

R2	315-0105-00			1 M Ω	$\frac{1}{4}$ W		5%
R3	317-0620-00			62 Ω	$\frac{1}{8}$ W		5%
R6C	322-0643-00			600 k Ω	$\frac{1}{4}$ W	Prec	1%
R6E	322-0644-00			666.6 k Ω	$\frac{1}{4}$ W	Prec	1%
R6F	315-0220-00	B010100	B129999X	22 Ω	$\frac{1}{4}$ W		5%

CHASSIS (cont)

Ckt. No.	Tektronix Part No.	Serial/Model No. Eff	Disc	Description
Resistors (cont)				
R7C	322-0620-00			800 k Ω 1/4 W Prec 1%
R7E	321-0618-00			250 k Ω 1/8 W Prec 1%
R7F	315-0470-00			47 Ω 1/4 W 5%
R8C	322-0621-01			900 k Ω 1/4 W Prec 1/2%
R8E	321-1389-01			111 k Ω 1/8 W Prec 1/2%
R8F	315-0560-00			56 Ω 1/4 W 5%
R9C	322-0624-01			990 k Ω 1/4 W Prec 1/2%
R9E	321-1289-01			10.1 k 1/8 W Prec 1/2%
R9F	315-0470-00			47 Ω 1/4 W 5%
R13	317-0220-00			22 Ω 1/8 W 5%
R30	311-0326-00			10 k Ω , Var
R31	315-0274-00			270 k Ω 1/4 W 5%
R40	*311-0994-00			2.5 k Ω , Var
R43E	315-0302-00			3 k Ω 1/4 W 5%
R44B	315-0133-00			13 k Ω 1/4 W 5%
R71	321-0111-00			140 Ω 1/8 W Prec 1%
R73	315-0102-00			1 k Ω 1/4 W 5%
R74	316-0103-00			10 k Ω 1/4 W
R75 ³	311-0385-00			250 Ω , Var
R76	321-0114-00			150 Ω 1/8 W Prec 1%
R77	316-0154-00			150 k Ω 1/4 W
R78	316-0106-00			10 M Ω 1/4 W
R81	321-0055-00			36.5 Ω 1/8 W Prec 1%
R90	311-0169-00			100 Ω , Var
R91	321-0017-00			14.7 Ω 1/8 W Prec 1%
R102	315-0105-00			1 M Ω 1/4 W 5%
R103	317-0620-00			62 Ω 1/8 W 5%
R106C	322-0643-00			600 k Ω 1/4 W Prec 1%
R106E	322-0644-00			666.6 k Ω 1/4 W Prec 1%
R106F	315-0220-00	B010100	B129999X	22 Ω 1/4 W 5%
R107C	322-0620-00			800 k Ω 1/4 W Prec 1%
R107E	321-0618-00			250 k Ω 1/8 W Prec 1%
R107F	315-0470-00			47 Ω 1/4 W 5%
R108C	322-0621-01			900 k Ω 1/4 W Prec 1/2%
R108E	321-1389-01			111 k Ω 1/8 W Prec 1/2%
R108F	315-0560-00			56 Ω 1/4 W 5%
R109C	322-0624-01			990 k Ω 1/4 W Prec 1/2%
R109E	321-1289-01			10.1 k Ω 1/8 W Prec 1/2%
R109F	315-0470-00			47 Ω 1/4 W 5%
R113	317-0220-00			22 Ω 1/8 W 5%
R130	311-0326-00			10 k Ω , Var
R131	315-0274-00			270 k Ω 1/4 W 5%
R140	*311-0994-00			2.5 k Ω , Var
R143E	315-0302-00			3 k Ω 1/4 W 5%
R144B	315-0133-00			13 k Ω 1/4 W 5%
R171	321-0111-00			140 Ω 1/8 W Prec 1%

³Furnished as a unit with S75.

CHASSIS (cont)

Ckt. No.	Tektronix Part No.	Serial/Model No. Eff	Disc	Description		
Resistors (cont)						
R173	315-0102-00			1 kΩ	1/4 W	5%
R174	316-0103-00			10 kΩ	1/4 W	
R175 ⁴	311-0385-00			250 Ω, Var		
R176	321-0114-00			150 Ω	1/8 W	Prec 1%
R177	316-0154-00			150 kΩ	1/4 W	
R178	316-0106-00			10 MΩ	1/4 W	
R181	321-0055-00			36.5 Ω	1/8 W	Prec 1%
R190	311-0169-00			100 Ω, Var		
R191	321-0017-00			14.7 Ω	1/8 W	Prec 1%
R364	*310-0623-00			650 Ω	4 W	Prec 1%
R365	316-0100-00			10 Ω	1/4 W	
R374	*310-0623-00			650 Ω	4 W	Prec 1%
R400	316-0154-00			150 kΩ	1/4 W	
R401	316-0154-00			150 kΩ	1/4 W	
R402	321-0097-00			100 Ω	1/8 W	Prec 1%
R403	321-0097-00			100 Ω	1/8 W	Prec 1%
R430	316-0100-00			10 Ω	1/4 W	
R433B	301-0914-00			910 kΩ	1/2 W	5%
R433C	301-0114-00			110 kΩ	1/2 W	5%
R435	315-0104-00			100 kΩ	1/4 W	5%
R436	315-0104-00			100 kΩ	1/4 W	5%
R460 ⁵	311-0553-00			10 kΩ, Var		
R528	316-0106-00			10 MΩ	1/4 W	
R530A	323-0400-00			143 kΩ	1/2 W	Prec 1%
R530B	323-0371-00			71.5 kΩ	1/2 W	Prec 1%
R530C	323-0371-00			71.5 kΩ	1/2 W	Prec 1%
R530D	323-0371-00			71.5 kΩ	1/2 W	Prec 1%
R530E	315-0335-00			3.3 MΩ	1/4 W	5%
R530F	325-0072-00			10 MΩ	1 W	Prec 1%
R530G	325-0077-00			11.5 MΩ	1 W	Prec 1%
R530H	325-0075-00			7.15 MΩ	1 W	Prec 1%
R530J	325-0073-00			3.57 MΩ	1 W	Prec 1%
R530K	323-0712-00	B010100	B139999	1.43 MΩ	1/2 W	Prec 1/2%
R530K	323-0712-07	B140000		1.43 MΩ	1/2 W	Prec 1/10%
R530L	323-0710-00	B010100	B139999	715 kΩ	1/2 W	Prec 1/2%
R530L	323-0711-00	B140000		715 kΩ	1/2 W	Prec 1/10%
R530M	323-0710-00	B010100	B139999	715 kΩ	1/2 W	Prec 1/2%
R530M	323-0711-00	B140000		715 kΩ	1/2 W	Prec 1/10%
R530N	323-0711-00			715 kΩ	1/2 W	Prec 1/10%
R530W	316-0154-00			150 kΩ	1/4 W	
R530X	315-0272-00			2.7 kΩ	1/4 W	5%
R530Y ⁶	311-0554-00			20 kΩ, Var		
R532	301-0221-00			220 Ω	1/2 W	5%

⁴Furnished as a unit with S175.

⁵Furnished as a unit with R551.

⁶Furnished as a unit with S530Y.

CHASSIS (cont)

Ckt. No.	Tektronix Part No.	Serial/Model No. Eff	No. Disc	Description		
Resistors (cont)						
R551 [†]	311-0553-00		10 kΩ, Var			
R552	323-0381-00		90.9 kΩ	1/2 W	Prec	1%
R555	311-0191-00		10 kΩ, Var			
R558	323-0353-00		46.4 kΩ	1/2 W	Prec	1%
R569	302-0104-00		100 kΩ	1/2 W		
R601	316-0100-00		10 Ω	1/4 W		
R613B	301-0914-00		910 kΩ	1/2 W		5%
R613C	301-0114-00		110 kΩ	1/2 W		5%
R615	315-0104-00		100 kΩ	1/4 W		5%
R616	315-0104-00		100 kΩ	1/4 W		5%
R660	311-0555-00		10 kΩ, Var			
R740A	323-0400-00		143 kΩ	1/2 W	Prec	1%
R740B	323-0371-00		71.5 kΩ	1/2 W	Prec	1%
R740C	323-0371-00		71.5 kΩ	1/2 W	Prec	1%
R740D	323-0371-00		71.5 kΩ	1/2 W	Prec	1%
R740E	315-0335-00		3.3 MΩ	1/4 W		5%
R740F	325-0072-00		10 MΩ	1 W	Prec	1%
R740G	325-0077-00		11.5 MΩ	1 W	Prec	1%
R740H	325-0075-00		7.15 MΩ	1 W	Prec	1%
R740J	325-0073-00		3.57 MΩ	1 W	Prec	1%
R740K	323-0712-00		1.43 MΩ	1/2 W	Prec	1/2%
R740L	323-0710-00		715 kΩ	1/2 W	Prec	1/2%
R740M	323-0710-00		715 kΩ	1/2 W	Prec	1/2%
R740N	323-0711-00		715 kΩ	1/2 W	Prec	1/10%
R740P	315-0332-00		3.3 kΩ	1/4 W		5%
R740X	315-0272-00		2.7 kΩ	1/4 W		5%
R740Y [‡]	311-0554-00		20 kΩ, Var			
R760	311-0386-00		2 kΩ, Var			
R801	321-0286-00		9.31 kΩ	1/8 W	Prec	1%
R802	321-0286-00		9.31 kΩ	1/8 W	Prec	1%
R805A,B	311-0542-01		10 kΩ, Var 50 kΩ, Var			
R808	315-0822-00		8.2 kΩ	1/4 W		5%
R849	316-0154-00		150 kΩ	1/4 W		
R884	308-0363-00		3 kΩ	8 W	WW	5%
R886	305-0471-00		470 Ω	2 W		5%
R887	308-0092-00		4.5 kΩ	5 W	WW	5%
R894	308-0363-00		3 kΩ	8 W	WW	5%
R902	301-0105-00		1 MΩ	1/2 W		5%

[†]Furnished as a unit with R460.

[‡]Furnished as a unit with 5740Y.

CHASSIS (cont)

Ckt. No.	Tektronix Part No.	Serial/Model No. Eff	Disc	Description	
Resistors (cont)					
R903	301-0305-00			3 M Ω	1/2 W 5%
R904	301-0305-00			3 M Ω	1/2 W 5%
R905	301-0305-00			3 M Ω	1/2 W 5%
R906	301-0305-00			3 M Ω	1/2 W 5%
R907	301-0305-00			3 M Ω	1/2 W 5%
R908	301-0305-00			3 M Ω	1/2 W 5%
R909	301-0305-00			3 M Ω	1/2 W 5%
R910	301-0305-00			3 M Ω	1/2 W 5%
R911	315-0204-00			200 k Ω	1/4 W 5%
R940	311-0657-00			2 M Ω , Var	
R941	301-0206-00			20 M Ω	1/2 W 5%
R942	301-0103-00			10 k Ω	1/2 W 5%
R944	301-0106-00			10 M Ω	1/2 W 5%
R945	301-0106-00			10 M Ω	1/2 W 5%
R946	301-0106-00			10 M Ω	1/2 W 5%
R947	301-0106-00			10 M Ω	1/2 W 5%
R948	301-0106-00			10 M Ω	1/2 W 5%
R949	316-0105-00			1 M Ω	1/4 W
R951	308-0588-00			12 Ω	1/2 W WW 1%
R956	301-0103-00			10 k Ω	1/2 W 5%
R961	316-0105-00			1 M Ω	1/4 W
R962	316-0105-00			1 M Ω	1/4 W
R963	301-0205-00			2 M Ω	1/2 W 5%
R964	301-0335-00			3.3 M Ω	1/2 W 5%
R965	301-0335-00			3.3 M Ω	1/2 W 5%
R966	301-0335-00			3.3 M Ω	1/2 W 5%
R967	311-0254-00			5 M Ω , Var	
R968	301-0155-00			1.5 M Ω	1/2 W 5%
R969	301-0106-00			10 M Ω	1/2 W 5%
R971	315-0332-00			3.3 k Ω	1/4 W 5%
R972	301-0682-00			6.8 k Ω	1/2 W 5%
R975	301-0103-00			10 k Ω	1/2 W 5%
R976	316-0470-00			47 Ω	1/4 W
R979	315-0471-00			470 Ω	1/4 W 5%
R980	311-0458-00			5 k Ω , Var	
R985	311-0157-00	B010100	B069999	100 k Ω , Var	
R985	311-1146-00	B070000		100 k Ω , Var	
R989	311-0458-00			5 k Ω , Var	
R1003	316-0123-00			12 k Ω	1/4 W
R1005	311-0511-00			10 k Ω , Var	
R1104	316-0153-00			15 k Ω	1/4 W
R1105	316-0472-00			4.7 k Ω	1/4 W

CHASSIS (cont)

Ckt. No.	Tektronix Part No.	Serial/Model No. Eff	Disc	Description		
Resistors (cont)						
R1106	316-0102-00		1 k Ω	1/4 W		
R1107	316-0330-00		33 Ω	1/4 W		
R1108	311-0548-00		25 Ω , Var			
R1112	316-0103-00		10 k Ω	1/4 W		
R1137	308-0362-00		50 Ω	10 W	WW	5%
R1142	316-0103-00		10 k Ω	1/4 W		
R1167	308-0362-00		50 Ω	10 W	WW	5%
R1172	316-0104-00		100 k Ω	1/4 W		
R1191	303-0153-00		100 Ω	10 W	WW	5%
R1197	308-0153-00		100 Ω	10 W	WW	5%
R1202	316-0104-00		100 k Ω	1/4 W		
R1204	302-0270-00		27 Ω	1/2 W		
R1275	322-0655-00		180 Ω	1/4 W	Prec	1/4%
R1276	321-0702-00		30 Ω	1/8 W	Prec	1/4%
R1277	321-0704-00		60 Ω	1/8 W	Prec	1/2%

Switches

Wired or Unwired				
S1	260-1168-00	Lever		AC-GND-DC
S5	260-0720-03	Rotary		CH 1 VOLTS/DIV
S75 ⁹	311-0385-00			CH 1 CAL
S101	260-1168-00	Lever		AC-GND-DC
S105	260-0720-03	Rotary		CH 2 VOLTS/DIV
S175 ¹⁰	311-0385-00			CH 2 CAL
S230A } S230B }	Wired *262-0727-01	Rotary		MODE TRIGGER
S230A } S230B }	260-0695-01	Rotary		MODE TRIGGER
S330	260-0688-00	Push		TRACE FINDER
S430	260-0698-01	Lever		A SOURCE
S435	260-0700-00	Lever		A COUPLING
S455	260-0472-00	Lever		A SLOPE
S530A,B	Wired *262-0724-01	Rotary		A AND B TIME/DIV
S530A,B	260-0694-00	Rotary		A AND B TIME/DIV

⁹Furnished as a unit with R75.

¹⁰Furnished as a unit with R175.

CHASSIS (cont)

Ckt. No.	Tektronix Part No.	Serial/Model No. Eff	Disc	Description
Switches (cont)				
S530Y ¹¹	311-0554-00			
S555	260-0697-01			Rotary
S569 ¹²	260-0717-00			Push
S580	260-1149-00			Lever
				A SWEEP LENGTH RESET A SWEEP MODE
S610	260-0698-01			Lever
S615	260-0700-00			Lever
S635	260-0587-00			Lever
S655	260-0472-00			Lever
				B SOURCE B COUPLING B SWEEP MODE B SLOPE
S740Y ¹³	311-0554-00			
S801A } S801B }	260-1197-00	B010100	B059999	Rotary
S801A } S801B }	260-1197-01	B060000		Rotary
				B VARIABLE CAL HORIZ DISPLAY MAG HORIZ DISPLAY MAG
S1101	260-0834-00			Toggle
S1102 ¹⁴				
S1103 ¹⁴				
S1275	260-0447-00			Slide
				POWER CALIBRATOR
Thermal Cut-Out				
TK1101	260-0638-00			Opens at 75°C ±3°
Transformers				
T930	*120-0471-00			H. V. Power
T1101	*120-0549-00			L. V. Power
Electron Tube				
V979	*154-0630-00	B010100	B029999	CRT Standard Phosphor
V979	*154-0630-05	B030000	B069999	CRT Standard Phosphor
V979	*154-0630-10	B070000		CRT Standard Phosphor
Optional Phosphors				
V979	*154-0630-07			P2
V979	*154-0630-08			P7
V979	*154-0630-09			P11

¹¹Furnished as a unit with R530Y.¹²Furnished as a unit with D5597.¹³Furnished as a unit with R740Y.¹⁴See Mechanical Parts List, Line Voltage Selector Body.

A1 VERTICAL PREAMP Circuit Board Assembly

Ckt. No.	Tektronix Part No.	Serial/Model No. Eff	Disc	Description
	*670-0419-08	B010100	B109999	Complete Board
	*670-0419-11	B110000		Complete Board

Capacitors

Tolerance $\pm 20\%$ unless otherwise indicated.

C17	281-0064-00	0.25-1.5 pF, Var	Tub.		
C18	283-0077-00	330 pF	Cer	500 V	5%
C20	281-0603-00	39 pF	Cer	500 V	5%
C23	283-0081-00	0.1 μ F	Cer	25 V	+80%—20%
C24	290-0177-00	1 μ F	Elect.	50 V	
C30	283-0080-00	0.022 μ F	Cer	25 V	+80%—20%
C38	283-0142-00	0.0027 μ F (nominal value)	Selected		
C39	281-0523-00	100 pF	Cer	350 V	
C43A	281-0081-00	1.8-13 pF, Var	Air		
C43B	281-0572-00	6.8 pF	Cer	500 V	± 0.5 pF
C43C	281-0081-00	1.8-13 pF, Var	Air		
C43D	281-0510-00	22 pF	Cer	500 V	
C44A		Selected			
C44C	281-0080-00	1.7-11 pF, Var	Air		
C45A	281-0080-00	1.7-11 pF, Var	Air		
C49	281-0081-00	1.8-13 pF, Var	Air		
C53	290-0267-00	1 μ F	Elect.	35 V	
C54	281-0077-00	1.3-5.4 pF, Var	Air		
C64	283-0078-00	0.001 μ F	Cer	500 V	
C84	283-0032-00	470 pF	Cer	500 V	5%
C94	283-0032-00	470 pF	Cer	500 V	5%
C95	283-0080-00	0.022 μ F	Cer	25 V	+80%—20%
C96	290-0134-00	22 μ F	Elect.	15 V	
C97	290-0134-00	22 μ F	Elect.	15 V	
C98	283-0092-00	0.03 μ F	Cer	200 V	+80%—20%
C99	283-0092-00	0.03 μ F	Cer	200 V	+80%—20%
C117	281-0064-00	0.25-1.5 pF, Var	Tub.		
C118	283-0077-00	330 pF	Cer	500 V	5%
C120	281-0603-00	39 pF	Cer	500 V	5%
C123	283-0081-00	0.1 μ F	Cer	25 V	+80%—20%
C124	290-0177-00	1 μ F	Elect.	50 V	
C130	283-0080-00	0.022 μ F	Cer	25 V	+80%—20%
C138	283-0142-00	0.0027 μ F (nominal value)	Selected		
C139	281-0523-00	100 pF	Cer	350 V	
C143A	281-0081-00	1.8-13 pF, Var	Air		
C143B	281-0572-00	6.8 pF	Cer	500 V	± 0.5 pF
C143C	281-0081-00	1.8-13 pF, Var	Air		
C143D	281-0510-00	22 pF	Cer	500 V	

A1 VERTICAL PREAMP Circuit Board Assembly (cont)

Ckt. No.	Tektronix Part No.	Serial/Model No. Eff	Disc	Description			
Capacitors (cont)							
C144A	Selected						
C144C	281-0080-00			1.7-11 pF, Var	Air		
C145A	281-0080-00			1.7-11 pF, Var	Air		
C149	281-0081-00			1.8-13 pF, Var	Air		
C153	290-0267-00			1 μ F	Elect.	35 V	
C154	281-0077-00			1.3-5.4 pF, Var	Air		
C159	281-0504-00			10 pF	Cer	500 V	10%
C184	283-0032-00			470 pF	Cer	500 V	5%
C194	283-0032-00			470 pF	Cer	500 V	5%
C197	290-0134-00			22 μ F	Elect.	15 V	
C198	290-0134-00			22 μ F	Elect.	15 V	
C199	283-0080-00			0.022 μ F	Cer	25 V	+80%—20%
C214	281-0510-00			22 pF	Cer	500 V	
C218	285-0698-00			0.0082 μ F	PTM	100 V	5%
C224	281-0510-00			22 pF	Cer	500 V	
C241	283-0060-00			100 pF	Cer	200 V	5%
C253	283-0081-00			0.1 μ F	Cer	25 V	+80%—20%
C261	283-0060-00			100 pF	Cer	200 V	5%
C262	281-0572-00			6.8 pF	Cer	500 V	10%
C263	281-0081-00			1.8-13 pF, Var	Air		
C264	281-0512-00			27 pF (nominal value)	Selected		
C265	281-0081-00			1.8-13 pF, Var	Air		
C266	281-0604-00			2.2 pF	Cer	500 V	± 0.25 pF
C288	281-0505-00			12 pF	Cer	500 V	10%
C289	281-0593-00			3.9 pF	Cer		10%
C293	283-0081-00			0.1 μ F	Cer	25 V	+80%—20%
C297	283-0081-00			0.1 μ F	Cer	25 V	+80%—20%
C298	281-0505-00			12 pF	Cer	500 V	10%
C299	283-0081-00			0.1 μ F	Cer	25 V	+80%—20%

Semiconductor Device, Diodes

CR18	*152-0324-00	Silicon	Tek Spec
CR34	*152-0185-00	Silicon	Replaceable by 1N4152
CR35	*152-0185-00	Silicon	Replaceable by 1N4152
CR36	*152-0185-00	Silicon	Replaceable by 1N4152
CR37	*152-0185-00	Silicon	Replaceable by 1N4152
CR52	*152-0185-00	Silicon	Replaceable by 1N4152
CR58	*152-0185-00	Silicon	Replaceable by 1N4152
CR118	*152-0324-00	Silicon	Tek Spec
CR134	*152-0185-00	Silicon	Replaceable by 1N4152
CR135	*152-0185-00	Silicon	Replaceable by 1N4152

A1 VERTICAL PREAMP Circuit Board Assembly (cont)

Ckt. No.	Tektronix Part No.	Serial/Model No. Eff	Disc	Description
Semiconductor Device, Diodes (cont)				
CR136	*152-0185-00			Silicon Replaceable by 1N4152
CR137	*152-0185-00			Silicon Replaceable by 1N4152
CR152	*152-0185-00			Silicon Replaceable by 1N4152
CR201	152-0141-02			Silicon 1N4152
CR202	152-0141-02			Silicon 1N4152
CR203	152-0141-02			Silicon 1N4152
CR204	152-0141-02			Silicon 1N4152
CR206	152-0141-02			Silicon 1N4152
CR207	152-0141-02			Silicon 1N4152
CR208	152-0141-02			Silicon 1N4152
CR209	152-0141-02			Silicon 1N4152
CR213	*152-0185-00			Silicon Replaceable by 1N4152
CR218	152-0141-02			Silicon 1N4152
CR223	*152-0185-00			Silicon Replaceable by 1N4152
CR228	152-0141-02			Silicon 1N4152
CR231	*152-0185-00			Silicon Replaceable by 1N4152
CR233	152-0008-00			Germanium
CR235	*152-0185-00			Silicon Replaceable by 1N4152
VR53	152-0166-00			Zener 1N753A 6.2 V, 0.4 W, 5%
VR153	152-0166-00			Zener 1N753A 6.2 V, 0.4 W, 5%

Inductors

L23	*108-0443-00			Core, ferramic suppressor
L24	276-0528-00	XB110000		25 μ H
L43A	*114-0170-00			0.15-0.25 μ H, Var Core 276-0506-00
L44A	*108-0182-00			0.3 μ H
L45A	*108-0170-01			0.5 μ H
L84	276-0528-00			Core, ferramic suppressor
L94	276-0528-00		Core, ferramic suppressor	
L95	276-0507-00		Core, ferramic suppressor	
L123	*108-0443-00			25 μ H
L143A	*114-0170-00			0.15-0.25 μ H, Var Core 276-0506-00
L144A	*108-0182-00			0.3 μ H
L145A	*108-0170-01			0.5 μ H
L199	276-0507-00			Core, ferramic suppressor
L201	276-0528-00			Core, ferramic suppressor
L202	276-0528-00			Core, ferramic suppressor
L203	276-0528-00			Core, ferramic suppressor
L204	276-0528-00			Core, ferramic suppressor
L206	276-0528-00			Core, ferramic suppressor
L209	276-0528-00			Core, ferramic suppressor
LR287	*108-0329-00			2.5 μ H (wound on a 75 Ω resistor)

A1 VERTICAL PREAMP Circuit Board Assembly (cont)

Ckt. No.	Tektronix Part No.	Serial/Model No. Eff	Disc	Description		
Transistors						
Q23	*151-1011-00			Silicon	FET	Dual, Tek Spec
Q33 } Q34 } Q43 ¹⁵ } Q43	*153-0552-00			Silicon		Matched assembly
	*153-0583-00	B010100	B069999	Silicon	NPN	TO-18 2N3563 (matched pair)
	151-0225-00	B070000	B079999	Silicon	NPN	TO-18 2N3563
Q43	*151-0269-00	B080000		Silicon	NPN	TO-106 Selected from SE 3005
Q54	151-0221-00			Silicon	PNP	TO-18 2N4258
Q63	151-0220-00			Silicon	PNP	TO-18 2N4122
Q84	151-0221-00			Silicon	PNP	TO-18 2N4258
Q94	151-0221-00			Silicon	PNP	TO-18 2N4258
Q123	*151-1011-00			Silicon	FET	Dual, Tek Spec
Q133 } Q134 } Q143 ¹⁶ } Q143	*153-0552-00			Silicon		Matched assembly
	*153-0583-00	B010100	B069999	Silicon	NPN	TO-18 2N3563 (matched pair)
	151-0225-00	B070000	B079999	Silicon	NPN	TO-18 2N3563
Q143	*151-0269-00	B080000		Silicon	NPN	TO-106 Selected from SE 3005
Q154	151-0221-00			Silicon	PNP	TO-18 2N4258
Q184	151-0221-00			Silicon	PNP	TO-18 2N4258
Q194	151-0221-00			Silicon	PNP	TO-18 2N4258
Q215	*151-0190-01			Silicon	NPN	TO-106 Tek Spec
Q225	*151-0190-01			Silicon	NPN	TO-106 Tek Spec
Q234	*151-0190-01			Silicon	NPN	TO-106 Tek Spec
Q244	151-0223-00			Silicon	NPN	TO-18 2N4275
Q253	151-0220-00			Silicon	PNP	TO-18 2N4122
Q284	*151-0160-00			Silicon	NPN	TO-5 Selected from 2N3137
Q294	*151-0160-00			Silicon	NPN	TO-5 Selected from 2N3137

ResistorsResistors are fixed, composition, $\pm 10\%$ unless otherwise indicated.

R16	315-0112-00	1.1 k Ω	$\frac{1}{4}$ W		5%
R17	322-0630-00	980 k Ω	$\frac{1}{4}$ W	Prec	1%
R18	316-0105-00	1 M Ω	$\frac{1}{4}$ W		
R19	315-0182-00	1.8 k Ω	$\frac{1}{4}$ W		5%
R20	321-0318-00	20 k Ω	$\frac{1}{8}$ W	Prec	1%
R21	315-0101-00	100 Ω	$\frac{1}{4}$ W		5%
R23	321-0163-00	487 Ω	$\frac{1}{8}$ W	Prec	1%
R24	321-0237-00	2.87 k Ω	$\frac{1}{8}$ W	Prec	1%
R25	321-0302-00	13.7 k Ω	$\frac{1}{8}$ W	Prec	1%
R26	321-0302-00	13.7 k Ω	$\frac{1}{8}$ W	Prec	1%
R32	315-0102-00	1 k Ω	$\frac{1}{4}$ W		5%
R33	321-0165-00	511 Ω	$\frac{1}{8}$ W	Prec	1%
R34	316-0105-00	1 M Ω	$\frac{1}{4}$ W		
R36	321-0339-00	33.2 k Ω	$\frac{1}{8}$ W	Prec	1%

¹⁵Furnished as a matched pair with Q143.¹⁶Furnished as a matched pair with Q43.

A1 VERTICAL PREAMP Circuit Board Assembly (cont)

Ckt. No.	Tektronix Part No.	Serial/Model No. Eff	Disc	Description		
Resistors (cont)						
R37	315-0274-00			270 k Ω	1/4 W	5%
R38	321-0210-00			1.5 k Ω	1/8 W	Prec 1%
R39	316-0470-00			47 Ω	1/4 W	
R41	321-0281-00			8.25 k Ω	1/8 W	Prec 1%
R43A	321-0078-00			63.4 Ω	1/8 W	Prec 1%
R43C	311-0442-00	B010100	B139999	250 Ω , Var		
R43C	311-1223-00	B140000		250 Ω , Var		
R44A	321-0124-00			191 Ω	1/8 W	Prec 1%
R44C	311-0462-00	B010100	B139999	1 k Ω , Var		
R44C	311-1225-00	B140000		1 k Ω , Var		
R45A	321-0151-00			365 Ω	1/8 W	Prec 1%
R46	321-0136-00			255 Ω	1/8 W	Prec 1%
R47	321-0237-00			2.87 k Ω	1/8 W	Prec 1%
R48	321-0212-00			1.58 k Ω	1/8 W	Prec 1%
R49	311-0462-00	B010100	B139999	1 k Ω , Var		
R49	311-1225-00	B140000		1 k Ω , Var		
R50	321-0136-00			255 Ω	1/8 W	Prec 1%
R51	316-0680-00			68 Ω	1/4 W	
R52	321-0216-00			1.74 k Ω	1/8 W	Prec 1%
R54	316-0680-00			68 Ω	1/4 W	
R55	311-0480-00	B010100	B139999	500 Ω , Var		
R55	311-1224-00	B140000		500 Ω , Var		
R56	315-0752-00			7.5 k Ω	1/4 W	5%
R58	301-0112-00			1.1 k Ω	1/2 W	5%
R59	315-0331-00			330 Ω	1/4 W	5%
R60	311-0465-00	B010100	B139999	100 k Ω , Var		
R60	311-1235-00	B140000		100 k Ω , Var		
R61	315-0153-00			15 k Ω	1/4 W	5%
R63	301-0122-00			1.2 k Ω	1/2 W	5%
R64	315-0331-00			330 Ω	1/4 W	5%
R66	321-0083-00			71.5 Ω	1/8 W	Prec 1%
R83	321-0207-00			1.4 k Ω	1/8 W	Prec 1%
R84	315-0331-00			330 Ω	1/4 W	5%
R93	321-0207-00			1.4 k Ω	1/8 W	Prec 1%
R94	315-0331-00			330 Ω	1/4 W	5%
R96	315-0100-00			10 Ω	1/4 W	5%
R97	315-0100-00			10 Ω	1/4 W	5%
R116	315-0112-00			1.1 k Ω	1/4 W	5%
R117	322-0630-00			980 k Ω	1/4 W	Prec 1%
R118	316-0105-00			1 M Ω	1/4 W	
R119	315-0182-00			1.8 k Ω	1/4 W	5%
R120	321-0318-00			20 k Ω	1/8 W	Prec 1%
R121	315-0101-00			100 Ω	1/4 W	5%

A1 VERTICAL PREAMP Circuit Board Assembly (cont)

Ckt. No.	Tektronix Part No.	Serial/Model No. Eff	Disc	Description		
Resistors (cont)						
R123	321-0163-00			487 Ω	$\frac{1}{8}$ W	Prec 1%
R124	321-0237-00			2.87 k Ω	$\frac{1}{8}$ W	Prec 1%
R125	321-0302-00			13.7 k Ω	$\frac{1}{8}$ W	Prec 1%
R126	321-0302-00			13.7 k Ω	$\frac{1}{8}$ W	Prec 1%
R132	315-0102-00			1 k Ω	$\frac{1}{4}$ W	5%
R133	321-0165-00			511 Ω	$\frac{1}{8}$ W	Prec 1%
R134	316-0105-00			1 M Ω	$\frac{1}{4}$ W	
R136	321-0339-00			33.2 k Ω	$\frac{1}{8}$ W	Prec 1%
R137	315-0274-00			270 k Ω	$\frac{1}{4}$ W	5%
R138	321-0210-00			1.5 k Ω	$\frac{1}{8}$ W	Prec 1%
R139	316-0470-00			47 Ω	$\frac{1}{4}$ W	
R141	321-0281-00			8.25 k Ω	$\frac{1}{8}$ W	Prec 1%
R143A	321-0078-00			63.4 Ω	$\frac{1}{8}$ W	Prec 1%
R143C	311-0442-00	B010100	B139999	250 Ω , Var		
R143C	311-1223-00	B140000		250 Ω , Var		
R144A	321-0124-00			191 Ω	$\frac{1}{8}$ W	Prec 1%
R144C	311-0462-00	B010100	B139999	1 k Ω , Var		
R144C	311-1225-00	B140000		1 k Ω , Var		
R145A	321-0151-00			365 Ω	$\frac{1}{8}$ W	Prec 1%
R146	321-0136-00			255 Ω	$\frac{1}{8}$ W	Prec 1%
R147	321-0237-00			2.87 k Ω	$\frac{1}{8}$ W	Prec 1%
R148	321-0212-00			1.58 k Ω	$\frac{1}{8}$ W	Prec 1%
R149	311-0462-00	B010100	B139999	1 k Ω , Var		
R149	311-1225-00	B140000		1 k Ω , Var		
R150	321-0136-00			255 Ω	$\frac{1}{8}$ W	Prec 1%
R151	316-0580-00			68 Ω	$\frac{1}{4}$ W	
R152	321-0216-00			1.74 k Ω	$\frac{1}{8}$ W	Prec 1%
R154	316-0680-00			68 Ω	$\frac{1}{4}$ W	
R155	311-0480-00	B010100	B139999	500 Ω , Var		
R155	311-1224-00	B140000		500 Ω , Var		
R156	315-0752-00			7.5 k Ω	$\frac{1}{4}$ W	5%
R158	301-0122-00			1.2 k Ω	$\frac{1}{2}$ W	5%
R159	315-0331-00			330 Ω	$\frac{1}{4}$ W	5%
R183	321-0207-00			1.4 k Ω	$\frac{1}{8}$ W	Prec 1%
R184	315-0331-00			330 Ω	$\frac{1}{4}$ W	5%
R193	321-0207-00			1.4 k Ω	$\frac{1}{8}$ W	Prec 1%
R194	315-0331-00			330 Ω	$\frac{1}{4}$ W	5%
R195	315-0473-00			47 k Ω	(nominal value) Selected	
R197	315-0100-00			10 Ω	$\frac{1}{4}$ W	5%
R199	315-0100-00			10 Ω	$\frac{1}{4}$ W	5%
R211	315-0200-00			20 Ω	$\frac{1}{4}$ W	5%

A1 VERTICAL PREAMP Circuit Board Assembly (cont)

Ckt. No.	Tektronix Part No.	Serial/Model No. Eff	Disc	Description		
Resistors (cont)						
R212	321-0175-00			649 Ω	$\frac{1}{8}$ W	Prec 1%
R213	321-0123-00			187 Ω	$\frac{1}{8}$ W	Prec 1%
R214	321-0193-00			1 k Ω	$\frac{1}{8}$ W	Prec 1%
R215	321-0229-00			2.37 k Ω	$\frac{1}{8}$ W	Prec 1%
R216	315-0332-00			3.3 k Ω	$\frac{1}{4}$ W	5%
R217	321-0113-00			147 Ω	$\frac{1}{8}$ W	Prec 1%
R218	321-0125-00			196 Ω	$\frac{1}{8}$ W	Prec 1%
R221	315-0200-00			20 Ω	$\frac{1}{4}$ W	5%
R222	321-0175-00			649 Ω	$\frac{1}{8}$ W	Prec 1%
R223	321-0123-00			187 Ω	$\frac{1}{8}$ W	Prec 1%
R224	321-0193-00			1 k Ω	$\frac{1}{8}$ W	Prec 1%
R225	321-0229-00			2.37 k Ω	$\frac{1}{8}$ W	Prec 1%
R227	321-0113-00			147 Ω	$\frac{1}{8}$ W	Prec 1%
R228	321-0125-00			196 Ω	$\frac{1}{8}$ W	Prec 1%
R232	315-0153-00			15 k Ω	$\frac{1}{4}$ W	5%
R233	315-0332-00			3.3 k Ω	$\frac{1}{4}$ W	5%
R234	321-0081-00			68.1 Ω	$\frac{1}{8}$ W	Prec 1%
R235	315-0102-00			1 k Ω	$\frac{1}{4}$ W	5%
R241	315-0473-00			47 k Ω	$\frac{1}{4}$ W	5%
R244	315-0392-00			3.9 k Ω	$\frac{1}{4}$ W	5%
R245	315-0222-00			2.2 k Ω	$\frac{1}{4}$ W	5%
R253	315-0102-00			1 k Ω	$\frac{1}{4}$ W	5%
R260	321-0179-00			715 Ω	$\frac{1}{8}$ W	Prec 1%
R261	315-0363-00			36 k Ω	$\frac{1}{4}$ W	5%
R262	321-0235-00			2.74 k Ω	$\frac{1}{8}$ W	Prec 1%
R264	321-0260-00			4.99 k Ω	$\frac{1}{8}$ W	Prec 1%
R265	321-0205-00			1.33 k Ω	$\frac{1}{8}$ W	Prec 1%
R267	321-0164-00			499 Ω	$\frac{1}{8}$ W	Prec 1%
R268	321-0117-00			162 Ω	$\frac{1}{8}$ W	Prec 1%
R269	321-0117-00			162 Ω	$\frac{1}{8}$ W	Prec 1%
R270	321-0179-00			715 Ω	$\frac{1}{8}$ W	Prec 1%
R277	321-0164-00			499 Ω	$\frac{1}{8}$ W	Prec 1%
R278	321-0117-00			162 Ω	$\frac{1}{8}$ W	Prec 1%
R279	321-0117-00			162 Ω	$\frac{1}{8}$ W	Prec 1%
R284	321-0161-00			464 Ω	$\frac{1}{8}$ W	Prec 1%
R285	311-0480-00	B010100	B139999	500 Ω , Var		
R285	311-1224-00	B140000		500 Ω , Var		
R286	321-0197-00			1.1 k Ω	$\frac{1}{8}$ W	Prec 1%
R288	321-0037-00			78.7 Ω	$\frac{1}{8}$ W	Prec 1%
R289	315-0331-00			330 Ω	$\frac{1}{4}$ W	5%
R291	315-0221-00			220 Ω	$\frac{1}{4}$ W	5%

A1 VERTICAL PREAMP Circuit Board Assembly (cont)

Ckt. No.	Tektronix Part No.	Serial/Model No. Eff	Disc	Description		
Resistors (cont)						
R292	323-0099-00		105 Ω	1/2 W	Prec	1%
R294	315-0752-00		7.5 kΩ	1/4 W		5%
R295	315-0621-00		620 Ω	1/4 W		5%
R298	321-0087-00		78.7 Ω	1/8 W	Prec	1%
R299	315-0120-00		12 Ω	1/4 W		5%

Switch

Wired or Unwired				
S195	260-0447-00	Slide	INVERT	

Transformers

T195	276-0576-00	Core, toroid ferrite
T241	*120-0384-00	Toroid, 10 turns-5 turns

A2 VERTICAL OUTPUT Circuit Board Assembly

*670-0416-02	B010100	B049999	Complete Board
*670-0416-04	B050000		Complete Board

Capacitors

Tolerance ±20% unless otherwise indicated.

C301	281-0503-00	8 pF	Cer	500 V	±0.5 pF
C302	281-0503-00	8 pF	Cer	500 V	±0.5 pF
C303	281-0572-00	6.8 pF	Cer	500 V	±0.5 pF
C306	283-0080-00	0.022 μF	Cer	25 V	+80%—20%
C311	281-0503-00	8 pF	Cer	500 V	±0.5 pF
C312	281-0503-00	8 pF	Cer	500 V	±0.5 pF
C313	281-0572-00	6.8 pF	Cer	500 V	±0.5 pF
C322	283-0080-00	0.022 μF	Cer	25 V	+80%—20%
C326	281-0504-00	10 pF	Cer	500 V	10%
C327	281-0572-00	6.8 pF	Cer	500 V	±0.5 pF
C328	281-0081-00	1.8-13 pF, Var	Air		
C331	283-0080-00	0.022 μF	Cer	25 V	+80%—20%
C336	281-0081-00	1.8-13 pF, Var	Air		
C340	281-0662-00	10 pF	Cer	500 V	±0.5 pF
C342	281-0572-00	6.8 pF	Cer	500 V	10%
C344	283-0077-00	330 pF	Cer	500 V	5%
C347	281-0603-00	39 pF	Cer	500 V	5%
C354	283-0077-00	330 pF	Cer	500 V	5%
C361	283-0078-00	0.001 μF	Cer	500 V	
C371	283-0078-00	0.001 μF	Cer	500 V	

A2 VERTICAL OUTPUT Circuit Board Assembly (cont)

Ckt. No.	Tektronix Part No.	Serial/Model No. Eff	Disc	Description
----------	--------------------	----------------------	------	-------------

Semiconductor Device, Diodes

CR339	*152-0185-00		Silicon	Replaceable by 1N4152
VR344	152-0278-00		Zener	1N4372A 3 V, 0.4 W, 5%
VR354	152-0278-00		Zener	1N4372A 3 V, 0.4 W, 5%

Inductors

L301	*108-0220-00		0.15 μ H	
L302	*108-0277-00		0.07 μ H	
L311	*108-0220-00		0.15 μ H	
L361	276-0507-00		Core, ferramic suppressor	
L371	276-0507-00		Core, ferramic suppressor	

Transistors

Q304	151-0223-00		Silicon	NPN	TO-18	2N4275
Q314	151-0223-00		Silicon	NPN	TO-18	2N4275
Q324	*151-0120-01		Silicon	NPN	TO-18	Tek Spec
Q334	*151-0120-01		Silicon	NPN	TO-18	Tek Spec
Q344	*151-0127-00		Silicon	NPN	TO-18	Selected from 2N2369
Q354	*151-0127-00		Silicon	NPN	TO-18	Selected from 2N2369

Resistors

Resistors are fixed, composition, $\pm 10\%$ unless otherwise indicated.

R303	321-0091-00		86.6 Ω	$\frac{1}{8}$ W	Prec	1%
R304	322-0097-00		100 Ω	$\frac{1}{4}$ W	Prec	1%
R306	323-0054-00		35.7 Ω	$\frac{1}{2}$ W	Prec	1%
R313	321-0091-00		86.6 Ω	$\frac{1}{8}$ W	Prec	1%
R314	322-0097-00		100 Ω	$\frac{1}{4}$ W	Prec	1%
R321	323-0072-00		54.9 Ω	$\frac{1}{2}$ W	Prec	1%
R322	323-0060-00		41.2 Ω	$\frac{1}{2}$ W	Prec	1%
R323	322-0097-00		100 Ω	$\frac{1}{4}$ W	Prec	1%
R324	323-0181-00		750 Ω	$\frac{1}{2}$ W	Prec	1%
R325	322-0124-00		191 Ω	$\frac{1}{4}$ W	Prec	1%
R328	311-0480-00	B010100	500 Ω , Var			
R328	311-1224-00	B140000	500 Ω , Var			
R330	315-0390-00		39 Ω	$\frac{1}{4}$ W		5%
R331	315-0332-00		3.3 k Ω	$\frac{1}{4}$ W		5%
R332	323-0175-00		649 Ω	$\frac{1}{2}$ W	Prec	1%
R333	322-0097-00		100 Ω	$\frac{1}{4}$ W	Prec	1%
R334	323-0181-00		750 Ω	$\frac{1}{2}$ W	Prec	1%
R339	323-0116-00		158 Ω	$\frac{1}{2}$ W	Prec	1%
R340	321-0157-00		422 Ω	$\frac{1}{8}$ W	Prec	1%
R341	323-0079-00		64.9 Ω	$\frac{1}{2}$ W	Prec	1%
R342	321-0069-00		51.1 Ω	$\frac{1}{8}$ W	Prec	1%

A2 VERTICAL OUTPUT Circuit Board Assembly (cont)

Ckt. No.	Tektronix Part No.	Serial/Model No. Eff	Disc	Description		
Resistors (cont)						
R343	323-0138-00		267 Ω	1/2 W	Prec	1%
R344	301-0470-00		47 Ω	1/2 W		5%
R347	321-0117-00		162 Ω	1/8 W	Prec	1%
R348	307-0125-00		500 Ω	Thermal		
R353	323-0138-00		267 Ω	1/2 W	Prec	1%
R354	301-0470-00		47 Ω	1/2 W		5%

Transformer

T357	276-0517-00		Core, powder iron			
------	-------------	--	-------------------	--	--	--

A3 A SWEEP Circuit Board Assembly

*670-0417-02	B010100	B039999	Complete Board	
*670-0417-05	B040000		Complete Board	

Capacitors

Tolerance $\pm 20\%$ unless otherwise indicated.

C405	283-0080-00		0.022 μF	Cer	25 V	+80%—20%
C411	283-0092-00		0.03 μF	Cer	200 V	+80%—20%
C413	283-0065-00		0.001 μF	Cer	100 V	5%
C416	283-0080-00		0.022 μF	Cer	25 V	+80%—20%
C417	283-0080-00		0.022 μF	Cer	25 V	+80%—20%
C421	283-0031-00		0.1 μF	Cer	25 V	+80%—20%
C422	283-0080-00		0.022 μF	Cer	25 V	+80%—20%
C424	283-0080-00		0.022 μF	Cer	25 V	+80%—20%
C440	281-0543-00		270 pF	Cer	500 V	10%
C443	283-0080-00		0.022 μF	Cer	25 V	+80%—20%
C456	283-0080-00		0.022 μF	Cer	25 V	+80%—20%
C466	283-0080-00		0.022 μF	Cer	25 V	+80%—20%
C464	283-0080-00		0.022 μF	Cer	25 V	+80%—20%
C467	283-0081-00		0.1 μF	Cer	25 V	+80%—20%
C473	281-0519-00		47 pF	Cer	500 V	10%
C476	281-0602-00		68 pF	Cer	500 V	5%
C482	281-0523-00		100 pF	Cer	350 V	
C485	290-0246-00		3.3 μF	Elect.	15 V	10%
C493	283-0080-00		0.022 μF	Cer	25 V	+80%—20%
C497	283-0092-00		0.03 μF	Cer	200 V	+80%—20%
C498	290-0267-00		1 μF	Elect.	35 V	
C499	290-0267-00		1 μF	Elect.	35 V	
C503	281-0525-00		470 pF	Cer	500 V	
C506	281-0525-00		470 pF	Cer	500 V	
C509	281-0509-00		15 pF	Cer	500 V	10%

A3 A SWEEP Circuit Board Assembly (cont)

Kct. No.	Tektronix Part No.	Serial/Model No. Eff	No. Disc	Description		
Capacitors (cont)						
C511	283-0080-00		0.022 μ F	Cer	25 V	+80%—20%
C512	283-0080-00		0.022 μ F	Cer	25 V	+80%—20%
C517	281-0519-00		47 pF	Cer	500 V	10%
C523	281-0525-00		470 pF	Cer	500 V	
C526	281-0523-00		100 pF	Cer	350 V	
C534	283-0080-00		0.022 μ F	Cer	25 V	+80%—20%
C538	281-0558-00		18 pF	Cer	500 V	
C545	290-0135-00		15 μ F	Elect.	20 V	
C546	283-0078-00		0.001 μ F	Cer	500 V	
C547	281-0523-00		100 pF	Cer	350 V	
C561	283-0060-00		100 pF	Cer	200 V	5%
C566	281-0525-00		470 pF	Cer	500 V	
C568	283-0057-00		0.1 μ F	Cer	200 V	+80%—20%
C572	281-0519-00		47 pF	Cer	500 V	10%
C586	283-0080-00		0.022 μ F	Cer	25 V	+80%—20%
C597	283-0092-00		0.03 μ F	Cer	200 V	+80%—20%
C598	290-0135-00		15 μ F	Elect.	20 V	
C599	290-0135-00		15 μ F	Elect.	20 V	
C1251	290-0267-00		1 μ F	Elect.	35 V	
C1255	285-0595-00		0.1 μ F	PTM	100 V	1%
C1266	283-0010-00		0.05 μ F	Cer	50 V	
C1273	281-0519-00		47 pF	Cer	500 V	10%

Semiconductor Device, Diodes

CR408	152-0141-02	Silicon	1N4152
CR441	152-0246-00	Silicon	Low leakage 40 V, 0.25 W
CR449	*152-0185-00	Silicon	Replaceable by 1N4152
CR455	*152-0185-00	Silicon	Replaceable by 1N4152
CR456	*152-0185-00	Silicon	Replaceable by 1N4152
CR459	*152-0185-00	Silicon	Replaceable by 1N4152
CR465	*152-0185-00	Silicon	Replaceable by 1N4152
CR466	*152-0185-00	Silicon	Replaceable by 1N4152
CR474	*152-0153-00	Silicon	Replaceable by 1N4244
CR475	*152-0125-00	Tunnel	Selected TD 3A, 4.7 mA
CR483	*152-0185-00	Silicon	Replaceable by 1N4152
CR484	*152-0322-00	Silicon	Tek Spec
CR486	*152-0185-00	Silicon	Replaceable by 1N4152
CR493	*152-0185-00	Silicon	Replaceable by 1N4152
CR501	*152-0153-00	Silicon	Replaceable by 1N4244

A3 A SWEEP Circuit Board Assembly (cont)

Ckt. No.	Tektronix Part No.	Serial/Model No. Eff	Disc	Description
Semiconductor Device, Diodes (cont)				
CR505	*152-0125-00		Tunnel	Selected TD 3A, 4.7 mA
CR515	*152-0185-00		Silicon	Replaceable by 1N4152
CR517	*152-0185-00		Silicon	Replaceable by 1N4152
CR528	*152-0185-00		Silicon	Replaceable by 1N4152
CR529	*152-0185-00		Silicon	Replaceable by 1N4152
CR533	*152-0249-00		Silicon	Assembly
CR542	*152-0185-00		Silicon	Replaceable by 1N4152
CR543	*152-0185-00		Silicon	Replaceable by 1N4152
CR545	*152-0185-00		Silicon	Replaceable by 1N4152
CR546	*152-0185-00		Silicon	Replaceable by 1N4152
CR547	*152-0185-00		Silicon	Replaceable by 1N4152
CR566	*152-0185-00		Silicon	Replaceable by 1N4152
CR575	*152-0185-00		Silicon	Replaceable by 1N4152
CR583	*152-0185-00		Silicon	Replaceable by 1N4152
CR584	*152-0185-00		Silicon	Replaceable by 1N4152
CR591	*152-0185-00		Silicon	Replaceable by 1N4152
CR592	*152-0185-00		Silicon	Replaceable by 1N4152
CR593	*152-0185-00		Silicon	Replaceable by 1N4152
CR594	*152-0185-00		Silicon	Replaceable by 1N4152
CR595	*152-0185-00		Silicon	Replaceable by 1N4152
VR421	152-0166-00		Zener	1N753A 6.2V, 0.4 W, 5%
VR460	152-0278-00		Zener	1N437A 3 V, 0.4 W, 5%
VR544	152-0149-00		Zener	1N961B 10 V, 0.4 W, 5%
Bulb				
DS568	150-0035-00		Neon, A1D	
Inductors				
L469	*108-0181-01		0.2 μ H	
L484	*120-0382-00		Toroid, 14 turns single	
L498	276-0507-00		Core, ferramic suppressor	
L499	276-0507-00		Core, ferramic suppressor	
L536	276-0507-00		Core, ferramic suppressor	
L598	276-0507-00		Core, ferramic suppressor	
L599	276-0507-00		Core, ferramic suppressor	
LR459	*108-0487-00		0.27 μ H (wound on a 33 Ω resistor)	
Transistors				
Q404	151-0225-00		Silicon	NPN TO-18 2N3563
Q413	151-0223-00		Silicon	NPN TO-18 2N4275
Q414	151-0223-00		Silicon	NPN TO-18 2N4275
Q423	*151-0133-00		Silicon	PNP TO-18 Selected from 2N3251
Q443	151-1005-00		Silicon	FET N channel, junction type

A3 A SWEEP Circuit Board Assembly (cont)

Ckt. No.	Tektronix Part No.	Serial/Model No. Eff	Disc	Description		
Transistors (cont)						
Q453	151-0223-00		Silicon	NPN	TO-18	2N4275
Q454	151-0223-00		Silicon	NPN	TO-18	2N4275
Q464	151-0223-00		Silicon	NPN	TO-18	2N4275
Q473	151-0221-00		Silicon	PNP	TO-18	2N4258
Q484	151-0221-00		Silicon	PNP	TO-18	2N4258
Q485	151-0223-00		Silicon	NPN	TO-18	2N4275
Q494	151-0220-00		Silicon	PNP	TO-18	2N4122
Q495	151-0223-00		Silicon	NPN	TO-18	2N4275
Q504	151-0131-00		Germanium	PNP	TO-18	2N964
Q514	151-0223-00		Silicon	NPN	TO-18	2N4275
Q524	151-0223-00		Silicon	NPN	TO-18	2N4275
Q531	151-0223-00		Silicon	NPN	TO-18	2N4275
Q533	*153-0570-00		Silicon	FET		Selected
Q543	151-0220-00		Silicon	PNP	TO-18	2N4122
Q544	151-0220-00		Silicon	PNP	TO-18	2N4122
Q564	151-0220-00		Silicon	PNP	TO-18	2N4122
Q575	151-0220-00		Silicon	PNP	TO-18	2N4122
Q585	151-0220-00		Silicon	PNP	TO-18	2N4122
Q594	*151-0136-00		Silicon	NPN	TO-5	Replaceable by 2N3053
Q1255	151-0224-00		Silicon	NPN	TO-18	2N3692
Q1265	151-0224-00		Silicon	NPN	TO-18	2N3692
Q1274	151-0220-00		Silicon	PNP	TO-18	2N4122

Resistors

Resistors are fixed, composition, $\pm 10\%$ unless otherwise indicated.

R404	321-0097-00	100 Ω	$\frac{1}{8}$ W	Prec	1%
R405	316-0101-00	100 Ω	$\frac{1}{4}$ W		
R406	321-0227-00	2.26 k Ω	$\frac{1}{8}$ W	Prec	1%
R407	321-0064-00	45.3 Ω	$\frac{1}{8}$ W	Prec	1%
R408	321-0077-00	61.9 Ω	$\frac{1}{8}$ W	Prec	1%
R409	321-0212-00	1.58 k Ω	$\frac{1}{8}$ W	Prec	1%
R411	316-0471-00	470 Ω	$\frac{1}{4}$ W		
R412	308-0286-00	8.2 k Ω	3 W	WW	5%
R413	316-0101-00	100 Ω	$\frac{1}{4}$ W		
R416	316-0101-00	100 Ω	$\frac{1}{4}$ W		
R417	315-0471-00	470 Ω	$\frac{1}{4}$ W		5%
R419	321-0210-00	1.5 k Ω	$\frac{1}{8}$ W	Prec	1%
R421	315-0103-00	10 k Ω	$\frac{1}{4}$ W		5%
R422	316-0100-00	10 Ω	$\frac{1}{4}$ W		
R424	316-0221-00	220 Ω	$\frac{1}{4}$ W		

A3 A SWEEP Circuit Board Assembly (cont)

Ckt. No.	Tektronix Part No.	Serial/Model No. Eff	Disc	Description	
Resistors (cont)					
R427	315-0910-00			91 Ω	1/4 W 5%
R429	315-0910-00			91 Ω	1/4 W 5%
R438	315-0223-00			22 k Ω	1/4 W 5%
R439	301-0105-00			1 M Ω	1/2 W 5%
R440	301-0105-00			1 M Ω	1/2 W 5%
R441	316-0101-00			100 Ω	1/4 W
R443	315-0561-00			560 Ω	1/4 W 5%
R447	315-0113-00			11 k Ω	1/4 W 5%
R451	315-0392-00			3.9 k Ω	1/4 W 5%
R452	316-0270-00			27 Ω	1/4 W
R458	315-0112-00			1.1 k Ω	1/4 W 5%
R459	315-0560-00			56 Ω	1/4 W 5%
R461	315-0152-00			1.5 k Ω	1/4 W 5%
R462	311-0496-00	B010100	B139999	2.5 k Ω , Var	
R462	311-1226-00	B140000		2.5 k Ω , Var	5%
R463	315-0112-00			1.1 k Ω	1/4 W
R464	315-0561-00			560 Ω	1/4 W 5%
R465	316-0270-00			27 Ω	1/4 W
R466	315-0682-00			6.8 k Ω	1/4 W 5%
R467	315-0301-00			300 Ω	1/4 W 5%
R468	315-0510-00			51 Ω	1/4 W 5%
R469	315-0271-00			270 Ω	1/4 W 5%
R472	316-0470-00			47 Ω	1/4 W
R473	315-0243-00			24 k Ω	1/4 W 5%
R474	315-0220-00			22 Ω	1/4 W 5%
R476	315-0201-00			200 Ω	1/4 W 5%
R477	315-0392-00			3.9 k Ω	1/4 W 5%
R481	316-0101-00			100 Ω	1/4 W
R482	316-0270-00			27 Ω	1/4 W
R483	301-0183-00			18 k Ω	1/2 W 5%
R484	315-0153-00			15 k Ω	1/4 W 5%
R485	315-0152-00			1.5 k Ω	1/4 W 5%
R486	315-0104-00			100 k Ω	1/4 W 5%
R490	315-0271-00			270 Ω	1/4 W 5%
R492	315-0123-00			12 k Ω	1/4 W 5%
R493	316-0470-00			47 Ω	1/4 W 5%
R494	315-0104-00			100 k Ω	1/4 W 5%
R495	315-0102-00			1 k Ω	1/4 W 5%
R496	315-0222-00			2.2 k Ω	1/4 W 5%
R502	316-0101-00			100 Ω	1/4 W
R503	315-0201-00			200 Ω	1/4 W 5%

A3 A SWEEP Circuit Board Assembly (cont)

Ckt. No.	Tektronix Part No.	Serial/Model No. Eff	Disc	Description		
Resistors (cont)						
R506	315-0391-00		390 Ω	1/4 W		5%
R508	315-0202-00		2 kΩ	1/4 W		5%
R509	315-0821-00		820 Ω	1/4 W		5%
R510	315-0220-00	XB040000	22 Ω	1/4 W		5%
R511	315-0620-00		62 Ω	1/4 W		5%
R512	316-0470-00		47 Ω	1/4 W		
R513	321-0143-00		301 Ω	1/8 W	Prec	1%
R514	315-0122-00		1.2 kΩ	1/4 W		5%
R515	323-0301-00	13.3 kΩ	1/2 W	Prec	1%	
R517	315-0222-00	2.2 kΩ	1/4 W		5%	
R519	321-0277-00	7.5 kΩ	1/8 W	Prec	1%	
R521	321-0184-00	806 Ω	1/8 W	Prec	1%	
R522	321-0234-00	2.67 kΩ	1/8 W	Prec	1%	
R523	316-0470-00	47 Ω	1/4 W			
R524	315-0122-00	1.2 kΩ	1/4 W		5%	
R529	315-0331-00	330 Ω	1/4 W		5%	
R533	316-0101-00	100 Ω	1/4 W			
R534	316-0101-00	100 Ω	1/4 W			
R535	315-0123-00	12 kΩ	1/4 W		5%	
R536	316-0101-00	100 Ω	1/4 W			
R538	321-0259-00	4.87 kΩ	1/8 W	Prec	1%	
R539	308-0307-00	5 kΩ	3 W	WW	1%	
R540	315-0150-00	15 Ω	1/4 W		5%	
R543	316-0101-00	100 Ω	1/4 W			
R544	303-0822-00	8.2 kΩ	1 W		5%	
R546	316-0101-00	100 Ω	1/4 W			
R547	315-0331-00	330 Ω	1/4 W		5%	
R549	316-0101-00	100 Ω	1/4 W			
R561	321-0268-00	6.04 kΩ	1/8 W	Prec	1%	
R562	321-0182-00	768 Ω	1/8 W	Prec	1%	
R564	316-0473-00	47 kΩ	1/4 W			
R566	315-0223-00	22 kΩ	1/4 W		5%	
R567	316-0472-00	4.7 kΩ	1/4 W			
R568	316-0106-00	10 MΩ	1/4 W			
R574	321-0248-00	3.74 kΩ	1/8 W	Prec	1%	
R575	321-0188-00	887 Ω	1/8 W	Prec	1%	
R582	321-0200-00	1.18 kΩ	1/8 W	Prec	1%	
R583	321-0114-00	150 Ω	1/8 W	Prec	1%	
R585	321-0327-00	24.9 kΩ	1/8 W	Prec	1%	
R586	316-0470-00	47 Ω	1/4 W			
R587	321-0266-00	5.76 kΩ	1/8 W	Prec	1%	

A3 A SWEEP Circuit Board Assembly (cont)

Ckt. No.	Tektronix Part No.	Serial/Model No. Eff	Disc	Description		
Resistors (cont)						
R588	321-0268-00		6.04 k Ω	$\frac{1}{8}$ W	Prec	1%
R592	315-0512-00		5.1 k Ω	$\frac{1}{4}$ W		5%
R593	315-0512-00		5.1 k Ω	$\frac{1}{4}$ W		5%
R594	316-0473-00		47 k Ω	$\frac{1}{4}$ W		
R596	302-0820-00		82 Ω	$\frac{1}{2}$ W		
R1251	315-0120-00		12 Ω	$\frac{1}{4}$ W		5%
R1254	316-0471-00		470 Ω	$\frac{1}{4}$ W		
R1255	315-0472-00		4.7 k Ω	$\frac{1}{4}$ W		5%
R1264	316-0222-00		2.2 k Ω	$\frac{1}{4}$ W		5%
R1265	315-0882-00		6.8 k Ω	$\frac{1}{4}$ W		5%
R1266	316-0471-00		470 Ω	$\frac{1}{4}$ W		
R1274	321-0349-00		2.19 k Ω	$\frac{1}{8}$ W	Prec	$\frac{1}{4}$ %

Transformers

T474	*120-0361-00		Toroid, 9 turns bifilar
T1255	*120-0460-00		Calibrator frequency

A4 B SWEEP Circuit Board Assembly

*670-0418-05

Complete Board

CapacitorsTolerance $\pm 20\%$ unless otherwise indicated.

C629	281-0543-00		270 pF	Cer	500 V	10%
C633	283-0080-00		0.022 μ F	Cer	25 V	+80%—20%
C636	283-0080-00		0.022 μ F	Cer	25 V	+80%—20%
C639	283-0080-00		0.022 μ F	Cer	25 V	+80%—20%
C642	283-0080-00		0.022 μ F	Cer	25 V	+80%—20%
C656	283-0080-00		0.022 μ F	Cer	25 V	+80%—20%
C664	283-0080-00		0.022 μ F	Cer	25 V	+80%—20%
C666	283-0080-00		0.022 μ F	Cer	25 V	+80%—20%
C667	283-0081-00		0.1 μ F	Cer	25 V	+80%—20%
C673	281-0519-00		47 pF	Cer	500 V	10%
C676	281-0540-00		51 pF	Cer	500 V	5%
C688	281-0602-00		68 pF	Cer	500 V	5%
C698	290-0267-00		1 μ F	Elect.	35 V	
C699	290-0267-00		1 μ F	Elect.	35 V	
C702	281-0580-00		470 pF	Cer	500 V	10%

A4 B SWEEP Circuit Board Assembly (cont)

Ckt. No.	Tektronix Part No.	Serial/Model No. Eff	Disc	Description		
Capacitors (cont)						
C704	281-0509-00			15 pF	Cer	500 V 10%
C705	281-0580-00			470 pF	Cer	500 V 10%
C715	283-0080-00			0.022 μ F	Cer	25 V +80%—20%
C722	281-0580-00			470 pF	Cer	500 V 10%
C731	283-0060-00			100 pF	Cer	200 V 5%
C732	283-0080-00			0.022 μ F	Cer	25 V +80%—20%
C741	283-0092-00			0.03 μ F	Cer	200 V +80%—20%
C744	283-0080-00			0.022 μ F	Cer	25 V +80%—20%
C748	281-0542-00			18 pF	Cer	500 V 10%
C755	281-0605-00			200 pF	Cer	500 V
C756	281-0523-00			100 pF	Cer	350 V
C759	290-0248-01	B010100	B099999	150 μ F	Elect.	15 V
C759	290-0296-00	B100000		100 μ F	Elect.	20 V
C768	281-0504-00			10 pF	Cer	500 V 10%
C774	281-0549-00			68 pF	Cer	500 V 10%
C780	281-0622-00			47 pF	Cer	500 V 1%
C785	281-0519-00			47 pF	Cer	500 V 10%
C786	283-0080-00			0.022 μ F	Cer	25 V +80%—20%
C796	283-0081-00			0.1 μ F	Cer	25 V +80%—20%
C797	283-0092-00			0.03 μ F	Cer	200 V
C798	290-0135-00			15 μ F	Elect.	20 V
C799	290-0135-00			15 μ F	Elect.	20 V
C804	283-0059-00			1 μ F	Cer	25 V +80%—20%
C806	283-0080-00			0.022 μ F	Cer	25 V +80%—20%
C807	283-0080-00			0.022 μ F	Cer	25 V +80%—20%
C882	281-0064-00			0.25-1.5 pF, Var	Tub.	
C892	281-0064-00			0.25-1.5 pF, Var	Tub.	
C898	290-0267-00			1 μ F	Elect.	35 V
C899	290-0267-00			1 μ F	Elect.	35 V

Semiconductor Device, Diodes

CR631	152-0246-00			Silicon		Low leakage 40 V, 0.25 W
CR635	*152-0185-00			Silicon		Replaceable by 1N4152
CR638	*152-0185-00			Silicon		Replaceable by 1N4152
CR641	*152-0185-00			Silicon		Replaceable by 1N4152
CR651	*152-0185-00			Silicon		Replaceable by 1N4152
CR653	*152-0185-00			Silicon		Replaceable by 1N4152
CR655	*152-0185-00			Silicon		Replaceable by 1N4152
CR656	*152-0185-00			Silicon		Replaceable by 1N4152
CR665	*152-0185-00			Silicon		Replaceable by 1N4152
CR666	*152-0185-00			Silicon		Replaceable by 1N4152

A4 B SWEEP Circuit Board Assembly (cont)

Ckt. No.	Tektronix Part No.	Serial/Model No. Eff	Disc	Description
Semiconductor Device, Diodes (cont)				
CR675	*152-0125-00		Tunnel	Selected TD 3A, 4.7 mA
CR678	*152-0153-00		Silicon	Replaceable by 1N4244
CR701	*152-0153-00		Silicon	Replaceable by 1N4244
CR705	*152-0125-00		Tunnel	Selected TD 3A, 4.7 mA
CR714	*152-0185-00		Silicon	Replaceable by 1N4152
CR727	*152-0185-00		Silicon	Replaceable by 1N4152
CR728	*152-0185-00		Silicon	Replaceable by 1N4152
CR731	*152-0185-00		Silicon	Replaceable by 1N4152
CR742	*152-0249-00		Silicon	Assembly
CR748	*152-0185-00		Silicon	Replaceable by 1N4152
CR752	*152-0185-00		Silicon	Replaceable by 1N4152
CR753	*152-0185-00		Silicon	Replaceable by 1N4152
CR754	*152-0185-00		Silicon	Replaceable by 1N4152
CR755	*152-0185-00		Silicon	Replaceable by 1N4152
CR756	*152-0185-00		Silicon	Replaceable by 1N4152
CR764A,B	*152-0151-00		Silicon, assembly	matched pair of 1N4152
CR776	*152-0185-00		Silicon	Replaceable by 1N4152
CR777	*152-0185-00		Silicon	Replaceable by 1N4152
CR795	*152-0185-00		Silicon	Replaceable by 1N4152
CR796	*152-0185-00		Silicon	Replaceable by 1N4152
CR797	*152-0185-00		Silicon	Replaceable by 1N4152
CR798	*152-0185-00		Silicon	Replaceable by 1N4152
CR851	*152-0153-00		Silicon	Replaceable by 1N4244
CR852	*152-0153-00		Silicon	Replaceable by 1N4244
CR861	152-0141-02		Silicon	1N4152
CR871	152-0141-02		Silicon	1N4152
VR654	152-0278-00		Zener	1N4372A, 3 V, 0.4 W, 5%

Inductors

L672	*108-0181-01		0.2 μ H
L698	276-0507-00		Core, ferramic suppressor
L699	276-0507-00		Core, ferramic suppressor
L746	276-0507-00		Core, ferramic suppressor
L798	276-0507-00		Core, ferramic suppressor
L799	276-0507-00		Core, ferramic suppressor
L898	276-0507-00		Core, ferramic suppressor
L899	276-0507-00		Core, ferramic suppressor
LR653	*108-0487-00		0.27 μ H (wound on a 33 Ω resistor)

A4 B SWEEP Circuit Board Assembly (cont)

Ckt. No.	Tektronix Part No.	Serial/Model No. Eff	No. Disc	Description	
Transistors					
Q633	151-1005-00			Silicon	FET N channel, junction type
Q643	151-0223-00			Silicon	NPN TO-18 2N4275
Q654	151-0223-00			Silicon	NPN TO-18 2N4275
Q664	151-0223-00			Silicon	NPN TO-18 2N4275
Q684	151-0221-00			Silicon	PNP TO-18 2N4258
Q704	151-0131-00			Germanium	PNP TO-18 2N964
Q714	151-0223-00			Silicon	NPN TO-18 2N4275
Q724	151-0223-00			Silicon	NPN TO-18 2N4275
Q734	151-0223-00			Silicon	NPN TO-18 2N4275
Q741	151-0223-00			Silicon	NPN TO-18 2N4275
Q743	*153-0570-00			Silicon	FET Selected
Q753	151-0220-00			Silicon	PNP TO-18 2N4122
Q754	151-0220-00			Silicon	PNP TO-18 2N4122
Q764A,B	*151-0104-00			Silicon	NPN TO-5 Replaceable by 2N2913
Q768	151-0220-00			Silicon	PNP TO-18 2N4122
Q769	151-0224-00			Silicon	NPN TO-18 2N3692
Q772	151-0220-00			Silicon	PNP TO-18 2N4122
Q775	151-0220-00			Silicon	PNP TO-18 2N4122
Q779	151-0220-00			Silicon	PNP TO-18 2N4122
Q785	151-0220-00			Silicon	PNP TO-18 2N4122
Q790	151-0220-00			Silicon	PNP TO-18 2N4122
Q797	151-0223-00			Silicon	NPN TO-18 2N4275
Q814	151-0223-00			Silicon	NPN TO-18 2N4275
Q824	151-0223-00			Silicon	NPN TO-18 2N4275
Q834	151-0220-00			Silicon	PNP TO-18 2N4122
Q844	151-0220-00			Silicon	PNP TO-18 2N4122
Q863	151-0220-00			Silicon	PNP TO-18 2N4122
Q873	151-0220-00			Silicon	PNP TO-18 2N4122

Resistors

Resistors are fixed, composition, $\pm 10\%$ unless otherwise indicated.

R531	311-0462-00	B010100	B139999	1 k Ω , Var		
R531	311-1225-00	B140000		1 k Ω , Var		
R627	315-0223-00			22 k Ω	1/4 W	5%
R628	301-0105-00			1 M Ω	1/2 W	5%
R629	301-0105-00			1 M Ω	1/2 W	5%
R631	316-0101-00			100 Ω	1/4 W	
R633	315-0561-00			560 Ω	1/4 W	5%
R634	315-0113-00			11 k Ω	1/4 W	5%
R635	316-0183-00			18 k Ω	1/4 W	
R636	316-0332-00			3.3 k Ω	1/4 W	
R638	315-0183-00			18 k Ω	1/4 W	5%

A4 B SWEEP Circuit Board Assembly (cont)

Ckt. No.	Tektronix Part No.	Serial/Model No. Eff	Disc	Description		
Resistors (cont)						
R639	316-0332-00			3.3 k Ω	1/4 W	
R641	315-0183-00			18 k Ω	1/4 W	5%
R642	316-0332-00			3.3 k Ω	1/4 W	
R644	321-0289-00			10 k Ω	1/8 W	Prec
R645	311-0463-00	B010100	B139999	5 k Ω , Var		1%
R645	311-1227-00	B140000		5 k Ω , Var		
R646	315-0824-00			820 k Ω	1/4 W	5%
R650	316-0270-00			27 Ω	1/4 W	
R653	315-0112-00			1.1 k Ω	1/4 W	5%
R659	315-0560-00			56 Ω	1/4 W	5%
R661	315-0152-00			1.5 k Ω	1/4 W	5%
R662	311-0496-00	B010100	B139999	2.5 k Ω , Var		
R662	311-1226-00	B140000		2.5 k Ω , Var		
R663	315-0112-00			1.1 k Ω	1/4 W	5%
R664	315-0621-00			620 Ω	1/4 W	5%
R665	316-0270-00			27 Ω	1/4 W	
R666	315-0332-00			3.3 k Ω	1/4 W	5%
R667	315-0301-00			300 Ω	1/4 W	5%
R671	315-0510-00			51 Ω	1/4 W	5%
R672	315-0271-00			270 Ω	1/4 W	5%
R674	315-0243-00			24 k Ω	1/4 W	5%
R676	315-0270-00			27 Ω	1/4 W	5%
R677	316-0470-00			47 Ω	1/4 W	
R686	315-0220-00			22 Ω	1/4 W	5%
R688	315-0201-00			200 Ω	1/4 W	5%
R689	315-0392-00			3.9 k Ω	1/4 W	5%
R702	315-0201-00			200 Ω	1/4 W	5%
R704	315-0821-00			820 Ω	1/4 W	5%
R705	315-0391-00			390 Ω	1/4 W	5%
R708	315-0202-00			2 k Ω	1/4 W	5%
R710	315-0220-00			22 Ω	1/4 W	5%
R713	321-0184-00			806 Ω	1/8 W	Prec
R714	315-0122-00			1.2 k Ω	1/4 W	5%
R715	315-0620-00			62 Ω	1/4 W	5%
R717	321-0260-00			4.99 k Ω	1/8 W	Prec
R718	315-0333-00			33 k Ω	1/4 W	5%
R719	315-0823-00			82 k Ω	1/4 W	5%
R721	321-0184-00			806 Ω	1/8 W	Prec
R722	321-0234-00			2.67 k Ω	1/8 W	Prec
R723	316-0470-00			47 Ω	1/4 W	
R724	315-0122-00			1.2 k Ω	1/4 W	5%

A4 B SWEEP Circuit Board Assembly (cont)

Ckt. No.	Tektronix Part No.	Serial/Model No. Eff	Disc	Description		
Resistors (cont)						
R728	315-0331-00			330 Ω	1/4 W	5%
R731	315-0153-00			15 k Ω	1/4 W	5%
R733	315-0471-00			470 Ω	1/4 W	5%
R734	316-0103-00			10 k Ω	1/4 W	
R735	316-0104-00			100 k Ω	1/4 W	
R741	311-0462-00	B010100	B139999	1 k Ω , Var		
R741	311-1225-00	B140000		1 k Ω , Var		
R743	316-0101-00			100 Ω	1/4 W	
R744	316-0101-00			100 Ω	1/4 W	
R745	315-0123-00			12 k Ω	1/4 W	5%
R746	316-0101-00			100 Ω	1/4 W	
R748	321-0259-00			4.87 k Ω	1/8 W	Prec 1%
R749	308-0307-00			5 k Ω	3 W	WW 1%
R750	316-0101-00			100 Ω	1/4 W	
R751	315-0150-00			15 Ω	1/4 W	5%
R753	316-0101-00			100 Ω	1/4 W	
R754	304-0103-00			10 k Ω	1 W	
R755	316-0221-00			220 Ω	1/4 W	
R756	315-0331-00			330 Ω	1/4 W	5%
R757	323-0299-00			12.7 k Ω	1/2 W	Prec 1%
R758	311-0514-00			100 Ω , Var		
R759	321-0126-00			200 Ω	1/8 W	Prec 1%
R761	316-0101-00			100 Ω	1/4 W	
R763	321-0155-00			402 Ω	1/8 W	Prec 1%
R765	301-0822-00			8.2 k Ω	1/2 W	5%
R766	315-0122-00			1.2 k Ω	1/4 W	5%
R767	315-0351-00			360 Ω	1/4 W	5%
R768	315-0682-00			6.8 k Ω	1/4 W	5%
R769	321-0245-00			3.48 k Ω	1/8 W	Prec 1%
R770	301-0622-00			6.2 k Ω	1/2 W	5%
R771	315-0122-00			1.2 k Ω	1/4 W	5%
R772	315-0102-00			1 k Ω	1/4 W	5%
R773	301-0822-00			8.2 k Ω	1/2 W	5%
R775	321-0207-00			1.4 k Ω	1/8 W	Prec 1%
R776	321-0305-00			14.7 k Ω	1/8 W	Prec 1%
R777	321-0198-00			1.13 k Ω	1/8 W	Prec 1%
R778	321-0333-00			28.7 k Ω	1/8 W	Prec 1%
R779	321-0179-00			715 Ω	1/8 W	Prec 1%
R780	321-0227-00			2.26 k Ω	1/8 W	Prec 1%
R781	321-0231-00			2.49 k Ω	1/8 W	Prec 1%
R782	321-0179-00			715 Ω	1/8 W	Prec 1%

A4 B SWEEP Circuit Board Assembly (cont)

Ckt. No.	Tektronix Part No.	Serial/Model No. Eff	Disc	Description		
Resistors (cont)						
R783	321-0198-00			1.13 k Ω	1/8 W	Prec 1%
R784	321-0231-00			2.49 k Ω	1/8 W	Prec 1%
R785	321-0227-00			2.26 k Ω	1/8 W	Prec 1%
R786	315-0392-00			3.9 k Ω	1/4 W	5%
R787	321-0248-00			3.74 k Ω	1/8 W	Prec 1%
R789	316-0101-00			100 Ω	1/4 W	
R790	321-0148-00			340 Ω	1/8 W	Prec 1%
R791	315-0103-00			10 k Ω	1/4 W	5%
R792	315-0103-00			10 k Ω	1/4 W	5%
R794	315-0203-00			20 k Ω	1/4 W	5%
R796	315-0100-00			10 k Ω	1/4 W	5%
R797	315-0302-00			3 k Ω	1/4 W	5%
R798	315-0302-00			3 k Ω	1/4 W	5%
R803	315-0510-00			51 Ω	1/4 W	5%
R804	315-0822-00			8.2 k Ω	1/4 W	5%
R806	315-0184-00			180 k Ω	1/4 W	5%
R807	315-0822-00			8.2 k Ω	1/4 W	5%
R809	321-0231-00			2.49 k Ω	1/8 W	Prec 1%
R812	321-0260-00			4.99 k Ω	1/8 W	Prec 1%
R814	304-0103-00			10 k Ω	1 W	
R821	315-0510-00			51 Ω	1/4 W	5%
R822	321-0263-00			5.36 k Ω	1/8 W	Prec 1%
R824	304-0103-00			10 k Ω	1 W	
R826	321-0231-00			2.49 k Ω	1/8 W	Prec 1%
R828	315-0272-00			2.7 k Ω	1/4 W	5%
R831	315-0153-00			15 k Ω	1/4 W	5%
R833	323-0305-00			14.7 k Ω	1/2 W	Prec 1%
R834	322-0216-00			1.74 k Ω	1/4 W	Prec 1%
R835	311-0480-00	B010100	B139999	500 Ω , Var		
R835	311-1224-00	B140000		500 Ω , Var		
R836	321-0213-00			1.62 k Ω	1/8 W	Prec 1%
R841	315-0153-00			15 k Ω	1/4 W	5%
R843	323-0305-00			14.7 k Ω	1/2 W	Prec 1%
R844	322-0216-00			1.74 k Ω	1/4 W	Prec 1%
R845	311-0433-00	B010100	B139999	100 Ω , Var		
R845	311-1222-00	B140000		100 Ω , Var		
R846	321-0110-00			137 Ω	1/8 W	Prec 1%
R854	315-0103-00			10 k Ω	1/4 W	5%
R855	311-0541-00	B010100	B139999	20 k Ω , Var		
R855	311-1230-00	B140000		20 k Ω , Var		
R856	315-0103-00			10 k Ω	1/4 W	5%
R862	315-0273-00			27 k Ω	1/4 W	5%
R863	316-0122-00			1.2 k Ω	1/4 W	

A4 B SWEEP Circuit Board Assembly (cont)

Ckt. No.	Tektronix Part No.	Serial/Model No. Eff	Disc	Description
Resistors (cont)				
R864	315-0681-00		680 Ω	1/4 W 5%
R872	315-0273-00		27 kΩ	1/4 W 5%
R873	316-0122-00		1.2 kΩ	1/4 W
R874	315-0681-00		680 Ω	1/4 W 5%
R882	323-0322-00		22.1 kΩ	1/2 W Prec 1%
R892	323-0322-00		22.1 kΩ	1/2 W Prec 1%

Transformer

T686	*120-0361-00			Toroid, 9 turns bifilar
------	--------------	--	--	-------------------------

A5 Z AXIS Circuit Board Assembly

*670-0414-07	B010100	B079999	Complete Board
*670-0414-06	B080000		Complete Board

Capacitors

Tolerance ±20% unless otherwise indicated.

C902	285-0633-00	B010100	B079999	0.22 μF	PTM	100 V	10%
C902	285-0919-00	B080000		0.22 μF	PTM	100 V	10%
C913	285-0622-00			0.1 μF	PTM	100 V	
C982	283-0003-00			0.01 μF	Cer	150 V	
C1007	283-0080-00			0.022 μF	Cer	25 V	+80%—20%
C1015	283-0080-00			0.022 μF	Cer	25 V	+80%—20%
C1016	283-0003-00			0.01 μF	Cer	150 V	
C1022	281-0547-00			2.7 pF	Cer	500 V	10%
C1023	283-0080-00			0.022 μF	Cer	25 V	+80%—20%
C1026	283-0080-00			0.022 μF	Cer	25 V	+80%—20%
C1029	283-0083-00			0.0047 μF	Cer	500 V	5%
C1034	283-0092-00			0.03 μF	Cer	200 V	+80%—20%
C1036	281-0064-00			0.25-1.5 pF, Var	Tub.		
C1037	281-0547-00			2.7 pF	Cer	500 V	10%
C1041	283-0092-00			0.03 μF	Cer	200 V	+80%—20%
C1043	283-0092-00			0.03 μF	Cer	200 V	+80%—20%
C1044	283-0092-00			0.03 μF	Cer	200 V	+80%—20%
C1048	283-0080-00			0.022 μF	Cer	25 V	+80%—20%

Semiconductor Device, Diodes

CR1015	*152-0153-00		Silicon	Replaceable by 1N4244
CR1016	*152-0153-00		Silicon	Replaceable by 1N4244
CR1042	*152-0061-00		Silicon	Tek Spec
CR1044	*152-0061-00		Silicon	Tek Spec
CR1045	*152-0185-00		Silicon	Replaceable by 1N4152
VR1043	152-0024-00		Zener	1N3024B 15 V, 1 W, 5%

A5 Z AXIS Circuit Board Assembly (cont)

Ckt. No.	Tektronix Part No.	Serial/Model No. Eff	Disc	Description		
Transistors						
Q913	151-0220-00			Silicon	PNP	TO-18 2N4122
Q914	*151-0126-00			Silicon	NPN	TO-18 Replaceable by 2N2484
Q923	*151-0136-00			Silicon	NPN	TO-5 Replaceable by 2N3053
Q1014	151-0223-00			Silicon	NPN	TO-18 2N4275
Q1023	*151-0190-01			Silicon	NPN	TO-106 Tek Spec
Q1024	151-0214-00	B010100	B139999	Silicon	PNP	TO-5 2N3495
Q1024	151-0270-00	B140000		Silicon	PNP	TO-5 Selected from 2N3495
Q1034	*151-0124-00			Silicon	NPN	TO-5 Selected from 2N3119
Q1043	*151-0124-00			Silicon	NPN	TO-5 Selected from 2N3119
Resistors						
Resistors are fixed, composition, $\pm 10\%$ unless otherwise indicated.						
R900	311-0465-00	B010100	B139999	100 k Ω , Var		
R900	311-1235-00	B140000		100 k Ω , Var		
R901	301-0435-00			4.3 M Ω	1/2 W	5%
R912	316-0103-00			10 k Ω	1/4 W	
R913	316-0102-00			1 k Ω	1/4 W	
R915	316-0474-00			470 k Ω	1/4 W	
R916	316-0101-00			100 Ω	1/4 W	
R917	316-0104-00			100 k Ω	1/4 W	
R925	301-0303-00			30 k Ω	1/2 W	5%
R982	311-0465-00	B010100	B139999	100 k Ω , Var		
R982	311-1235-00	B140000		100 k Ω , Var		
R1004	316-0470-00			47 Ω	1/4 W	
R1006	315-0123-00			12 k Ω	1/4 W	5%
R1007	315-0123-00			12 k Ω	1/4 W	5%
R1008	321-0241-00			3.16 k Ω	1/8 W	Prec 1%
R1011	301-0473-00			47 k Ω	1/2 W	5%
R1012	316-0470-00			47 Ω	1/4 W	
R1013	321-0241-00			3.16 k Ω	1/8 W	Prec 1%
R1014	316-0471-00			470 Ω	1/4 W	
R1015	316-0101-00			100 Ω	1/4 W	
R1016	323-0318-00			20 k Ω	1/2 W	Prec 1%
R1021	315-0390-00			39 Ω	1/4 W	5%
R1023	315-0221-00			220 Ω	1/4 W	5%
R1024	315-0121-00			120 Ω	1/4 W	5%
R1025	301-0751-00			750 Ω	1/2 W	5%
R1026	316-0470-00			47 Ω	1/4 W	
R1029	316-0102-00			1 k Ω	1/4 W	
R1033	315-0240-00			24 Ω	1/4 W	5%
R1034	301-0243-00			24 k Ω	1/2 W	5%
R1036	323-0335-00			30.1 k Ω	1/2 W	Prec 1%
R1041	316-0101-00			100 Ω	1/4 W	
R1042	305-0183-00			18 k Ω	2 W	5%

A5 Z AXIS Circuit Board Assembly (cont)

Ckt. No.	Tektronix Part No.	Serial/Model No. Eff	No. Disc	Description		
Resistors (cont)						
R1043	308-0348-00			3.32 k Ω	3 W	WW 1%
R1044	316-0101-00			100 Ω	1/4 W	
R1046	301-0680-00			68 Ω	1/2 W	5%
R1047	305-0822-00			8.2 k Ω	2 W	5%
R1048	316-0101-00			100 Ω	1/4 W	

A6 LOW VOLTAGE REGULATOR Circuit Board Assembly

*670-0415-00

Complete Board

Capacitors

Tolerance $\pm 20\%$ unless otherwise indicated.

C1114	290-0171-00			100 μ F	Elect.	12 V	
C1121	290-0162-00			22 μ F	Elect.	35 V	
C1128	283-0078-00			0.001 μ F	Cer	500 V	
C1151	290-0162-00			22 μ F	Elect.	35 V	
C1156	283-0078-00			0.001 μ F	Cer	500 V	
C1164	290-0286-00	B010100	B099999	50 μ F	Elect.	25 V	+75%—10%
C1164	290-0209-00	B100000		50 μ F	Elect.	25 V	+75%—10%
C1181	290-0198-00	B010100	B099999	17 μ F	Elect.	150 V	+30%—15%
C1181	290-0226-00	B100000		20 μ F	Elect.	100 V	
C1184	283-0079-00			0.01 μ F	Cer	250 V	
C1185	285-0622-00			0.1 μ F	PTM	100 V	
C1194	290-0305-00	B010100	B099999	3 μ F	Elect.	150 V	
C1194	290-0159-00	B100000		2 μ F	Elect.	150 V	

Semiconductor Device, Diodes

CR1152	*152-0185-00			Silicon		Replaceable by 1N4152
CR1164	*152-0185-00			Silicon		Replaceable by 1N4152
CR1182	*152-0185-00			Silicon		Replaceable by 1N4152
CR1188	*152-0185-00			Silicon		Replaceable by 1N4152
CR1189	*152-0185-00			Silicon		Replaceable by 1N4152
CR1194	*152-0185-00			Silicon		Replaceable by 1N4152
CR1198	152-0066-00			Silicon		1N3194
VR1114	152-0212-00			Zener		1N936 9 V, 5% TC
VR1185	152-0150-00			Zener		1N3037B 51 V, 1 W, 5%
VR1209	152-0293-00			Zener		1N3032B 33 V, 1 W, 5%

Transistors

Q1114	151-0224-00			Silicon	NPN	TO-18 2N3692
Q1124	151-0224-00			Silicon	NPN	TO-18 2N3692
Q1129	151-0224-00			Silicon	NPN	TO-18 2N3692
Q1154	151-0224-00			Silicon	NPN	TO-18 2N3692
Q1159	151-0224-00			Silicon	NPN	TO-18 2N3692

A6 LOW VOLTAGE REGULATOR Circuit Board Assembly (cont)

Ckt. No.	Tektronix Part No.	Serial/Model No. Eff	Disc	Description
Transistors (cont)				
Q1184	151-0224-00		Silicon	NPN TO-18 2N3692
Q1189	151-0250-00		Silicon	NPN TO-104 2N5184
Q1193	*151-0136-00		Silicon	NPN TO-5 Replaceable by 2N3053

ResistorsResistors are fixed, composition, $\pm 10\%$ unless otherwise indicated.

R1114	323-0154-00	392 Ω	$\frac{1}{2}$ W	Prec	1%
R1117	301-0273-00	27 k Ω	$\frac{1}{2}$ W		5%
R1119	315-0561-00	560 Ω	$\frac{1}{4}$ W		5%
R1121	323-0212-00	1.58 k Ω	$\frac{1}{2}$ W	Prec	1%
R1122	311-0515-00	250 Ω , Var			
R1123	323-0160-00	453 Ω	$\frac{1}{2}$ W	Prec	1%
R1129	308-0224-00	0.3 Ω	2 W	WW	
R1133	316-0121-00	120 Ω	$\frac{1}{4}$ W		
R1151	323-0210-00	1.5 k Ω	$\frac{1}{2}$ W	Prec	1%
R1152	311-0514-00	100 Ω , Var			
R1153	323-0205-00	1.33 k Ω	$\frac{1}{2}$ W	Prec	1%
R1154	323-0373-00	75 k Ω	$\frac{1}{2}$ W	Prec	1%
R1156	301-0243-00	24 k Ω	$\frac{1}{2}$ W		5%
R1159	308-0244-00	0.3 Ω	2 W	WW	
R1163	316-0121-00	120 Ω	$\frac{1}{4}$ W		
R1164	316-0123-00	12 k Ω	$\frac{1}{4}$ W		
R1181	323-0308-00	15.8 k Ω	$\frac{1}{2}$ W	Prec	1%
R1182	311-0515-00	250 Ω , Var			
R1183	323-0222-00	2 k Ω	$\frac{1}{2}$ W	Prec	1%
R1184	323-0373-00	75 k Ω	$\frac{1}{2}$ W	Prec	1%
R1185	316-0103-00	10 k Ω	$\frac{1}{4}$ W		
R1186	315-0333-00	33 k Ω	$\frac{1}{4}$ W		5%
R1187	307-0093-00	1.2 Ω	$\frac{1}{2}$ W		5%
R1188	316-0470-00	47 Ω	$\frac{1}{4}$ W		
R1189	315-0683-00	68 k Ω	$\frac{1}{4}$ W		5%
R1193	316-0121-00	120 Ω	$\frac{1}{4}$ W		
R1194	316-0823-00	82 k Ω	$\frac{1}{4}$ W		
R1209	301-0123-00	12 k Ω	$\frac{1}{2}$ W		5%

SECTION 8

DIAGRAMS AND CIRCUIT BOARD ILLUSTRATIONS

Symbols and Reference Designators

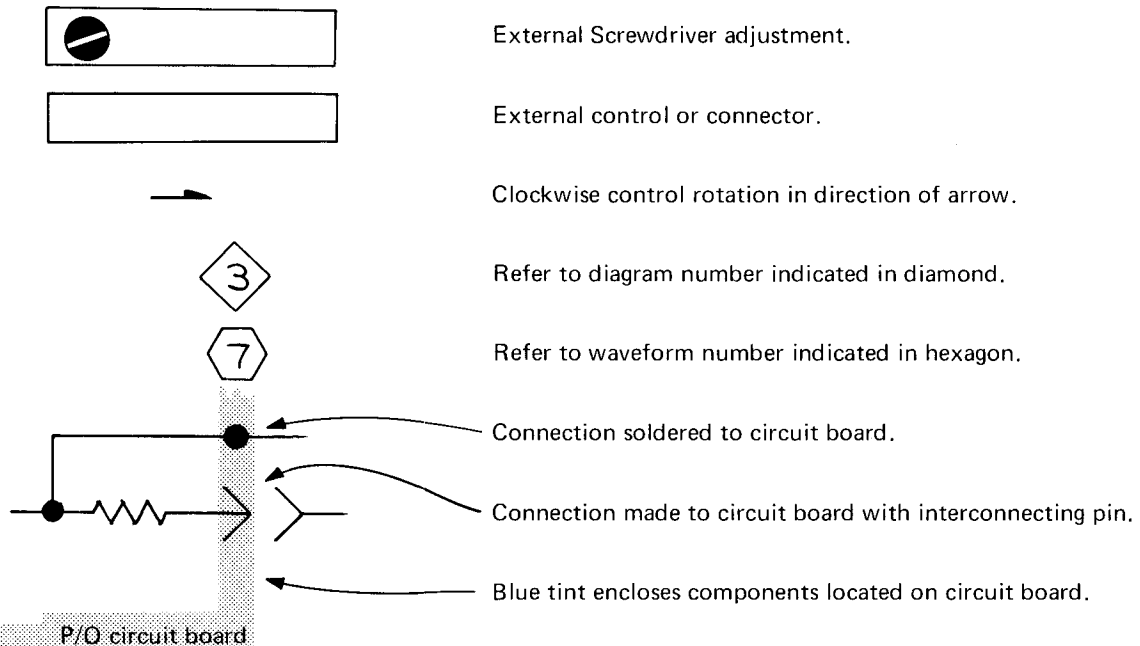
Electrical components shown on the diagrams are in the following units unless noted otherwise:

Capacitors = Values one or greater are in picofarads (pF).
 Values less than one are in microfarads (μ F).
 Resistors = Ohms (Ω)

Symbols used on the diagrams are based on USA Standard Y32.2-1967.

Logic symbology is based on MIL-STD-806B in terms of positive logic. Logic symbols depict the logic function performed and may differ from the manufacturer's data.

The following special symbols are used on the diagrams:



The following prefix letters are used as reference designators to identify components or assemblies on the diagrams.

A	Assembly, separable or repairable (circuit board, etc.)	LR	Inductor/resistor combination
AT	Attenuator, fixed or variable	M	Meter
B	Motor	Q	Transistor or silicon-controlled rectifier
BT	Battery	P	Connector, movable portion
C	Capacitor, fixed or variable	R	Resistor, fixed or variable
CR	Diode, signal or rectifier	RT	Thermistor
DL	Delay line	S	Switch
DS	Indicating device (lamp)	T	Transformer
F	Fuse	TP	Test point
FL	Filter	U	Assembly, inseparable or non-repairable (integrated circuit, etc.)
H	Heat dissipating device (heat sink, heat radiator, etc.)	V	Electron tube
HR	Heater	VR	Voltage regulator (zener diode, etc.)
J	Connector, stationary portion	Y	Crystal
K	Relay		
L	Inductor, fixed or variable		

VOLTAGE AND WAVEFORM TEST CONDITIONS

Typical voltage measurements and waveform photographs were obtained under the following conditions unless noted otherwise on the individual diagrams:

Test Oscilloscope (with 10X Probe)

Frequency response	DC to 20 megahertz
Deflection factor (with probe)	50 millivolts to 10 volts/ division
Input impedance	10 megohm, 13 picofarads
Probe ground	453A chassis ground
Trigger source	External from A GATE connector to indicate true time relationship between signals
Recommended type (as used for waveforms on diagrams)	Tektronix 7504 with 7A16 and 7B50 plug-in units

Voltmeter

Type	Non-loading digital voltmeter
Input impedance	10 megohm
Range	0 to 1000 volts
Reference voltage	453A chassis ground
Recommended type (as used for voltages on diagrams)	Tektronix 7D13 Digital Multimeter (used with test oscilloscope)

453A Conditions

Line voltage	115 volts
Signal applied	No signal applied for voltage measurements. Apply calibrator signal to Channel 1 for waveforms only.
Connectors	No connections except as in Signal applied above.
Trace position	Centered on CRT
Control settings	As follows except as noted otherwise on individual diagrams.

Display Controls

INTENSITY	Midrange
FOCUS	Adjust for focused display
SCALE ILLUM	As desired

Vertical Controls (both channels if applicable)

VOLTS/DIV	20 mV
VAR	Calibrated
POSITION	Midrange
Input Coupling	DC
MODE	CH 1
INT TRIG	NORM
INVERT	Pushed in

Triggering Controls (both A and B if applicable)

LEVEL	0
SLOPE	+
COUPLING	AC
SOURCE	INT

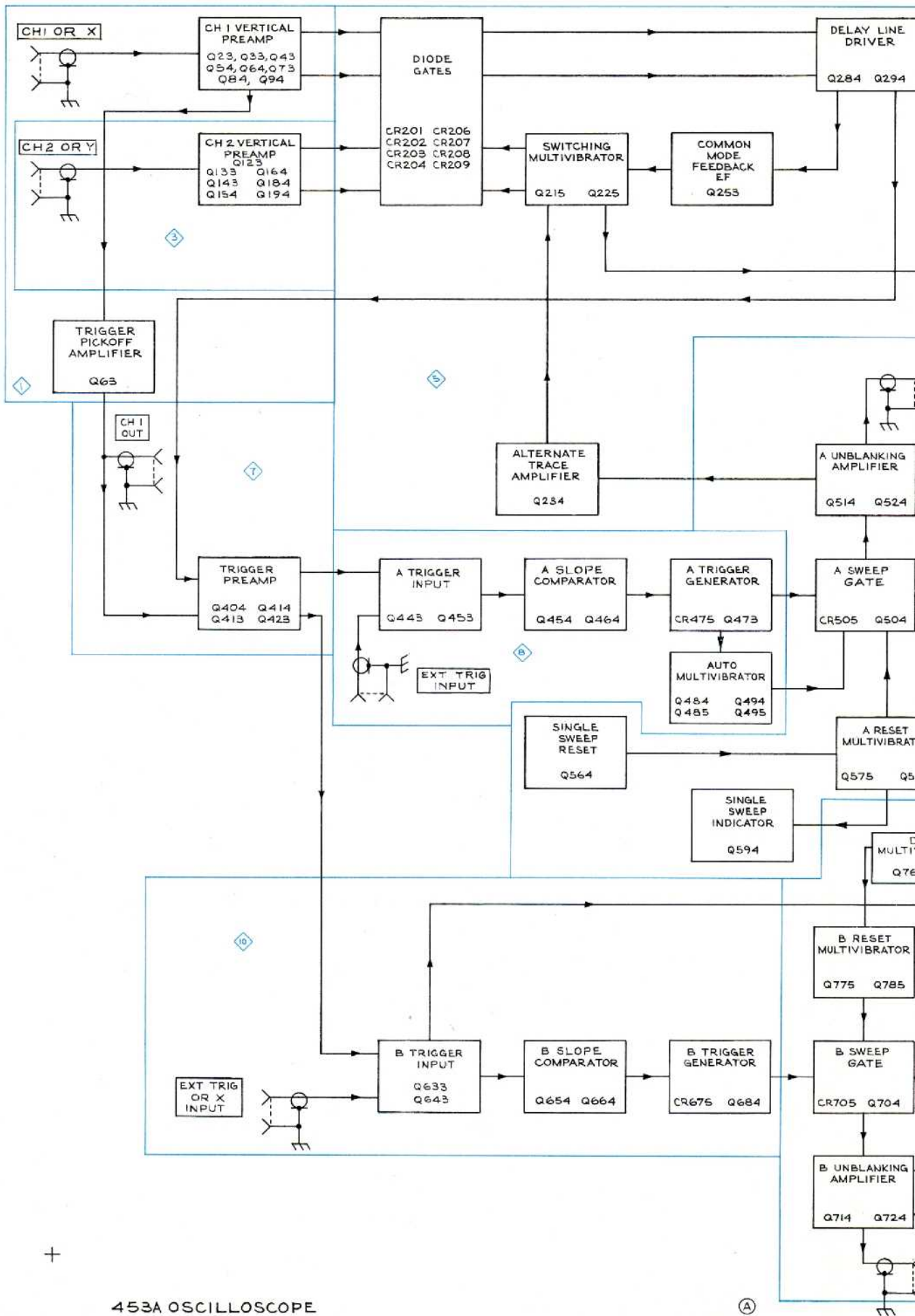
Sweep Controls

DELAY-TIME	5.00
MULTIPLIER	
A TIME/DIV	1 ms
B TIME/DIV	.2 ms
A VAR	CAL
A SWEEP MODE	AUTO TRIG
B SWEEP MODE	TRIGGERABLE AFTER DELAY TIME
HORIZ DISPLAY	A
MAG	OFF
A SWEEP LENGTH	FULL
POSITION	Midrange
FINE	Midrange
POWER	ON

Side-Panel Controls

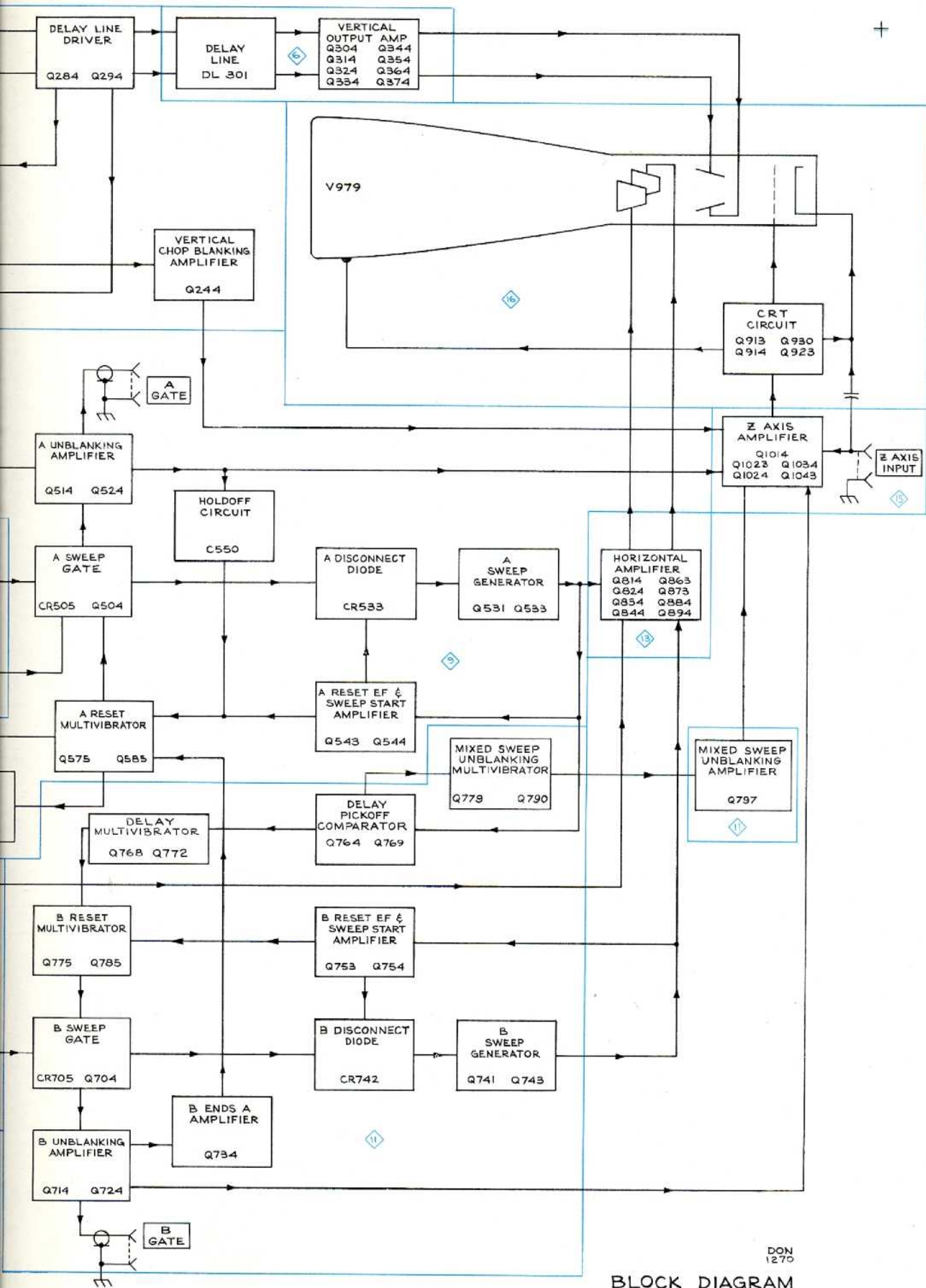
B TIME/DIV	CAL
VARIABLE	
CALIBRATOR	1.0V

All voltages given on the diagrams are in volts. Waveforms shown are actual waveform photographs taken with a Tektronix Oscilloscope Camera System and Projected Graticule. Readouts are simulated in larger-than-normal type. Voltages and waveforms on the diagrams (shown in blue) are not absolute and may vary between instruments because of differing component tolerances, internal calibration or front-panel control settings.



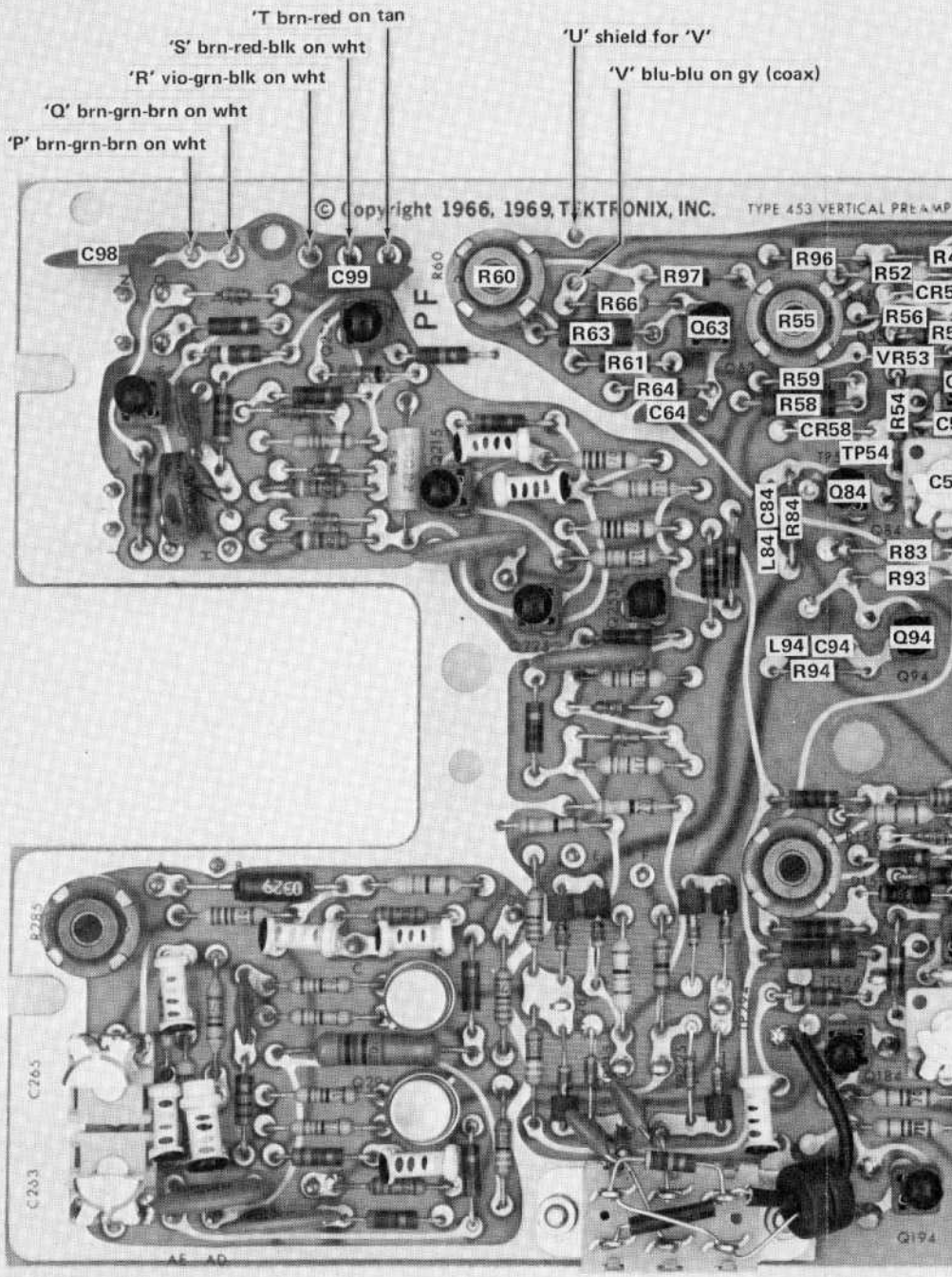
453A OSCILLOSCOPE

(A)



BLOCK DIAGRAM

DON 1270
BLOCK DIAGRAM



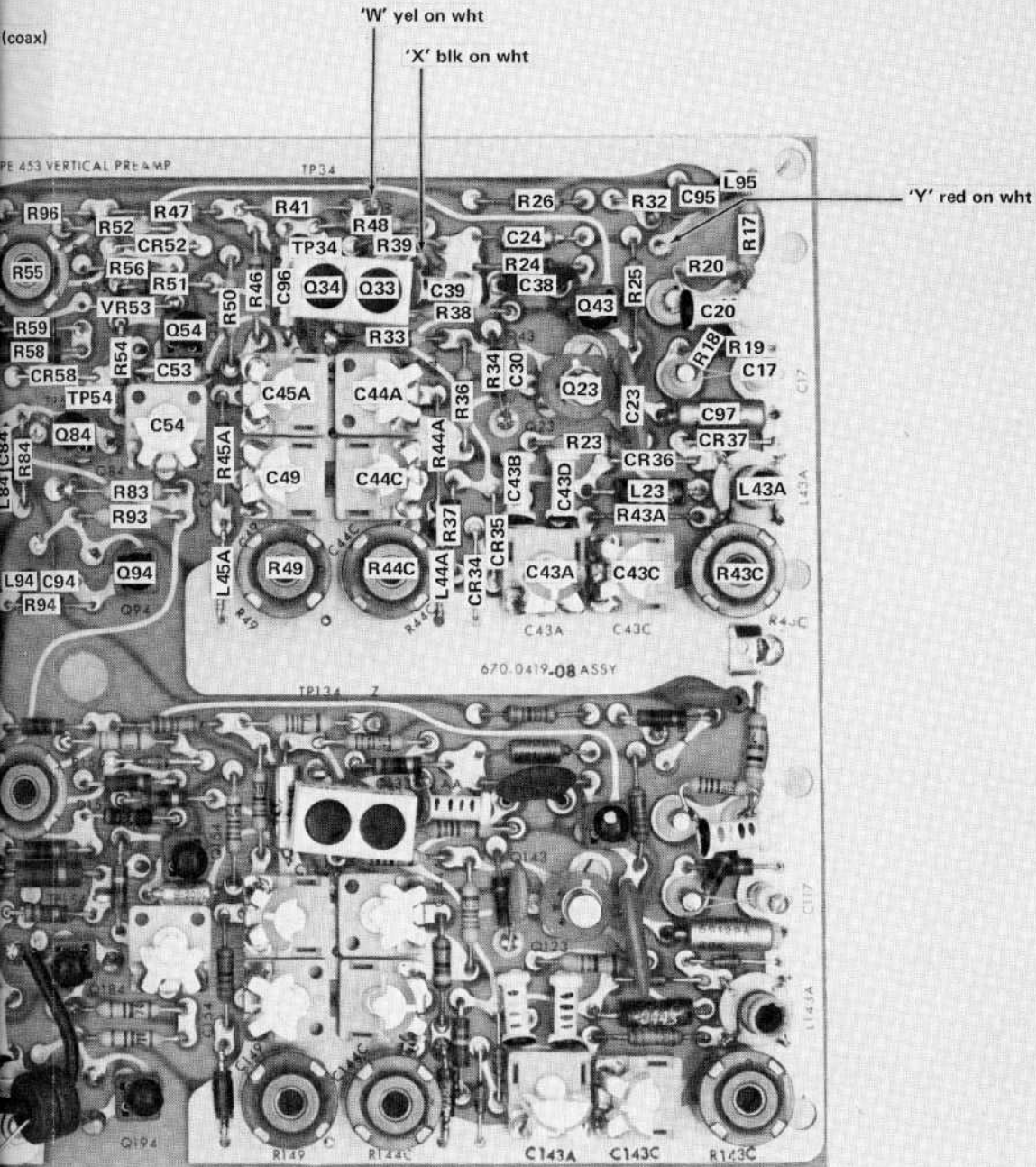
NOTE:
 C18, CR18, R16, R21, R71, R76, R81, R91
 mounted on rear of board.

See Figs. 8-2 and 8-3 for location of parts not shown.

Fig. 8-1. P/O A1. Partial Vertical Preamp circuit board.

(coax)

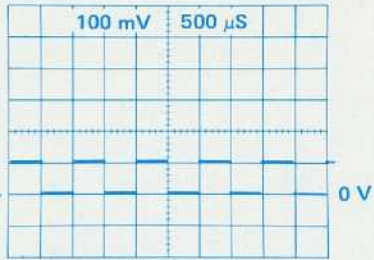
PE 453 VERTICAL PREAMP



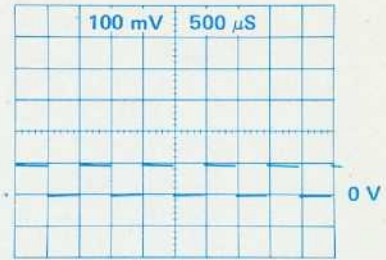
Location of parts not identified here.

Vertical Preamp circuit board.

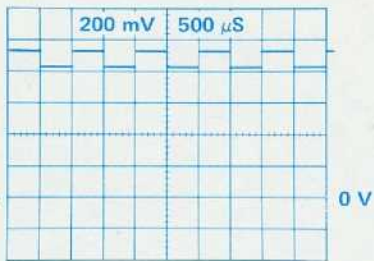
1



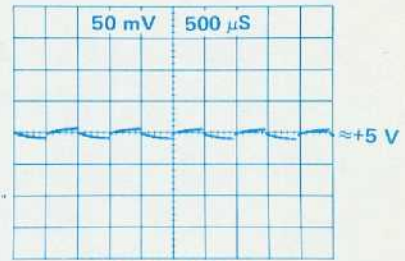
2



3

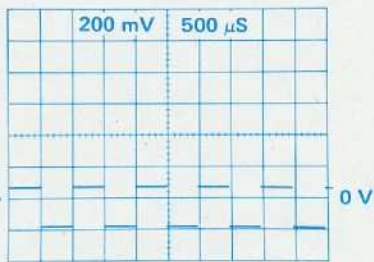


4

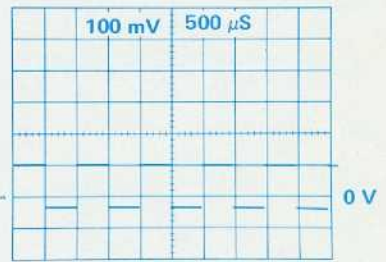


AC COUPLED

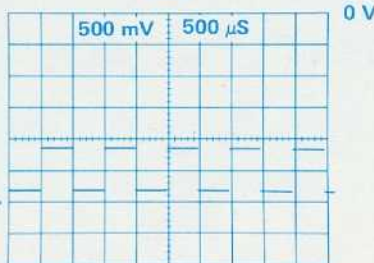
5



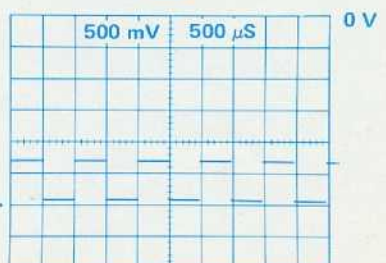
6

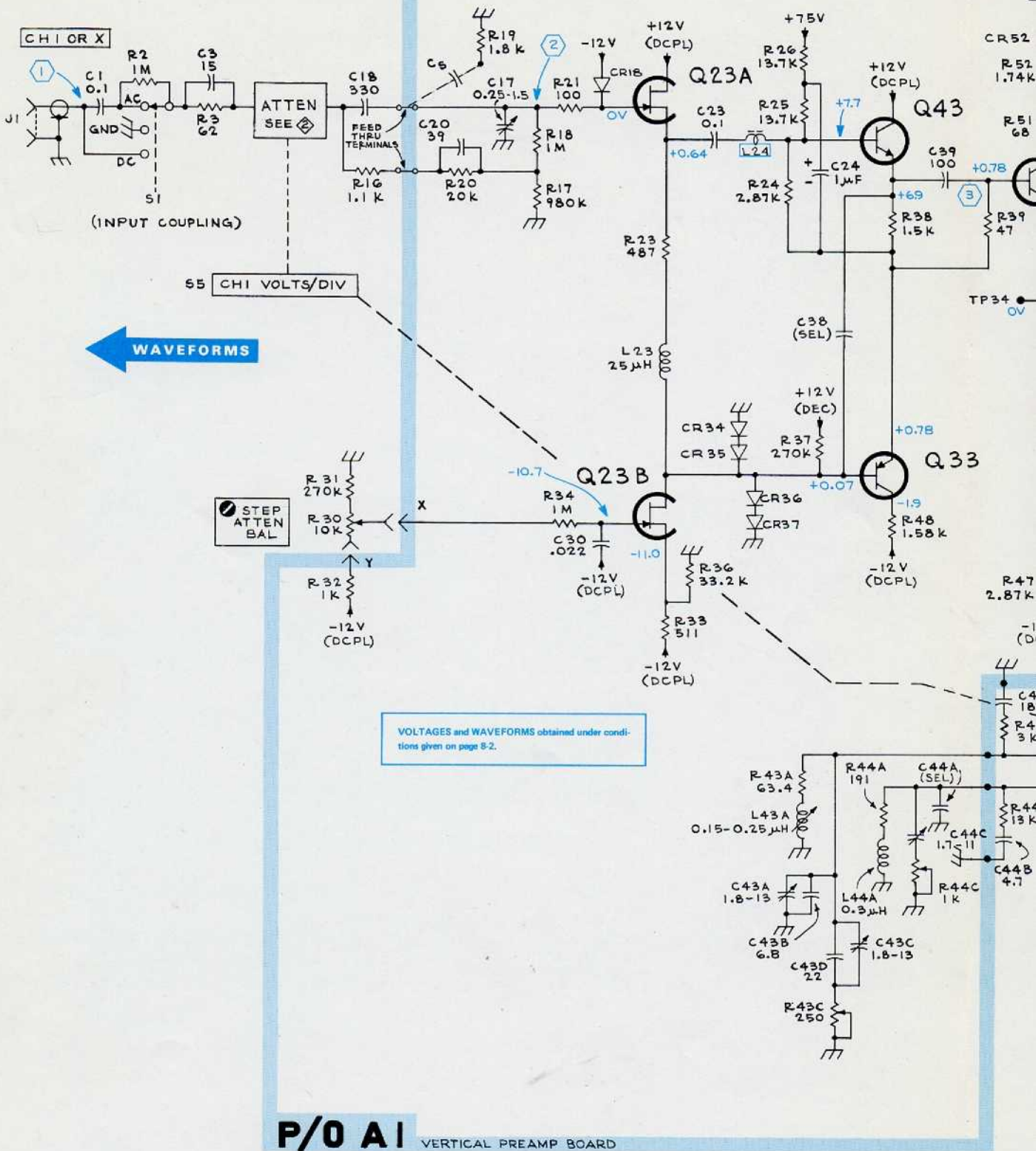


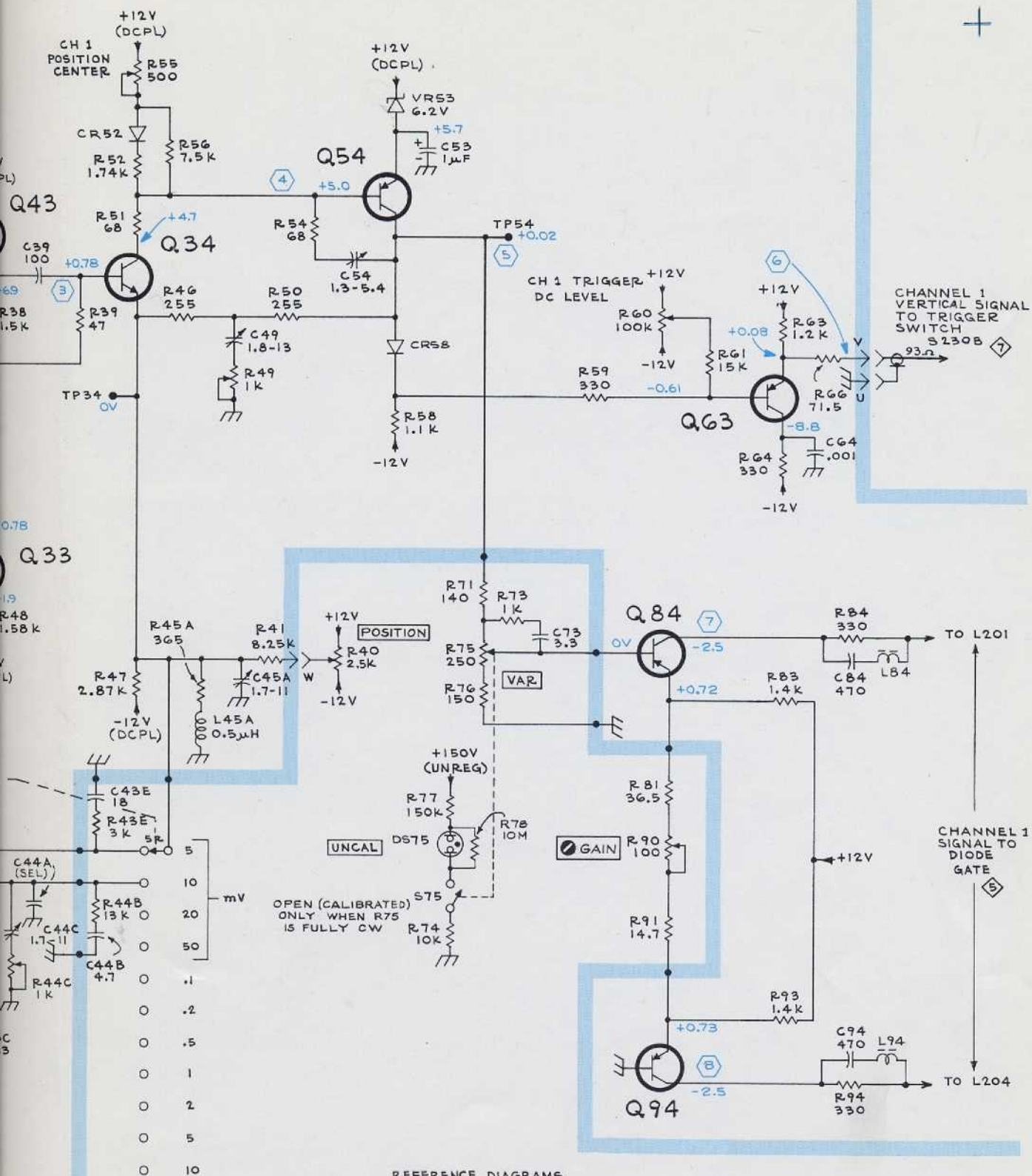
7



8



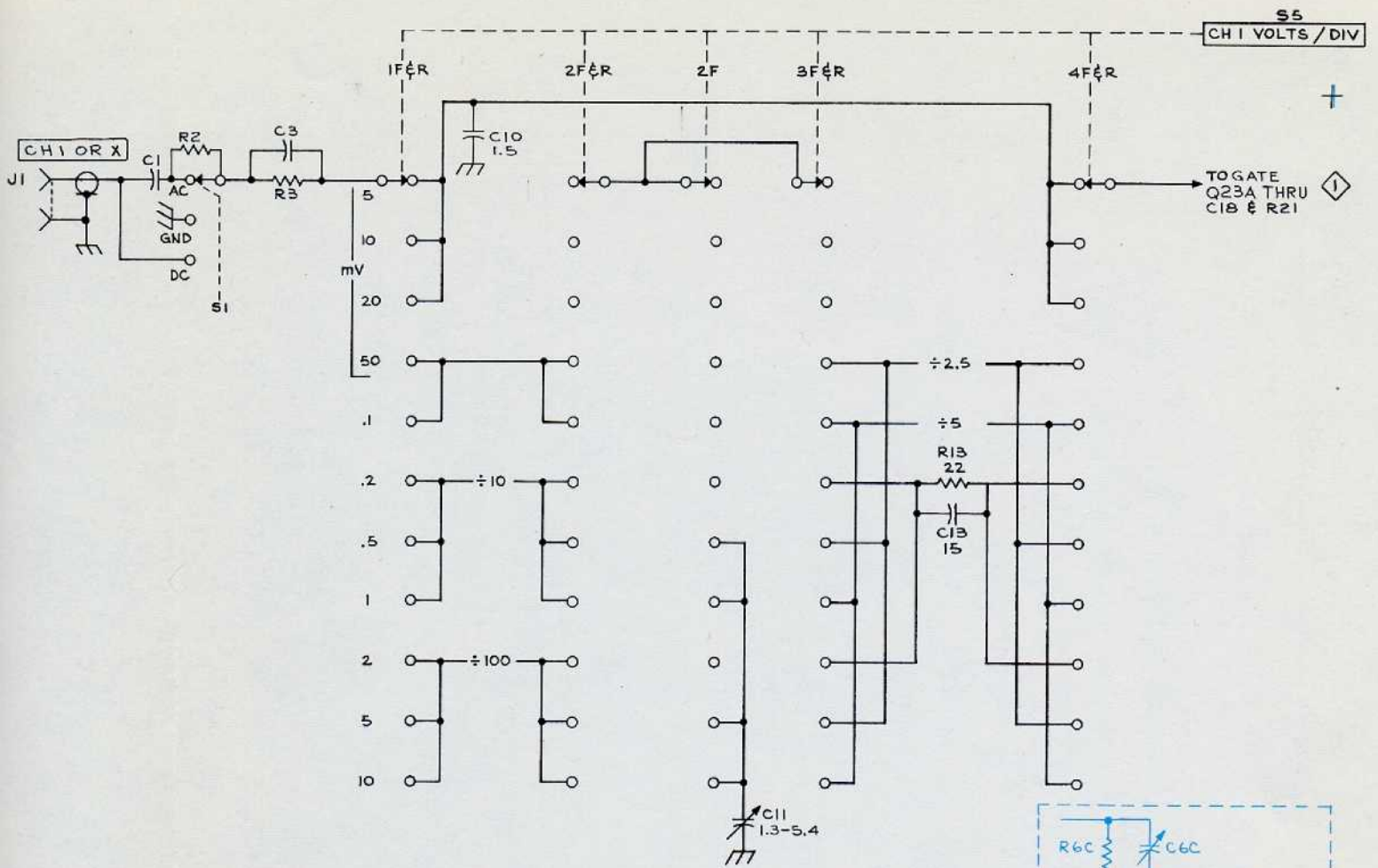




CHANNEL 1 VERTICAL PREAMP

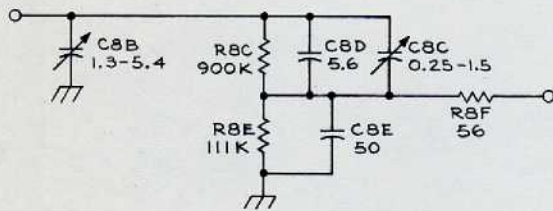
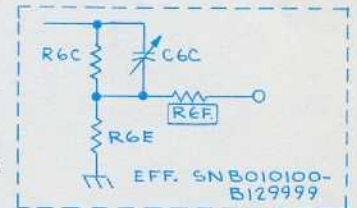
1071 TRN

CHANNEL 1
VERTICAL PREAMP

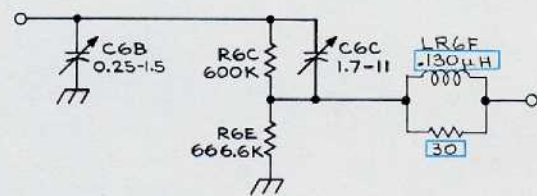


÷ 10

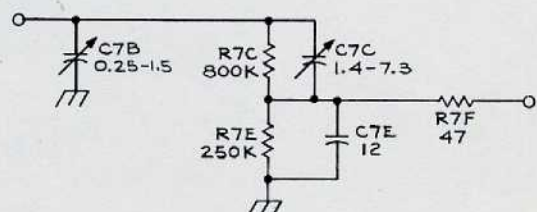
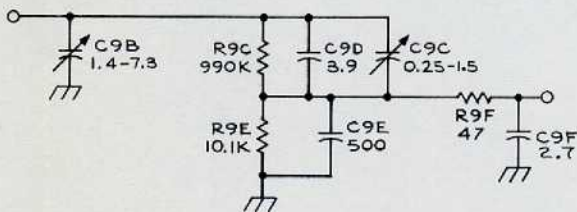
÷ 2.5



÷ 100



÷ 5



REFERENCE DIAGRAMS

① CHANNEL I VERTICAL PREAMP

SEE PARTS LIST FOR EARLIER VALUES AND SERIAL NUMBER RANGES OF PARTS MARKED WITH BLUE OUTLINE.

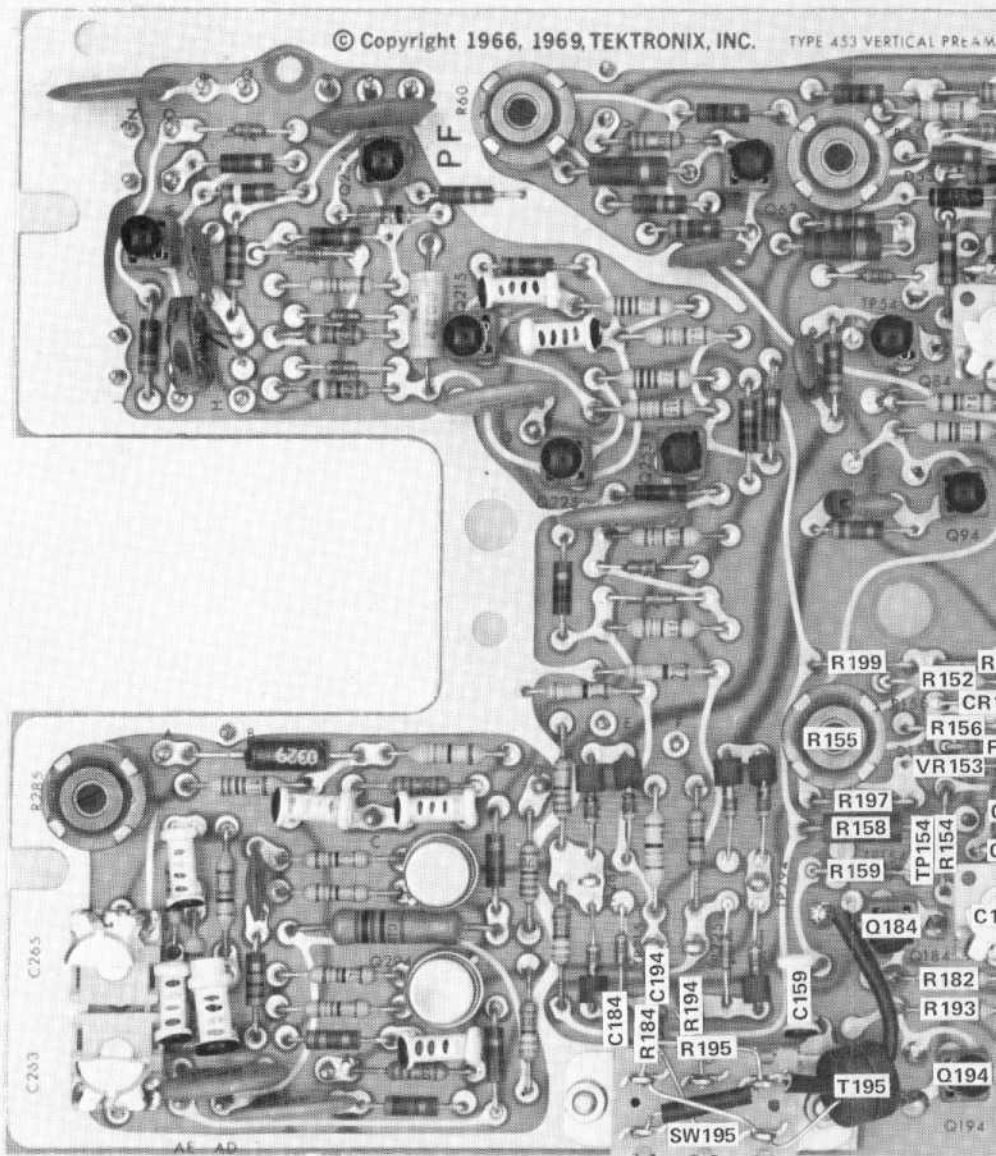
+

453A OSCILLOSCOPE

ⓑ

CHANNEL I ATTENUATORS ②

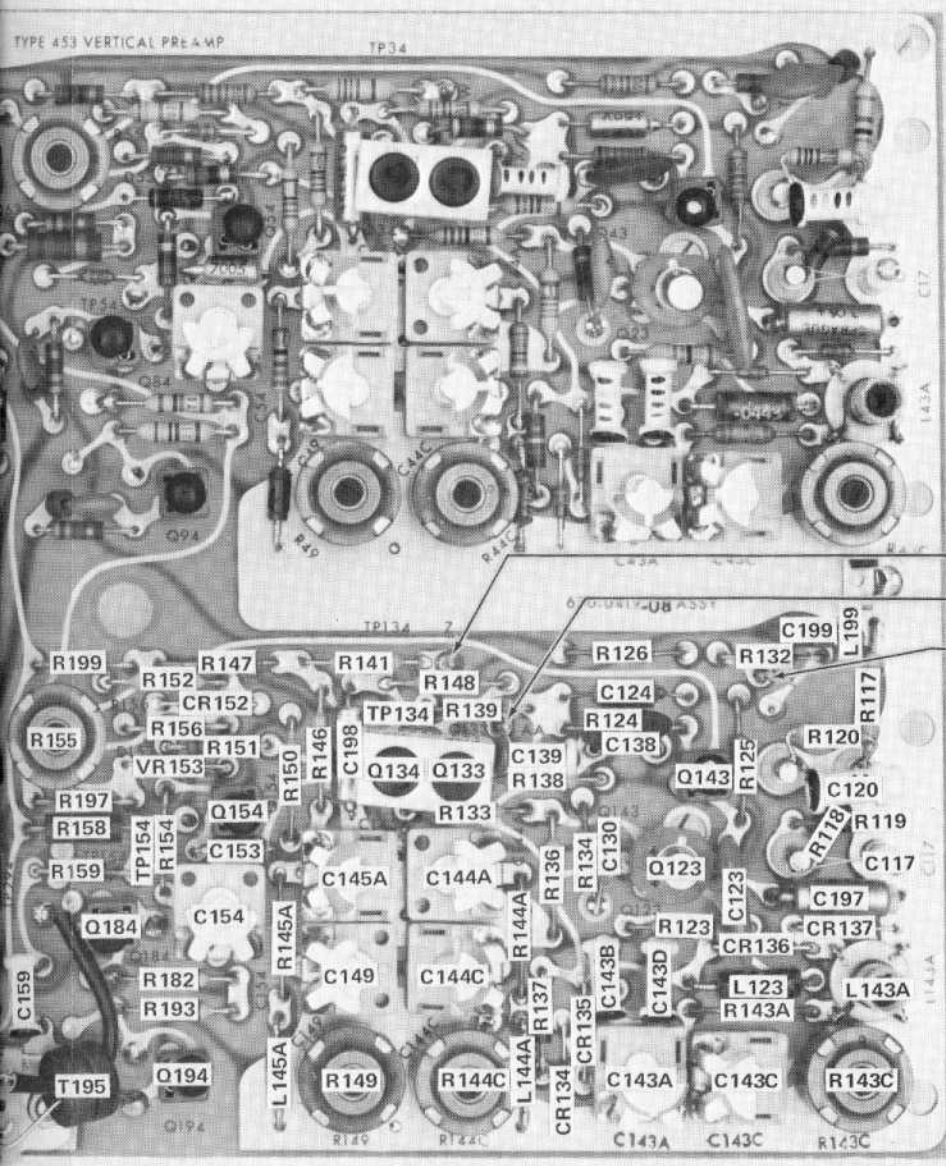
DON
1171



NOTE:
 CR118, R116, R121, R171, R176, R181, R191
 mounted on rear of board.

See Figs. 8-1 and 8-3 for location of parts not shown.

Fig. 8-2. P/O A1. Partial Vertical Preamp

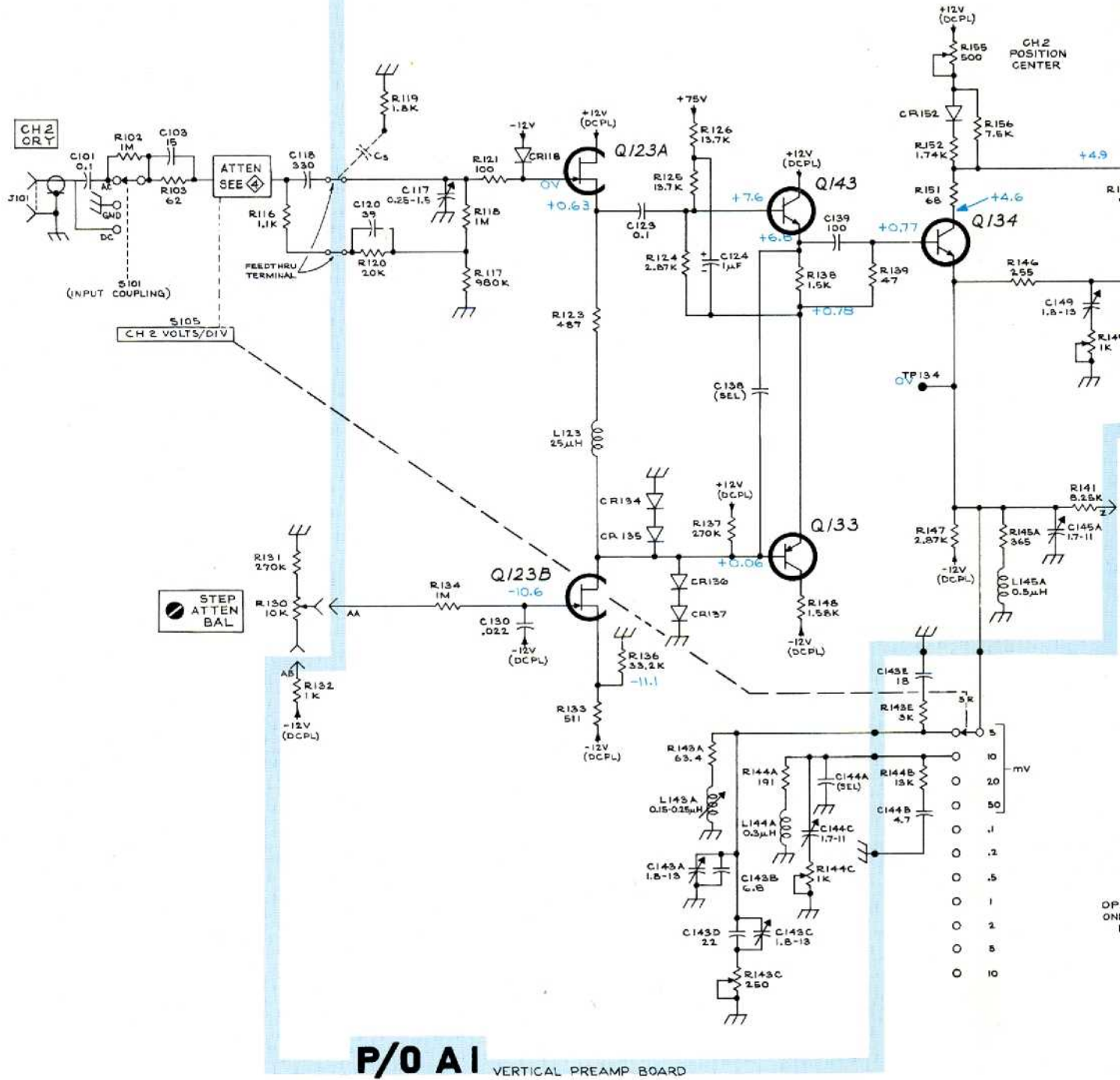


- 'Z' yel on wht
- 'AA' blk on wht
- 'AB' red on wht

8 for location of parts not identified here.



Partial Vertical Preamp circuit board.



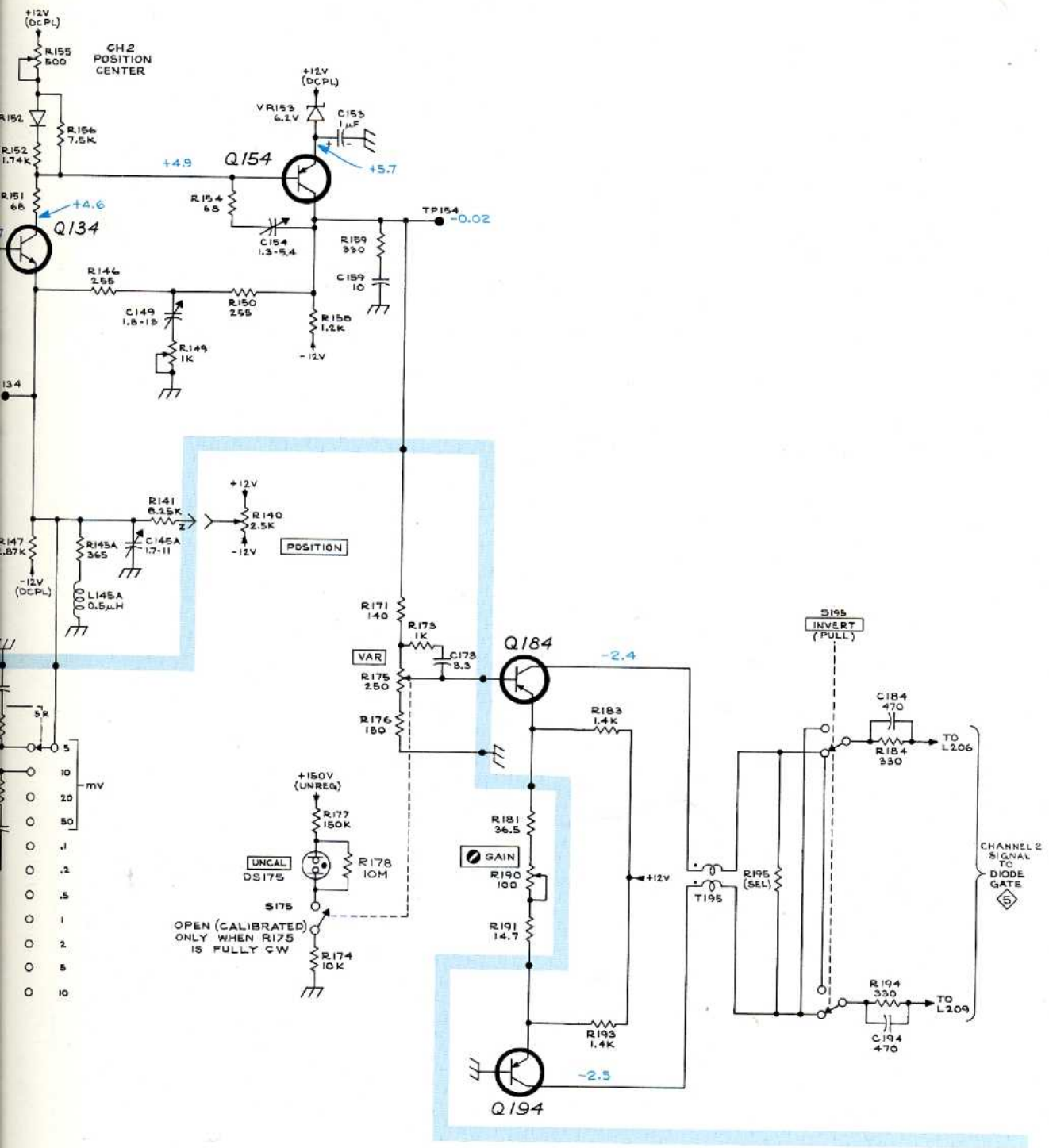
REFERENCE DIAGRAMS

- 4 CHANNEL 2 ATTENUATORS
- 5 VERTICAL SWITCHING

SEE PARTS LIST FOR SEMICONDUCTOR TYPES.

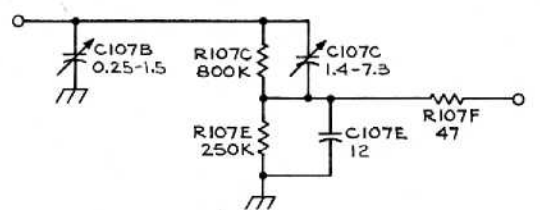
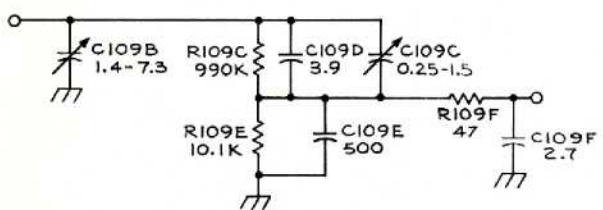
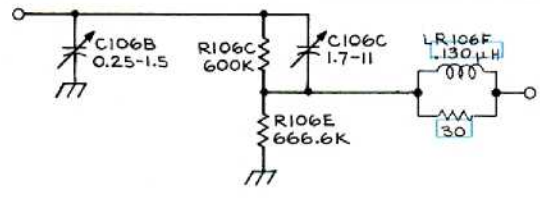
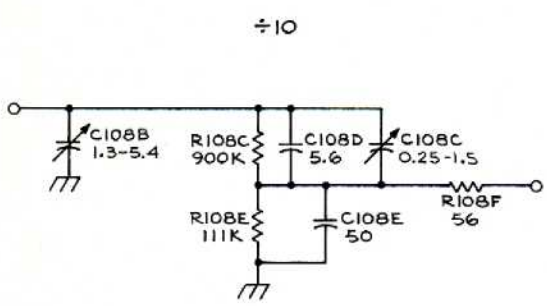
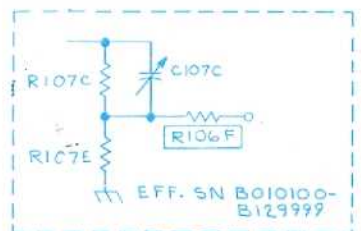
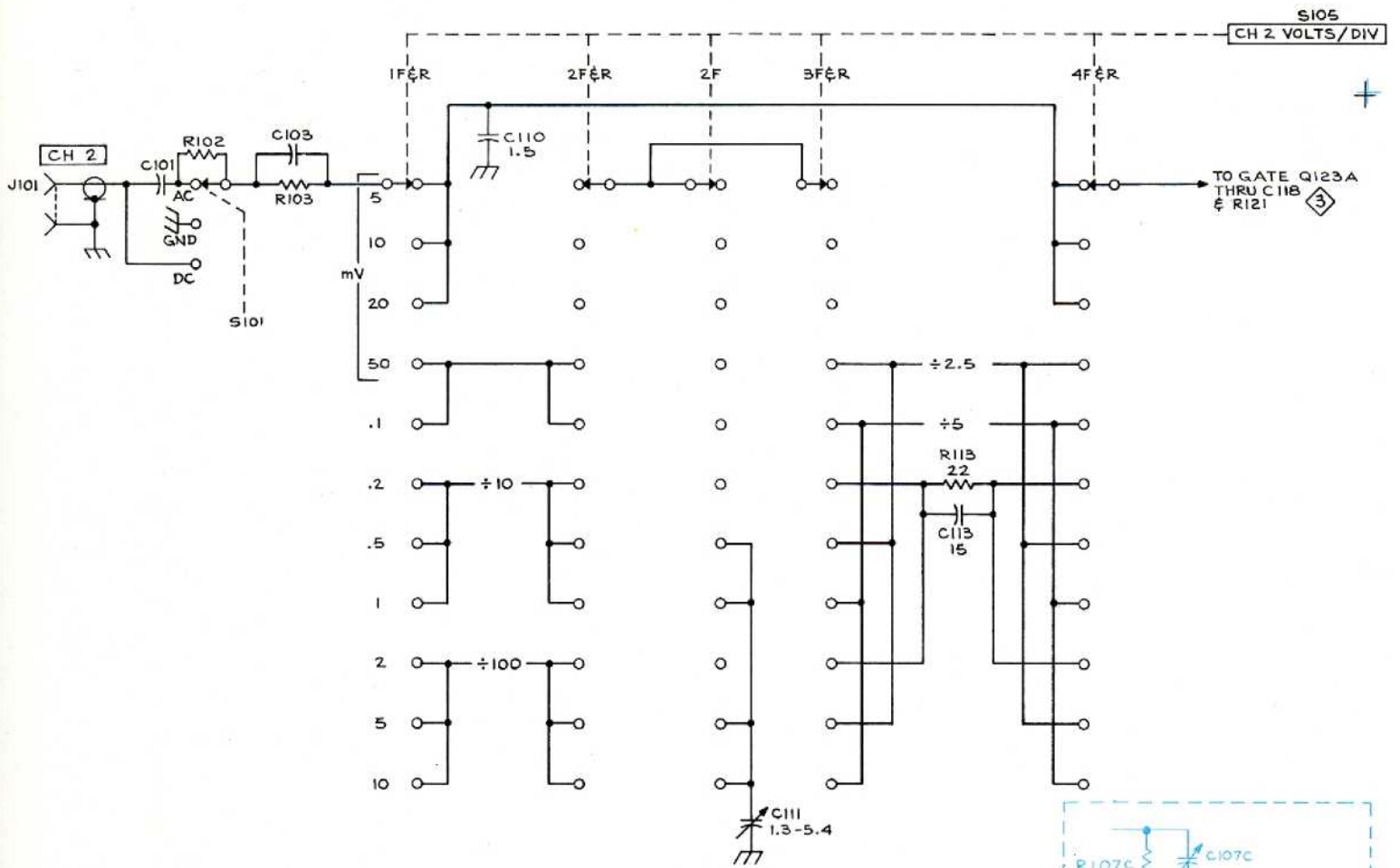
VOLTAGES obtained under conditions given on page B2 except as follows (see diagram 4) for typical WAVEFORMS:

MODE CH 2



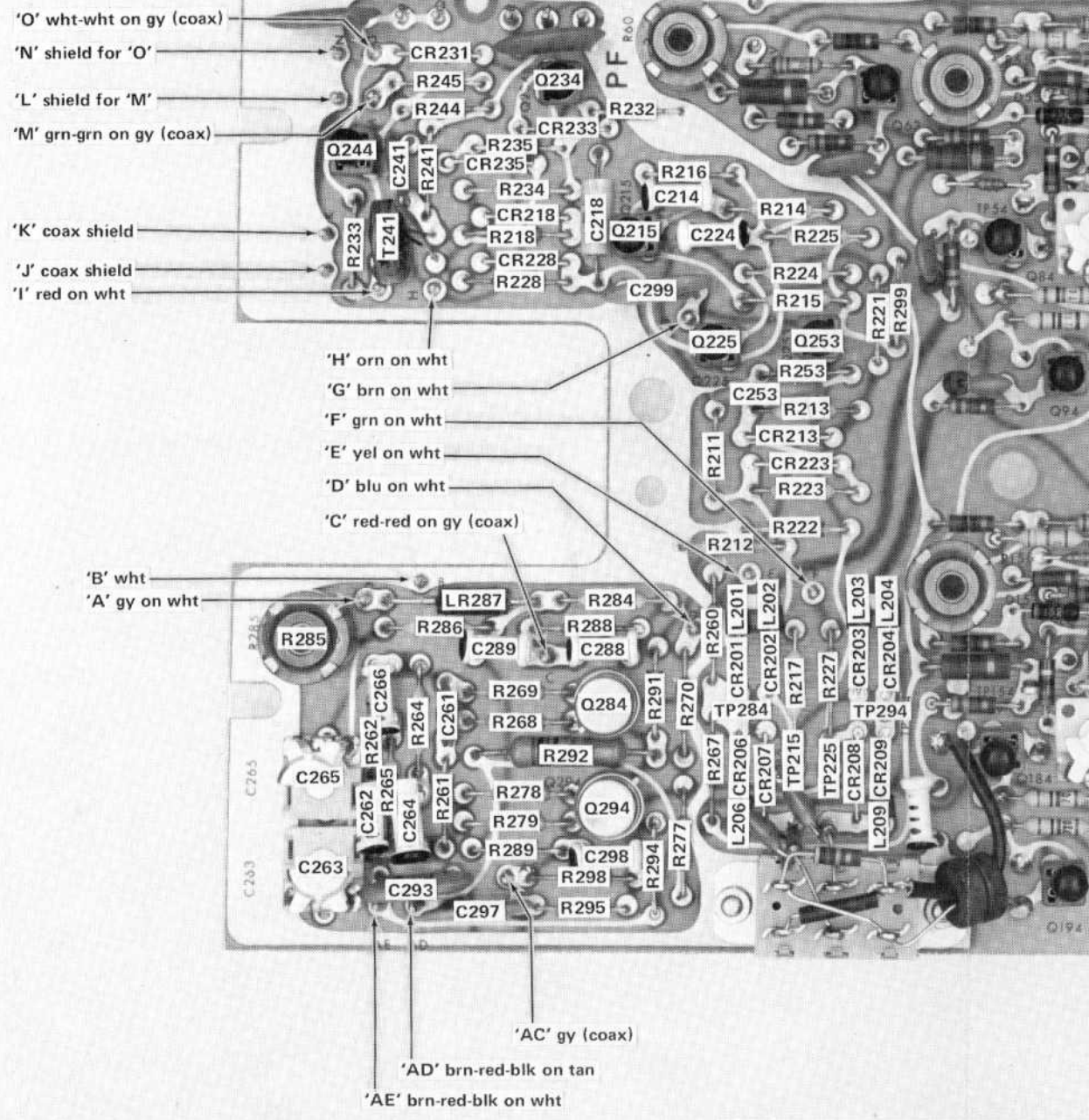
See page 8-2
typical WAVE.

CMD
1270



REFERENCE DIAGRAMS
 ③ CHANNEL 2 VERTICAL PREAMP

SEE PARTS LIST FOR EARLIER VALUES AND SERIAL NUMBER RANGES OF PARTS MARKED WITH BLUE OUTLINE

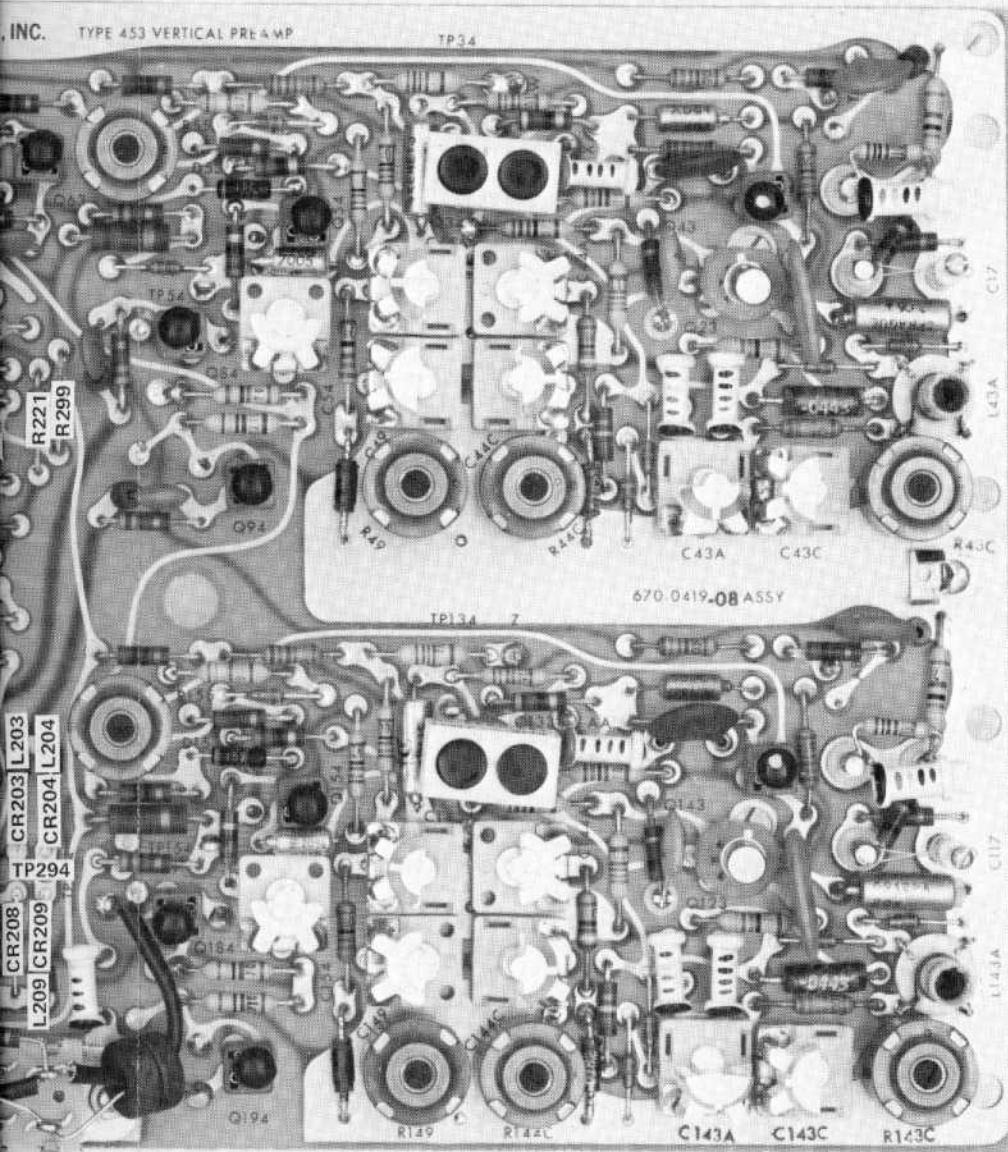


See Figs. 8-1 and 8-2 for location of parts not

Fig. 8-3. P/O A1. Partial Vertical Preamp

INC. TYPE 453 VERTICAL PREAMP

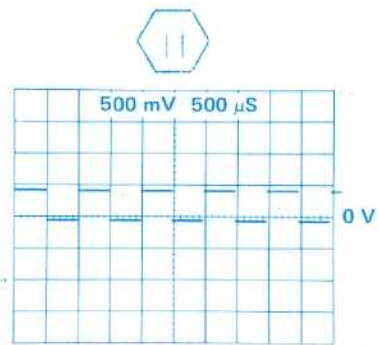
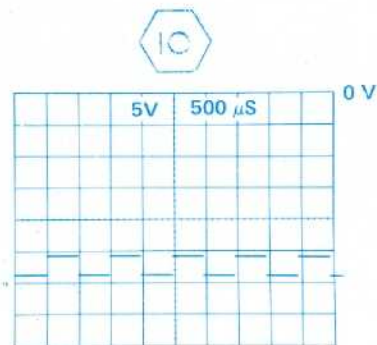
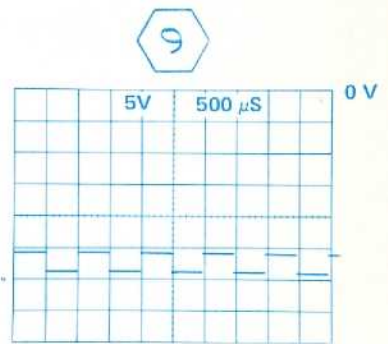
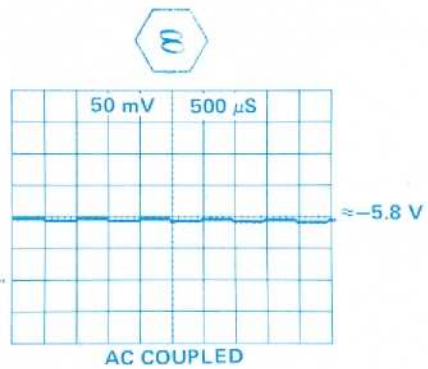
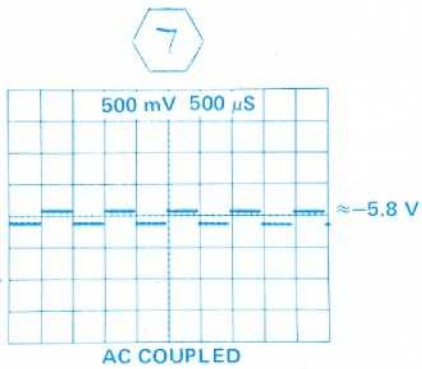
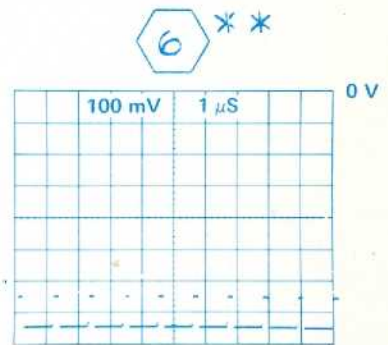
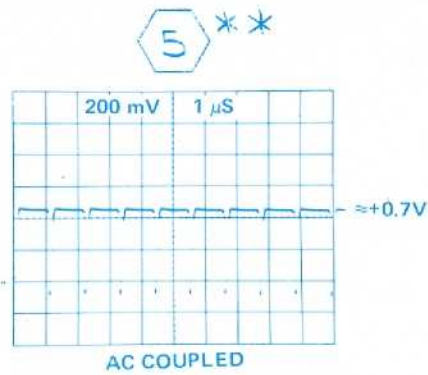
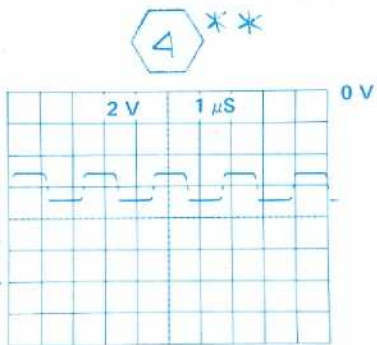
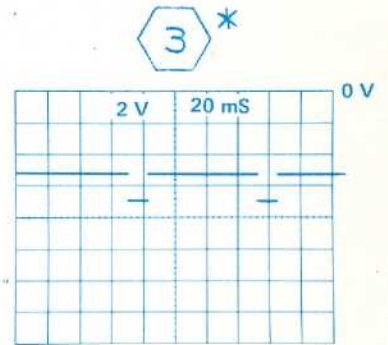
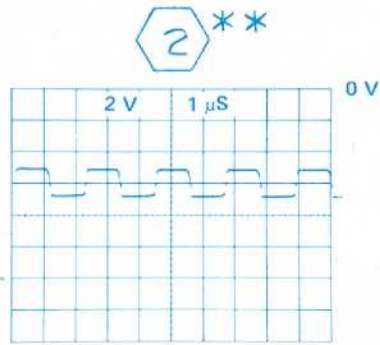
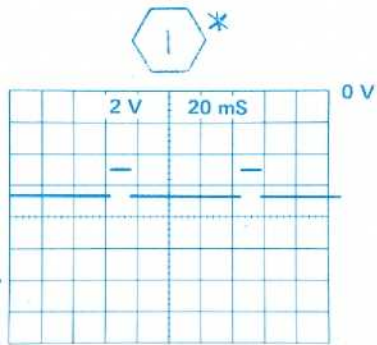
TP34

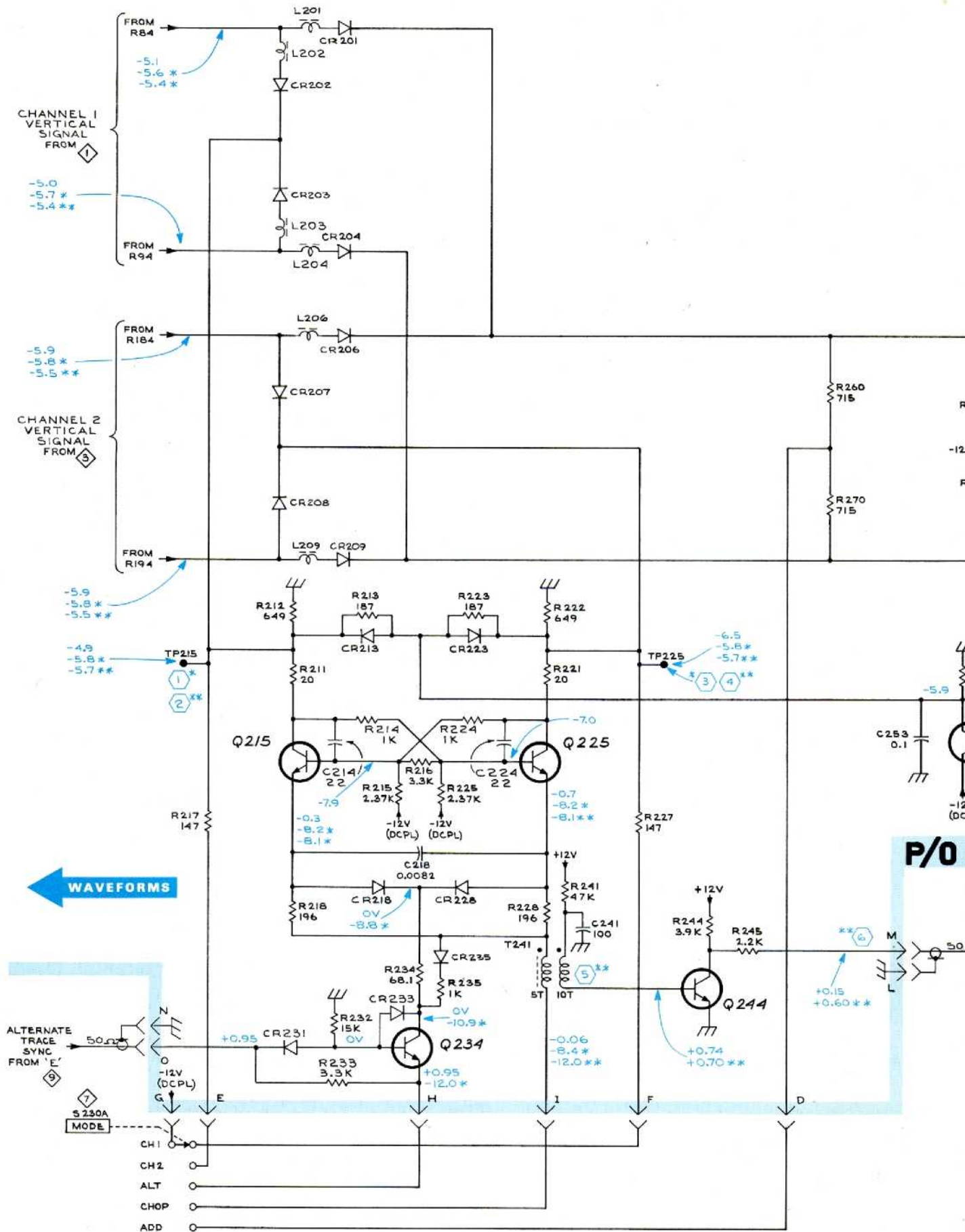


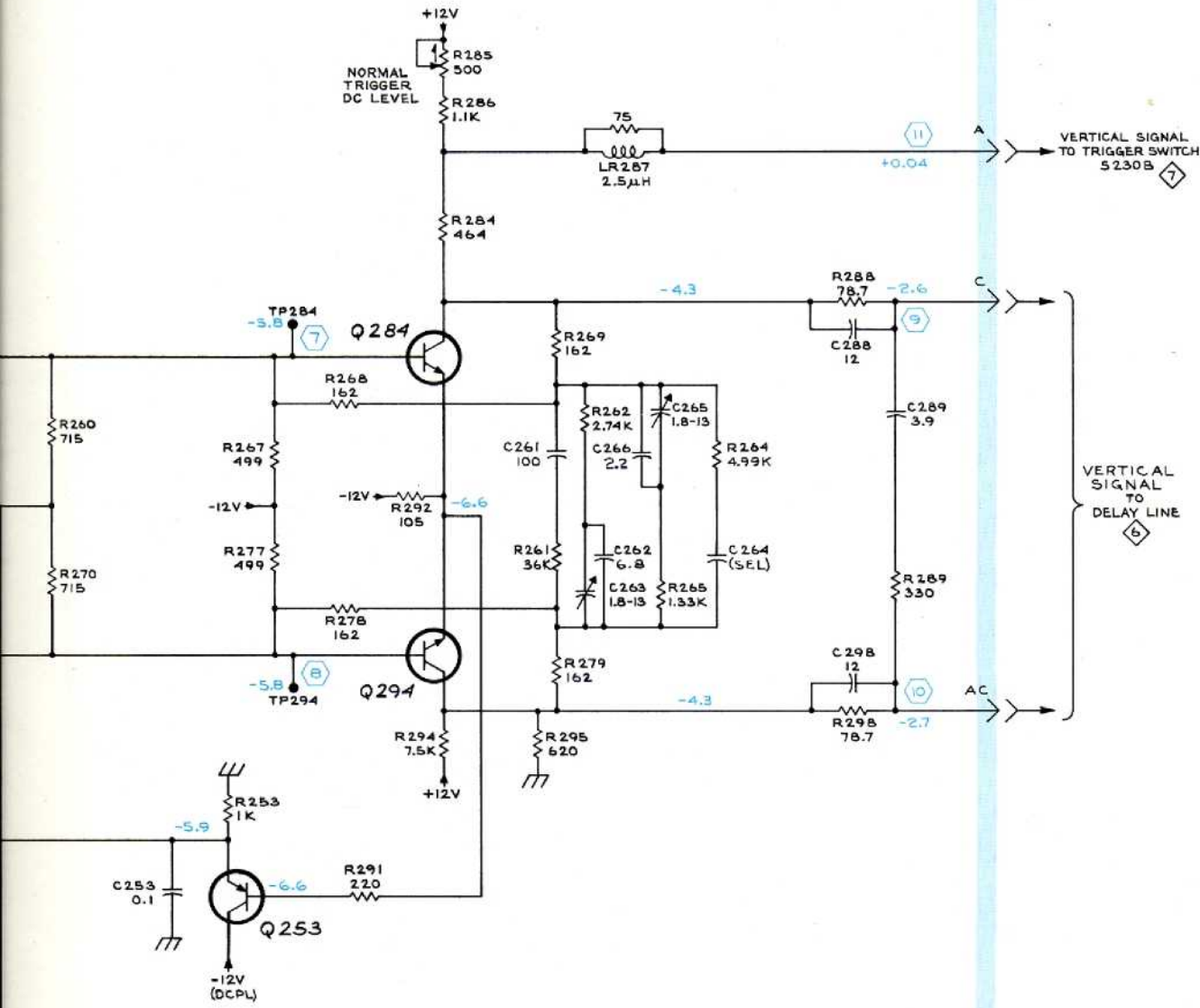
and 8-2 for location of parts not identified here.



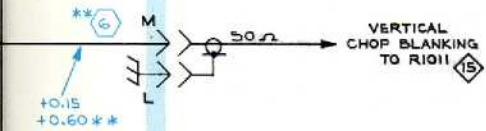
D A1. Partial Vertical Preamp circuit board.







P/O A1 VERTICAL PREAMP BOARD



VOLTAGES and WAVEFORMS obtained under conditions given on page B-2 except as follows:

*MODE ALT
 **MODE CHOP

(Test oscilloscope triggered from applied signal for waveforms marked * and **)

REFERENCE DIAGRAMS

- ① CHANNEL 1 VERTICAL PREAMP
- ③ CHANNEL 2 VERTICAL PREAMP
- ⑥ VERTICAL OUTPUT AMPLIFIER
- ⑦ TRIGGER PREAMP
- ⑨ A SWEEP GENERATOR
- ⑮ Z AXIS AMPLIFIER

SEE PARTS LIST FOR SEMICONDUCTOR TYPES

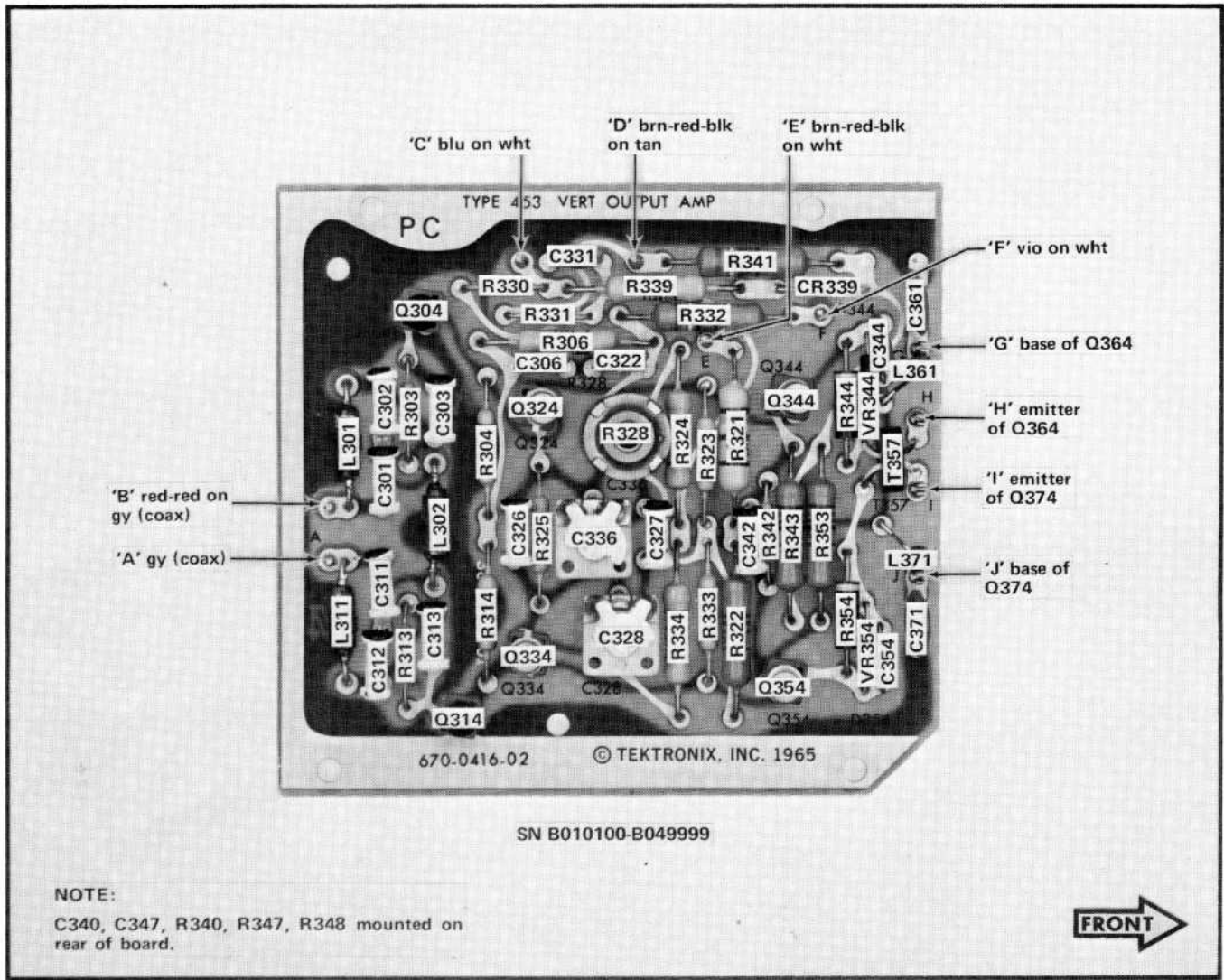


Fig. 8-4A. A-2. Vertical Output Amplifier circuit board.

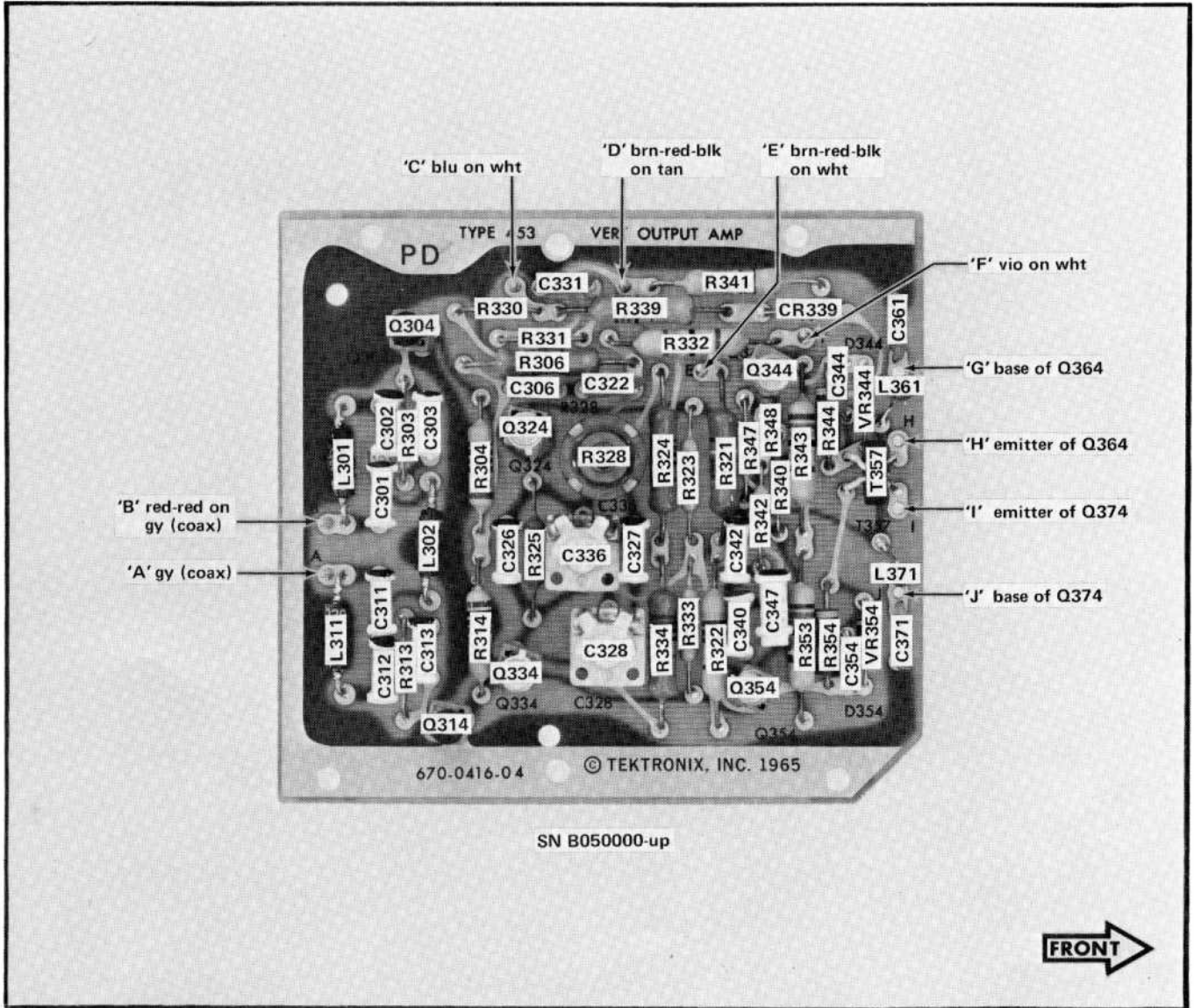
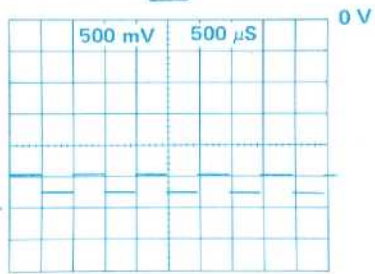
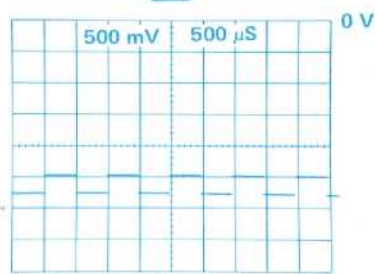


Fig. 8-4B. A-2. Vertical Output Amplifier circuit board.

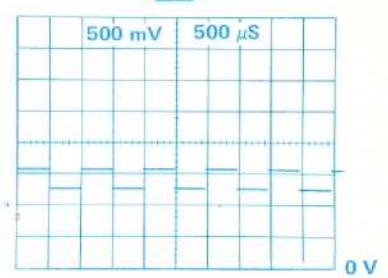
1



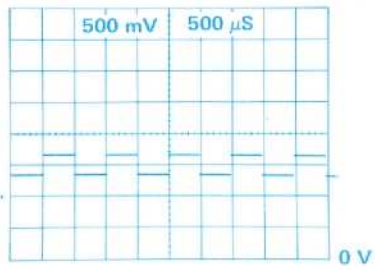
2



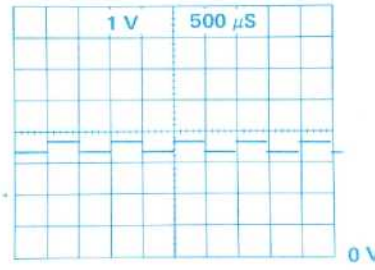
3



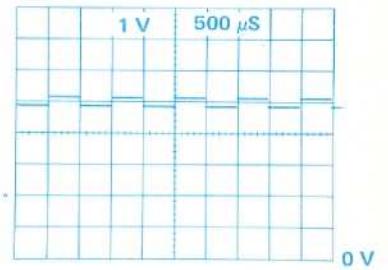
4



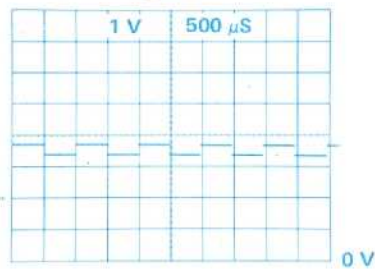
5



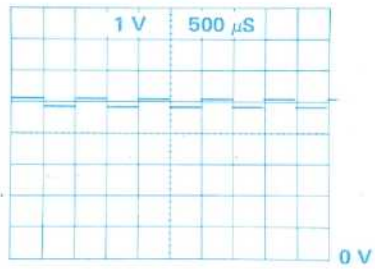
6*



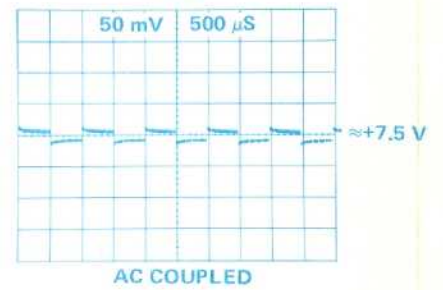
7



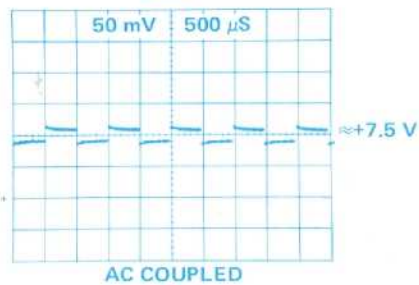
8*



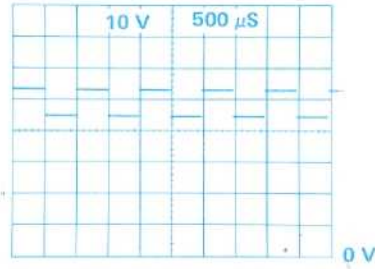
9



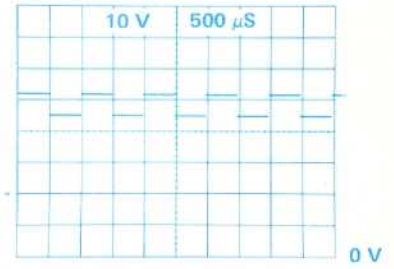
10



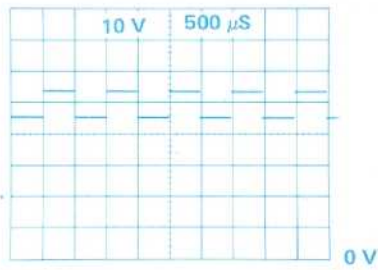
11



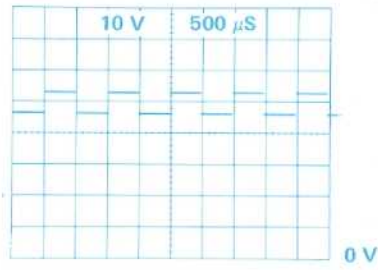
12*



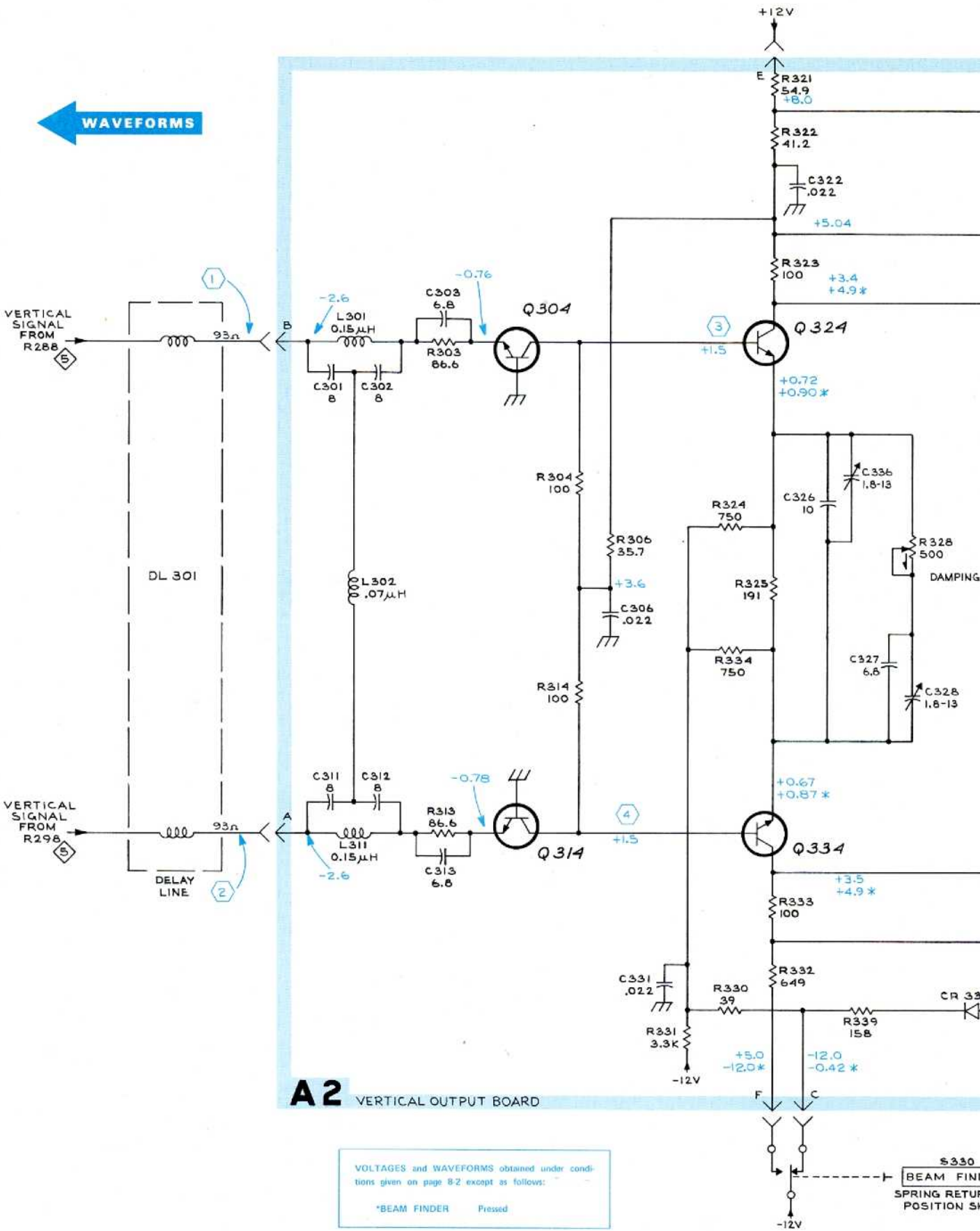
13

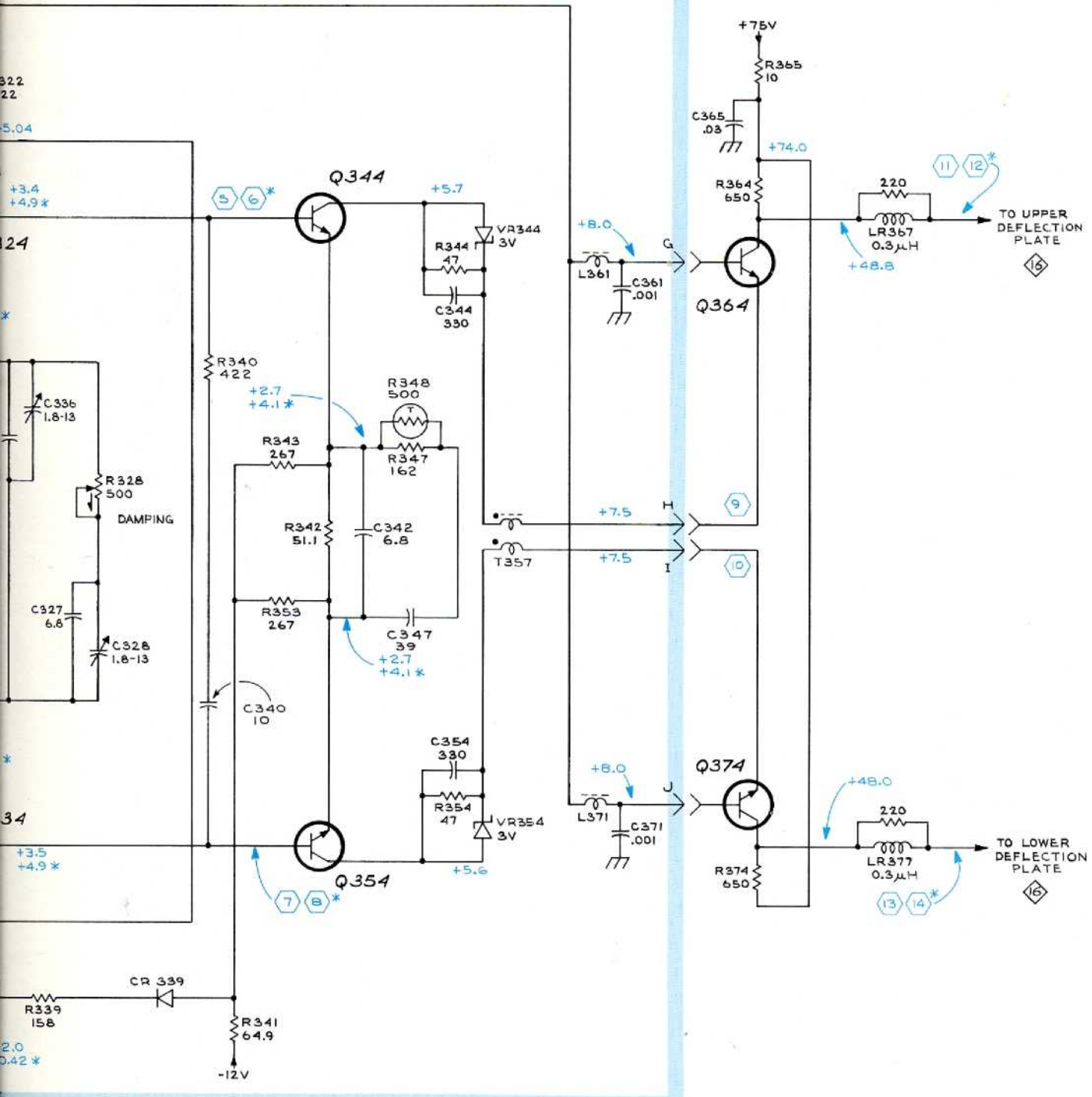


14*



← WAVEFORMS





322
22
5.04
+3.4
+4.9*
24
*
C336
1.8-13
R328
500
DAMPING
C327
6.8
C328
1.8-13
*
34
+3.5
+4.9*
2.0
0.42*
R339
158
CR339
R341
64.9
-12V

S330
BEAM FINDER
SPRING RETURN TO POSITION SHOWN

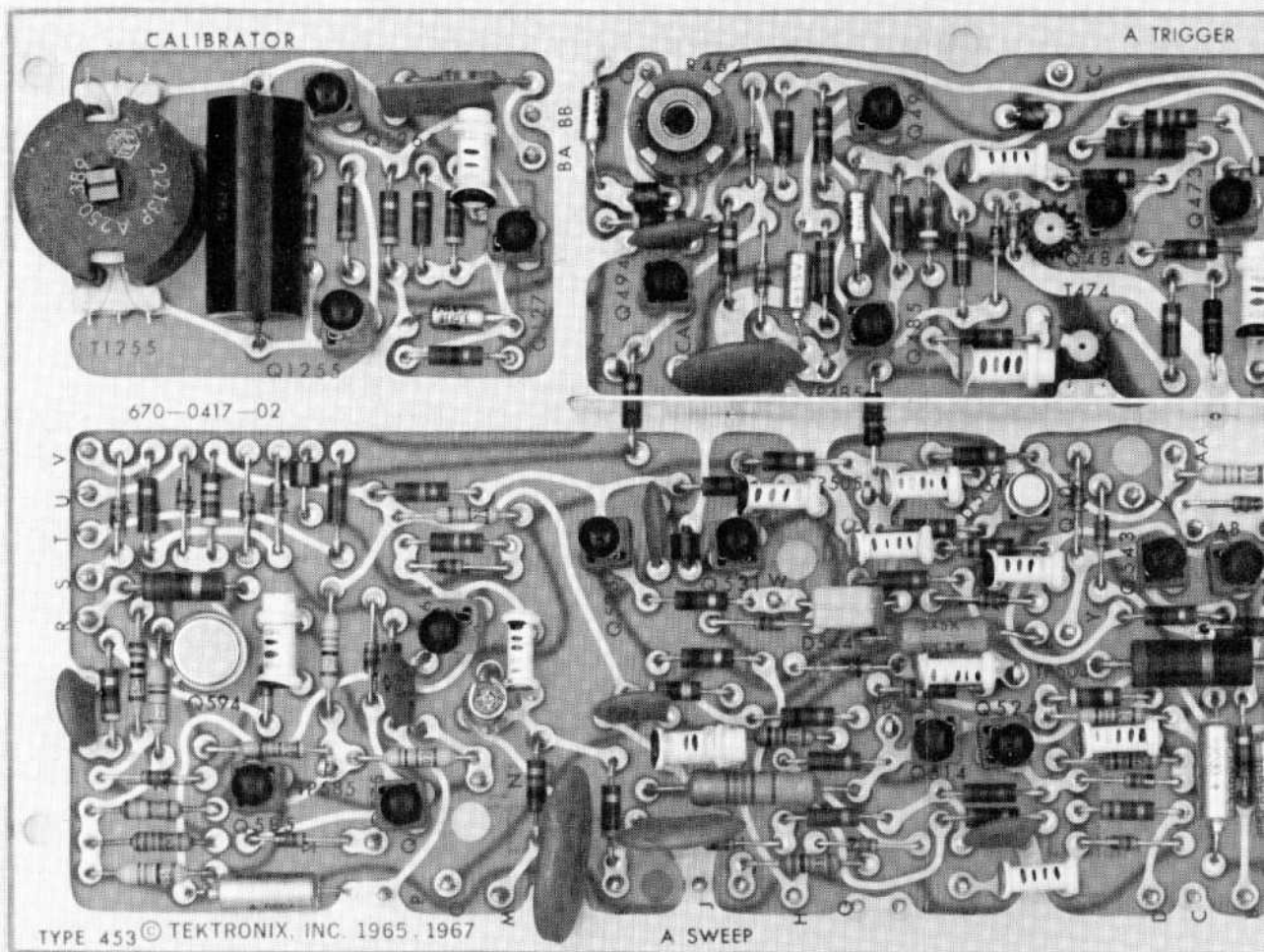
SEE PARTS LIST FOR SEMICONDUCTOR TYPES

- REFERENCE DIAGRAMS
- 5 VERTICAL SWITCHING
 - 13 HORIZONTAL AMPLIFIER
 - 16 CRT CIRCUIT

VERTICAL OUTPUT AMPLIFIER 6

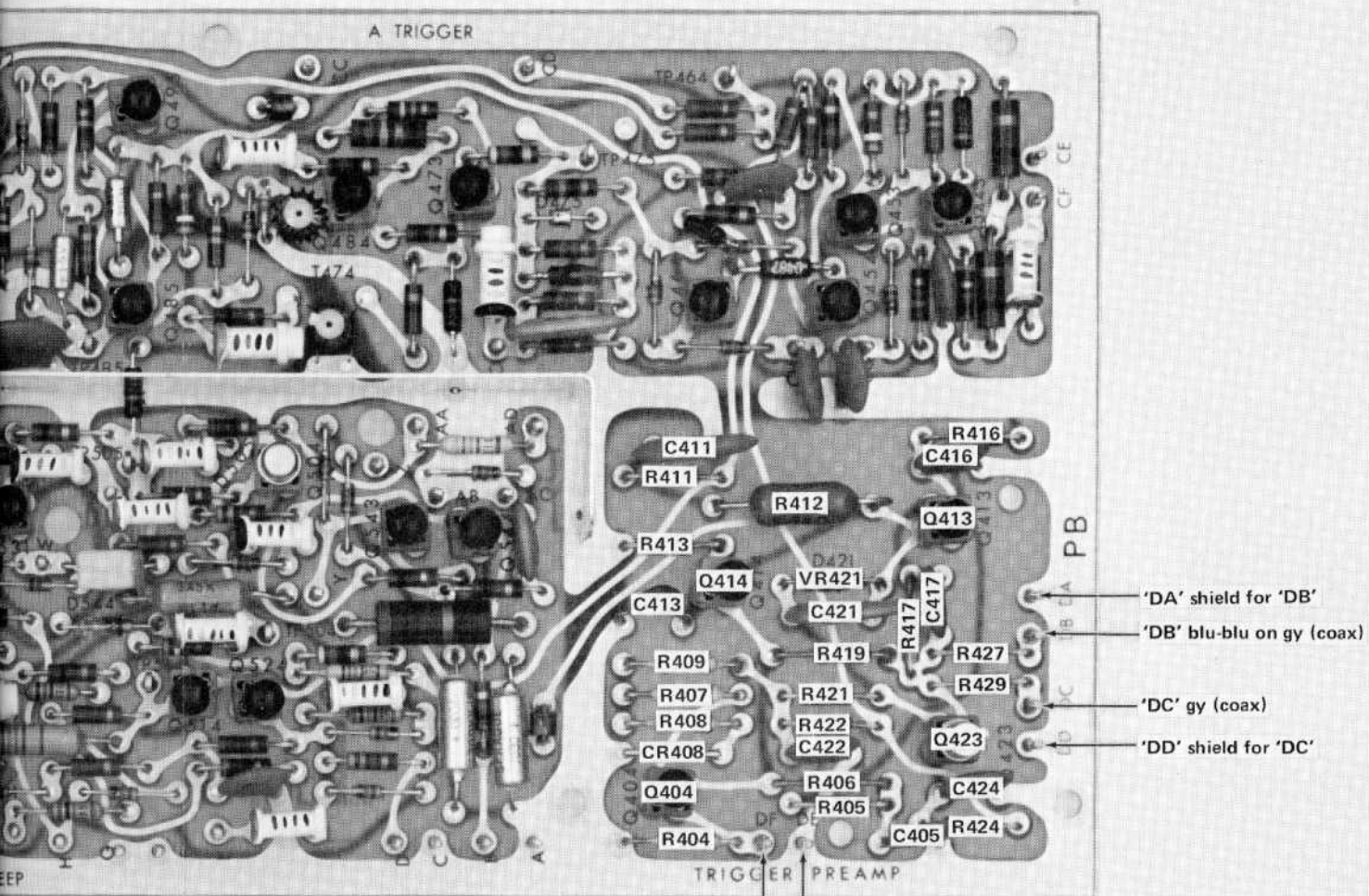
CMD
1270

VERTICAL OUTPUT AMPLIFIER 6



See Figs. 8-6, 8-7 and 8-14 for location for parts not identified here

Fig. 8-5. P/O A3. Partial A Sweep circuit board.

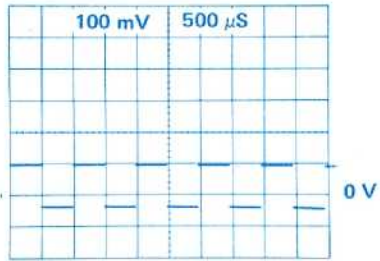


8-6, 8-7 and 8-14 for location for parts not identified here.

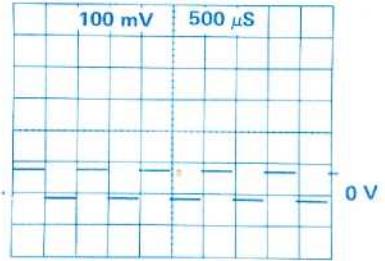


Fig. 8-5. P/O A3. Partial A Sweep circuit board.

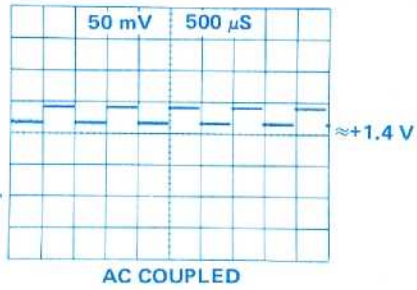
1



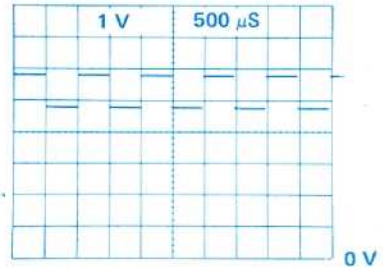
2



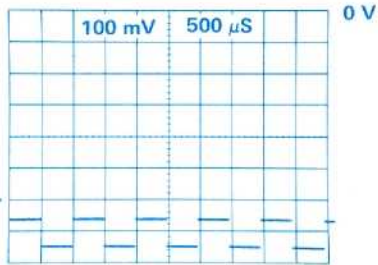
3



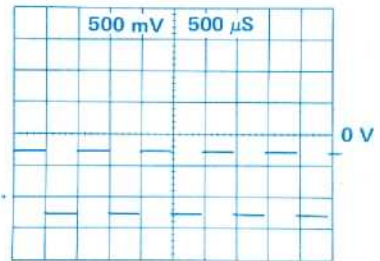
4



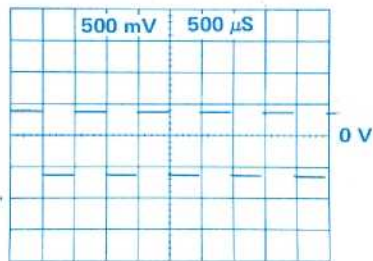
5



6



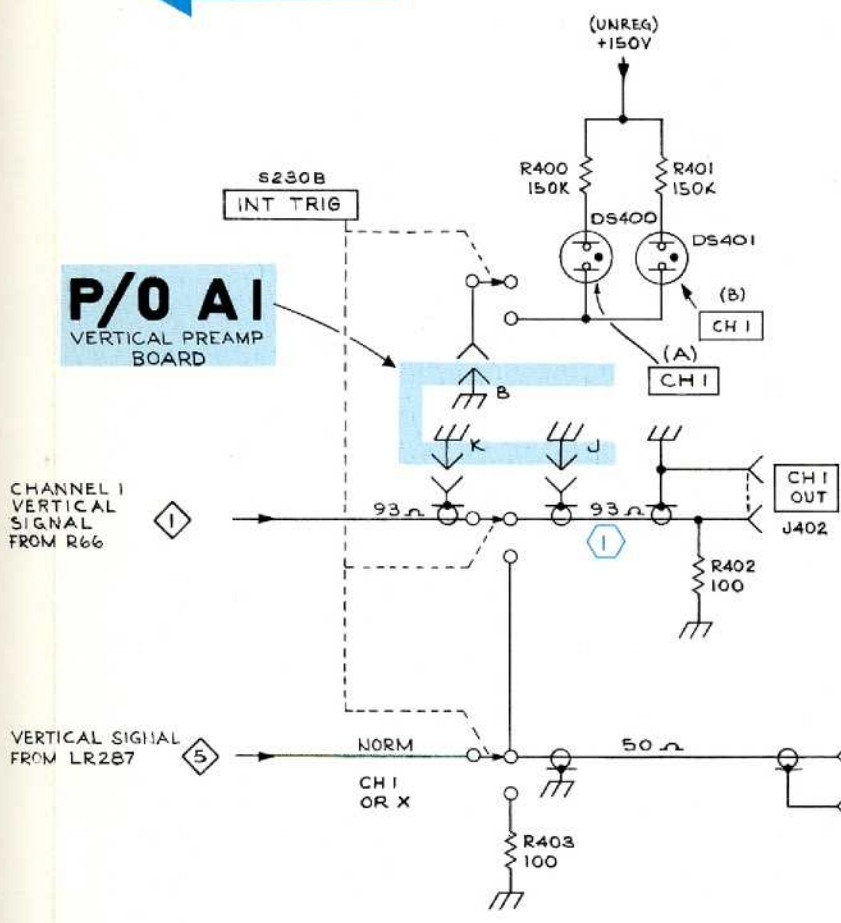
7



CHANN
VERTIC
SIGNA
FROM R

VERTIC
FROM L

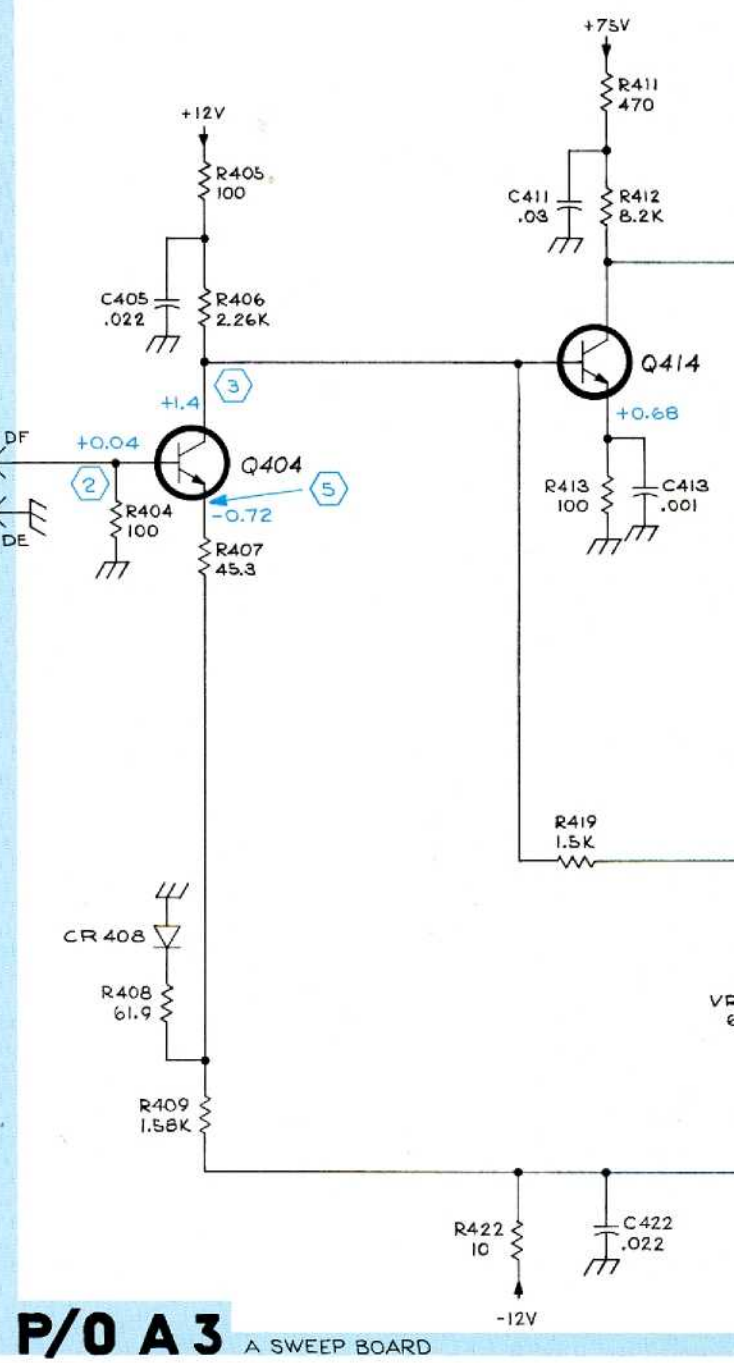
WAVEFORMS



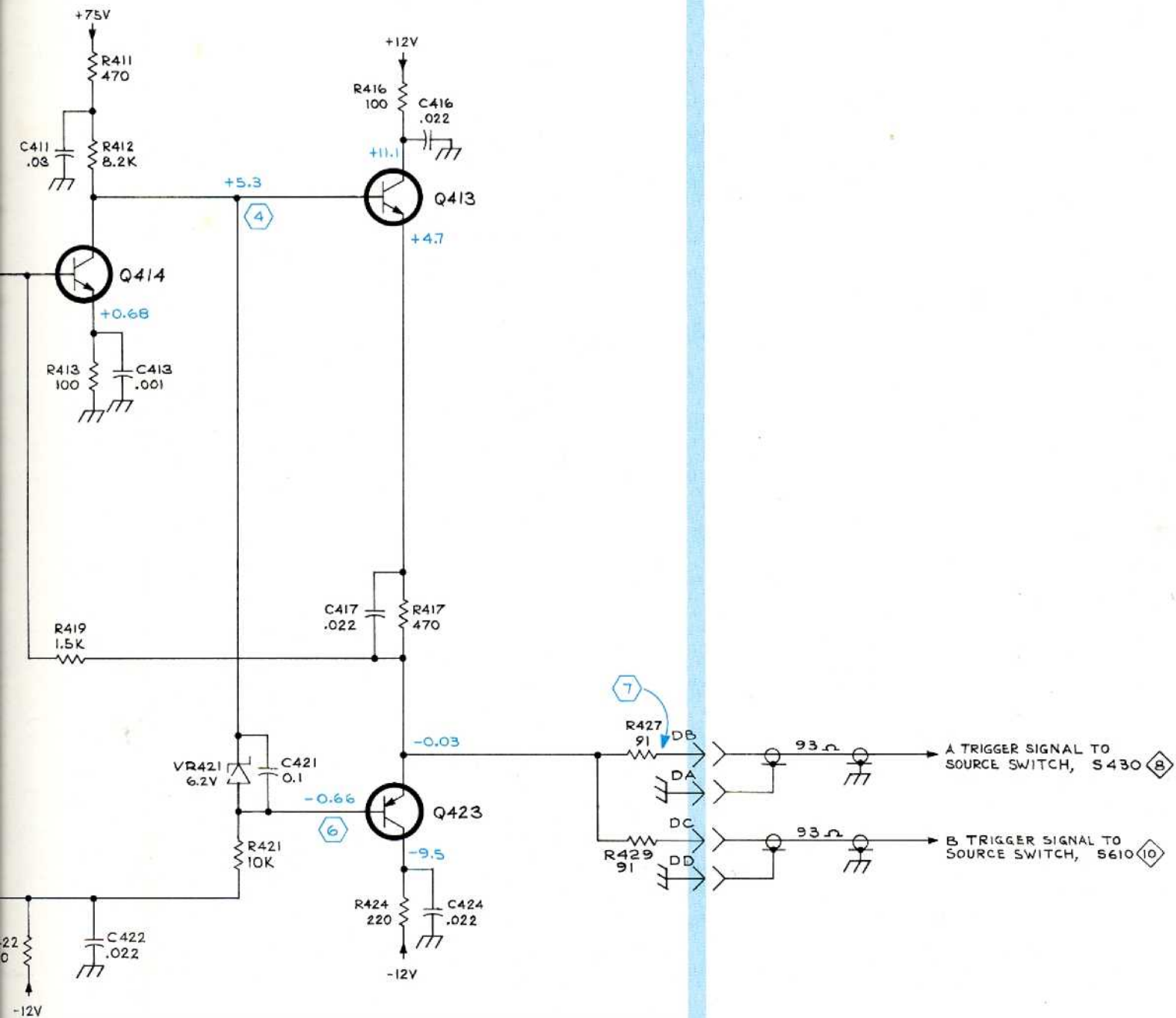
VOLTAGES and WAVEFORMS obtained under conditions given on page 8 2.

- REFERENCE DIAGRAMS**
- 1 CHANNEL 1 INPUT AMPLIFIER
 - 5 VERTICAL SWITCHING
 - 8 A TRIGGER GENERATOR
 - 10 B TRIGGER GENERATOR

SEE PARTS LIST FOR SEMICONDUCTOR TYPES.

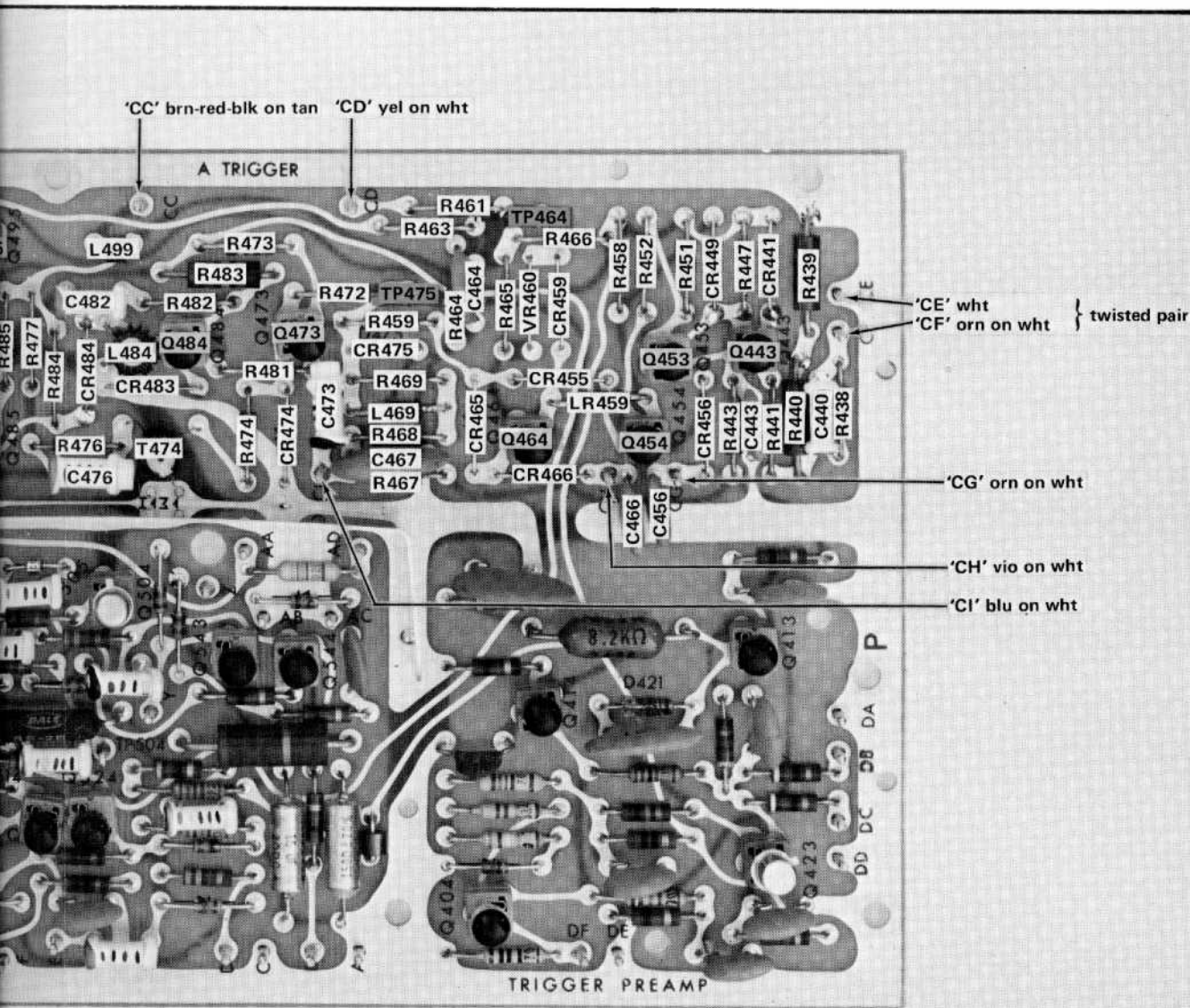


P/O A3 A SWEEP BOARD



(A)

JN
1270
TRIGGER PREAMP 7



N B040000-up

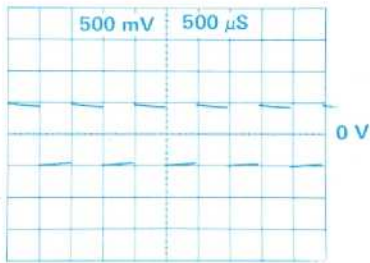


See Figs. 8-5, 8-7 and 8-14 for location of parts not identified here.

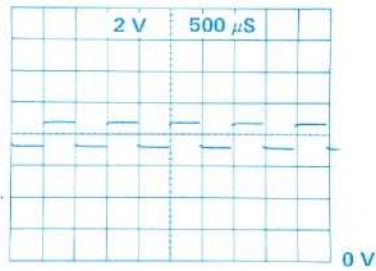


Partial A Sweep circuit board.

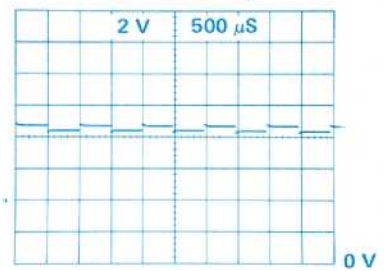
1



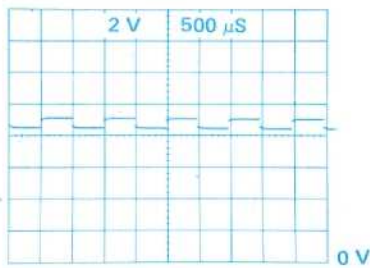
2



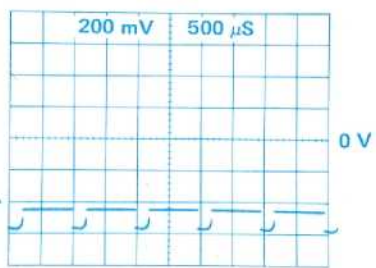
3



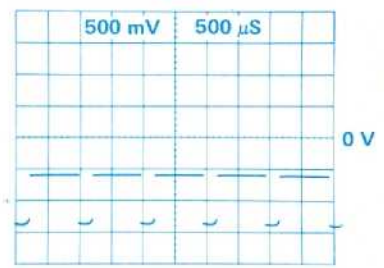
4



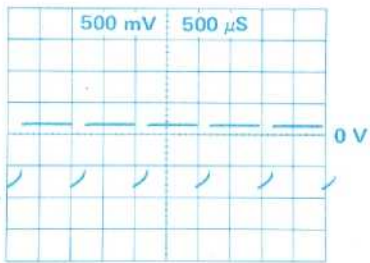
5



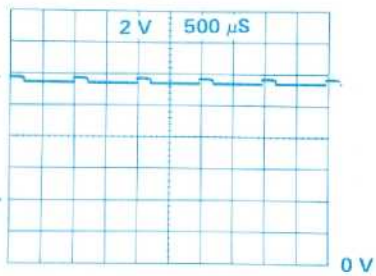
6



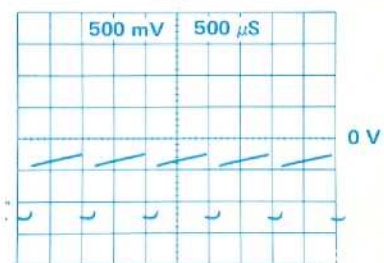
7



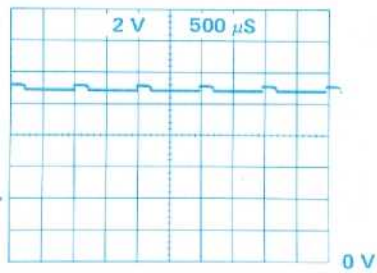
8



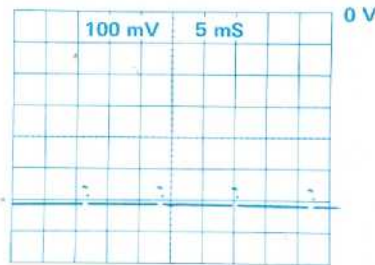
9



10



11

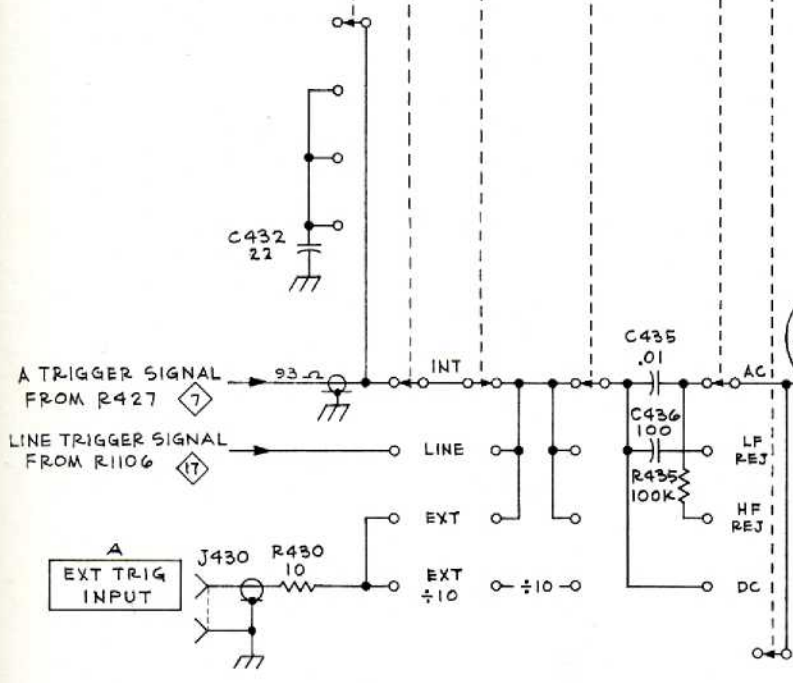


← WAVEFORMS

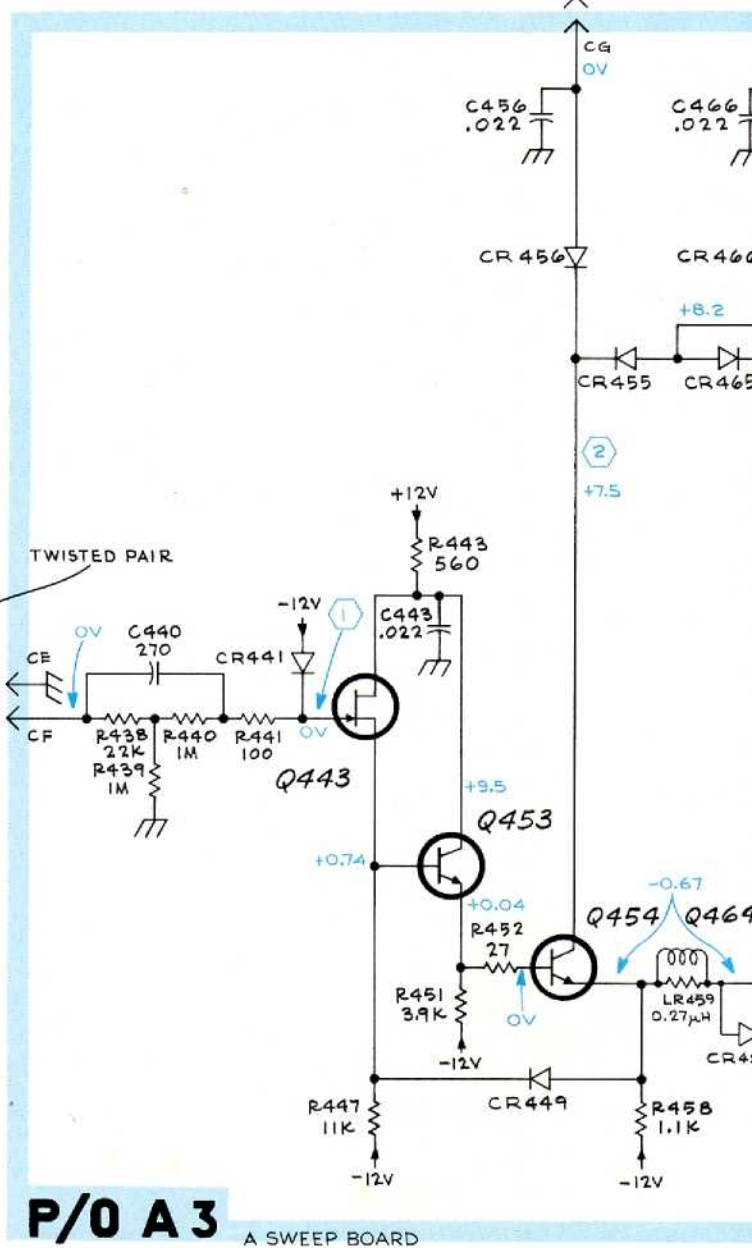
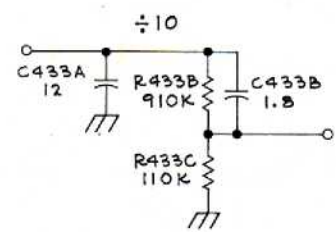
A TRIGGER SOURCE S430

A TRIGGER COUPLING S435

A TRIGGER SLOPE S455



VOLTAGES and WAVEFORMS obtained under conditions given on page 8-2.

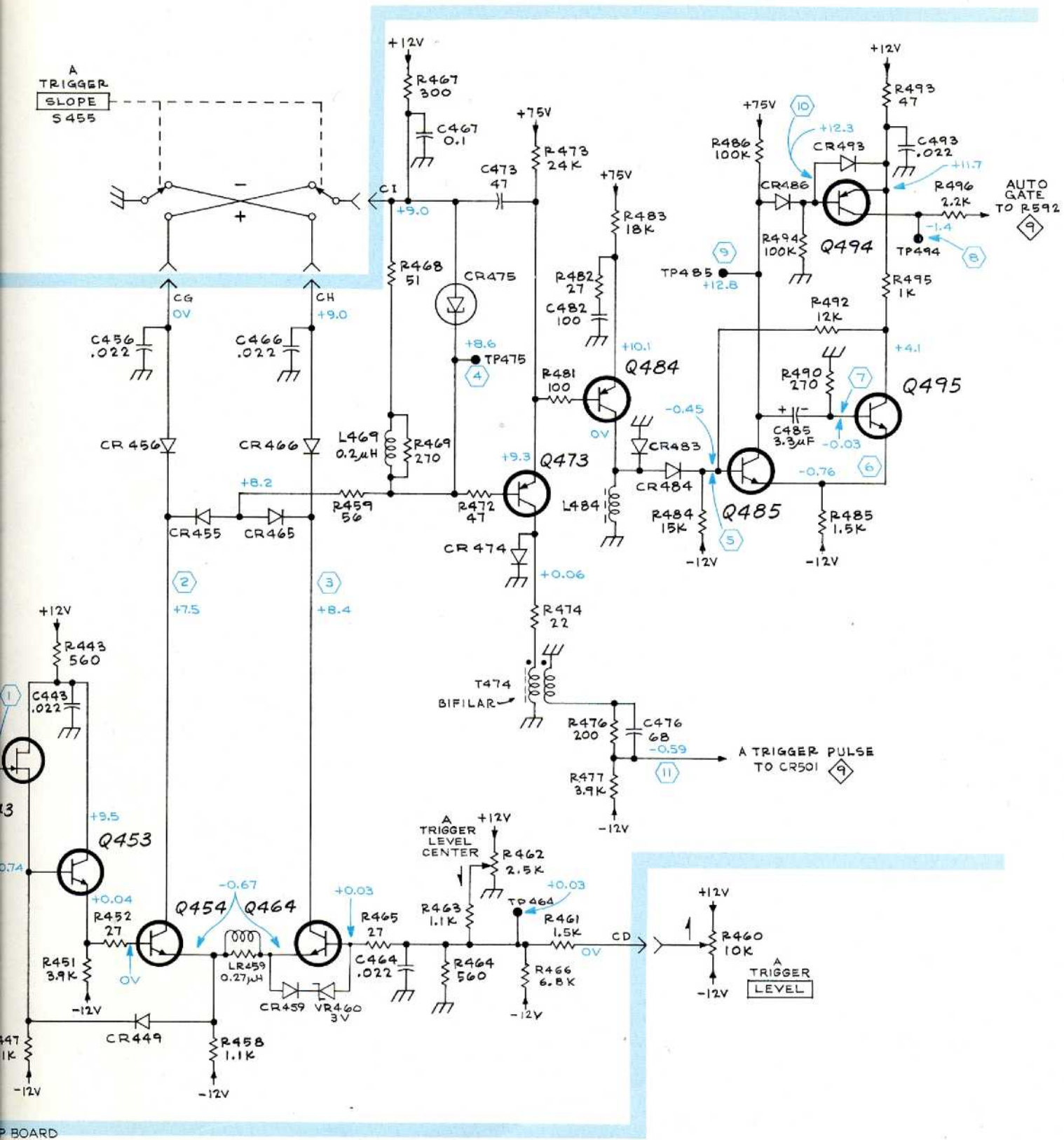


P/O A3

A SWEEP BOARD

REFERENCE DIAGRAMS

- ◇ 7 TRIGGER PREAMP
- ◇ 9 A SWEEP GENERATOR
- ◇ 17 POWER SUPPLY & DISTRIBUTION

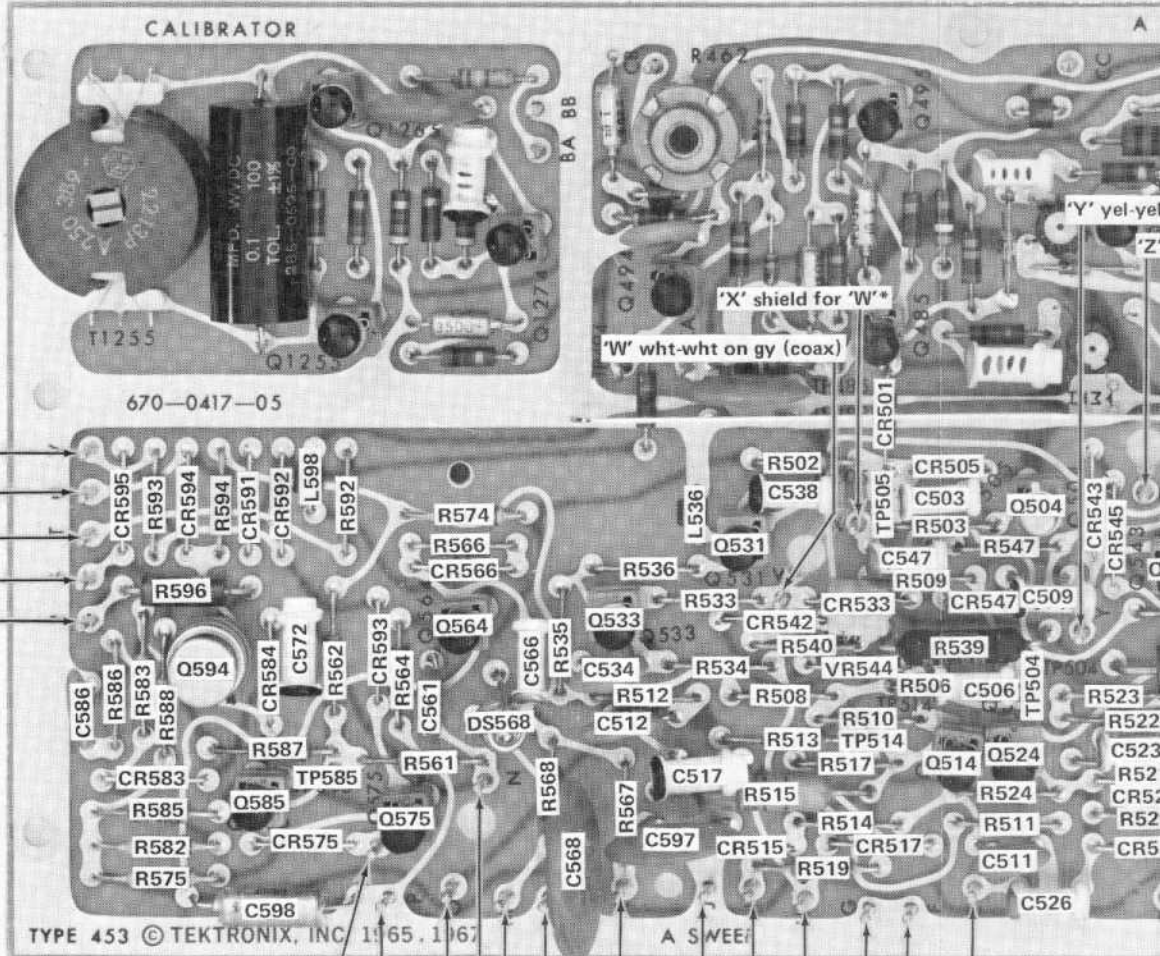


SEE PARTS LIST FOR SEMICONDUCTOR TYPES

P BOARD
RAMS
AMP
GENERATOR
PLY & DISTRIBUTION

A TRIGGER GENERATOR 8

5A5
1270



- 'V' blk-blu on wht
- 'U' blk-red on wht
- 'T' grn on wht
- 'S' brn on wht
- 'R' blk-yel on wht

- 'Q' gy (coax)*
- 'P' shield for 'Q'*
- 'O' blu-grn-blk on wht
- 'N' gy on wht
- 'M' orn-orn on gy (coax)
- 'L' shield for 'M'
- 'K' brn-grn-brn on wht
- 'J' shield for 'I'
- 'I' grn-grn on gy (coax)
- 'H' red-red on gy (coax)
- 'G' shield for 'H'
- 'F' shield for 'E'
- 'E' wht-wht on gy (coax)

*Wires connected through hole in board

See Figs. 8-5, 8-6 and 8-14 for location of parts not identified here.

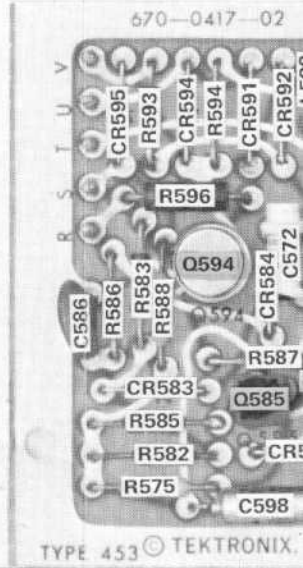
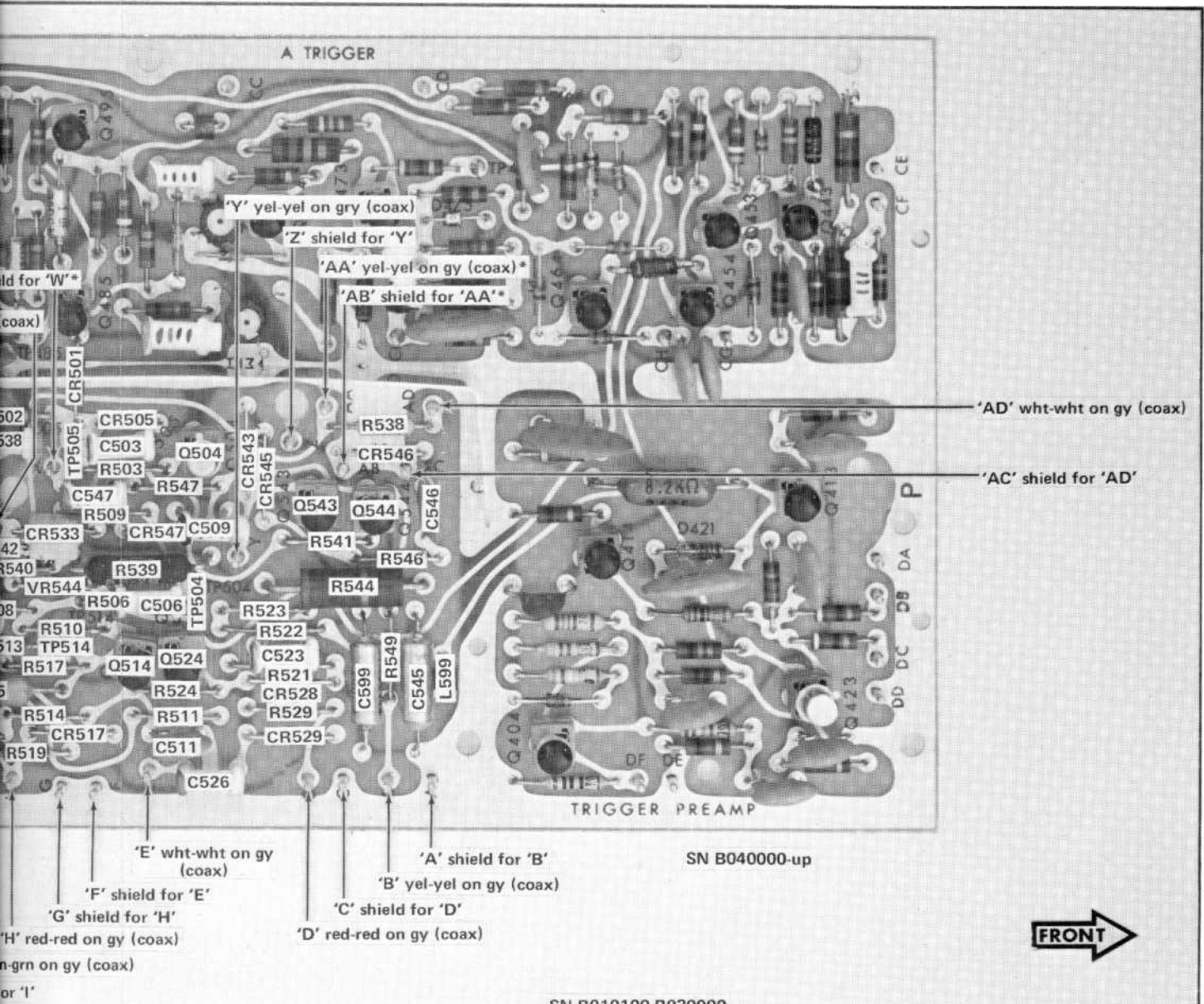
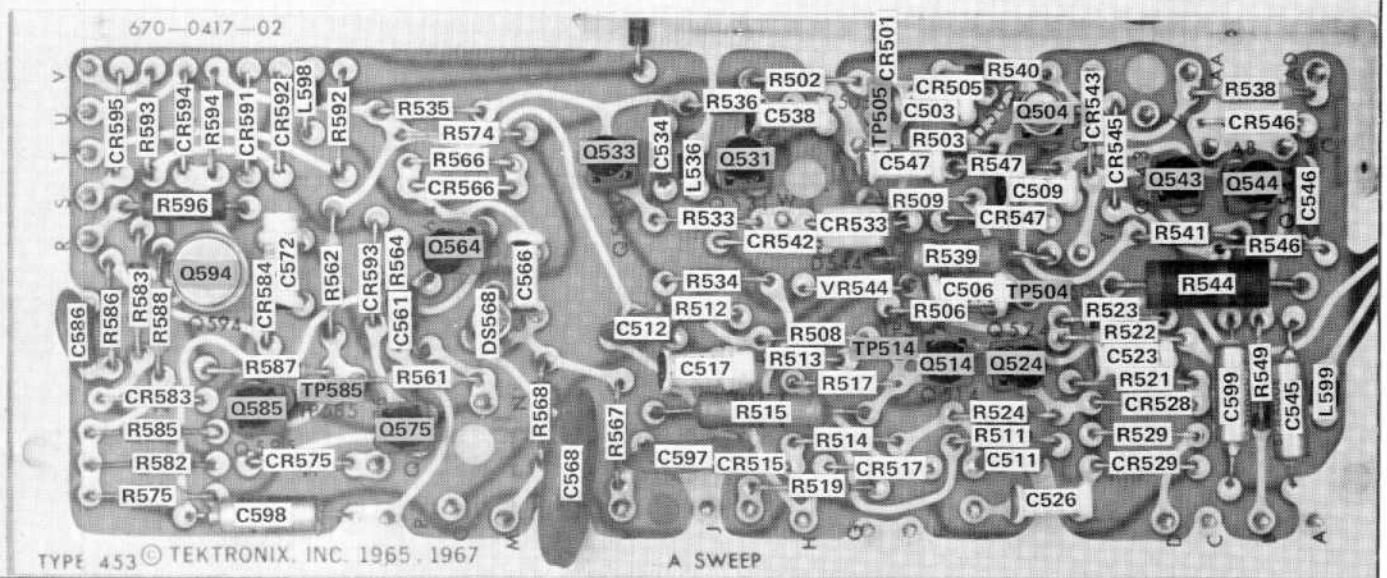


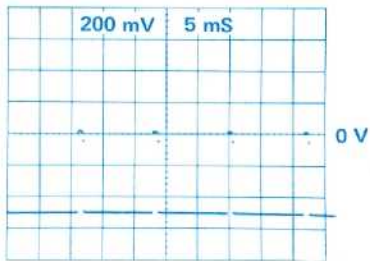
Fig. 8-7. P/O A3. Partial A Sweep circuit board



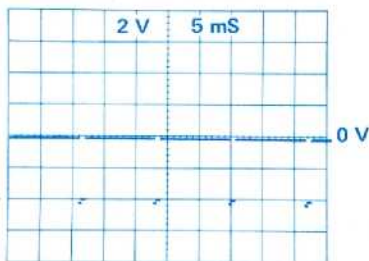
SN B010100-B039999



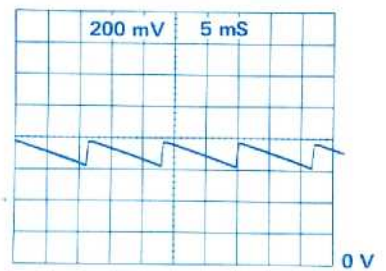
1



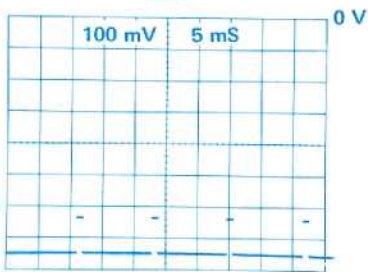
2



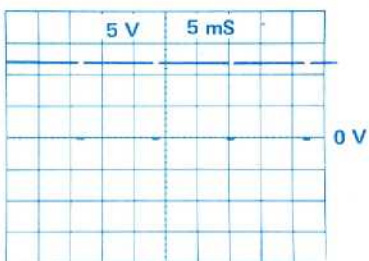
3



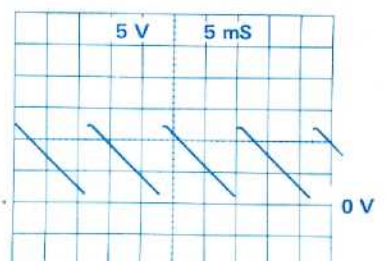
4



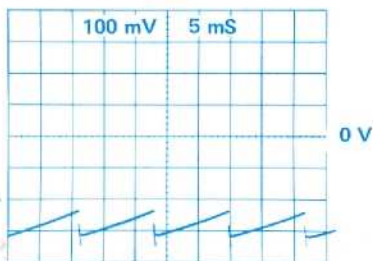
5



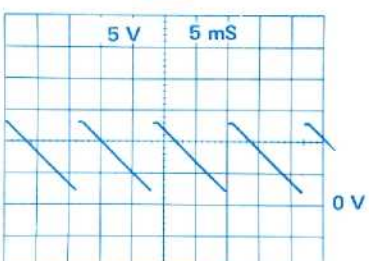
6



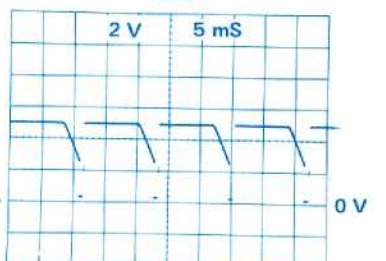
7



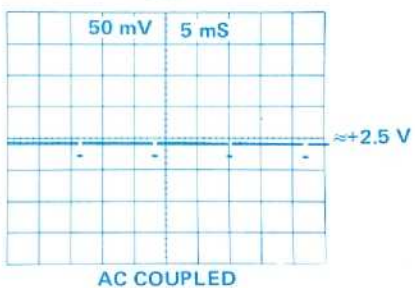
8



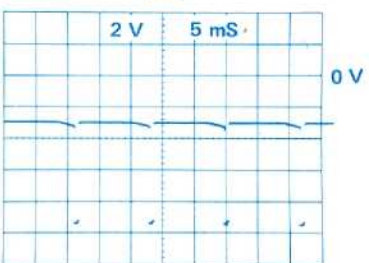
9



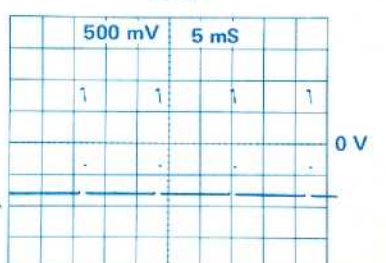
10

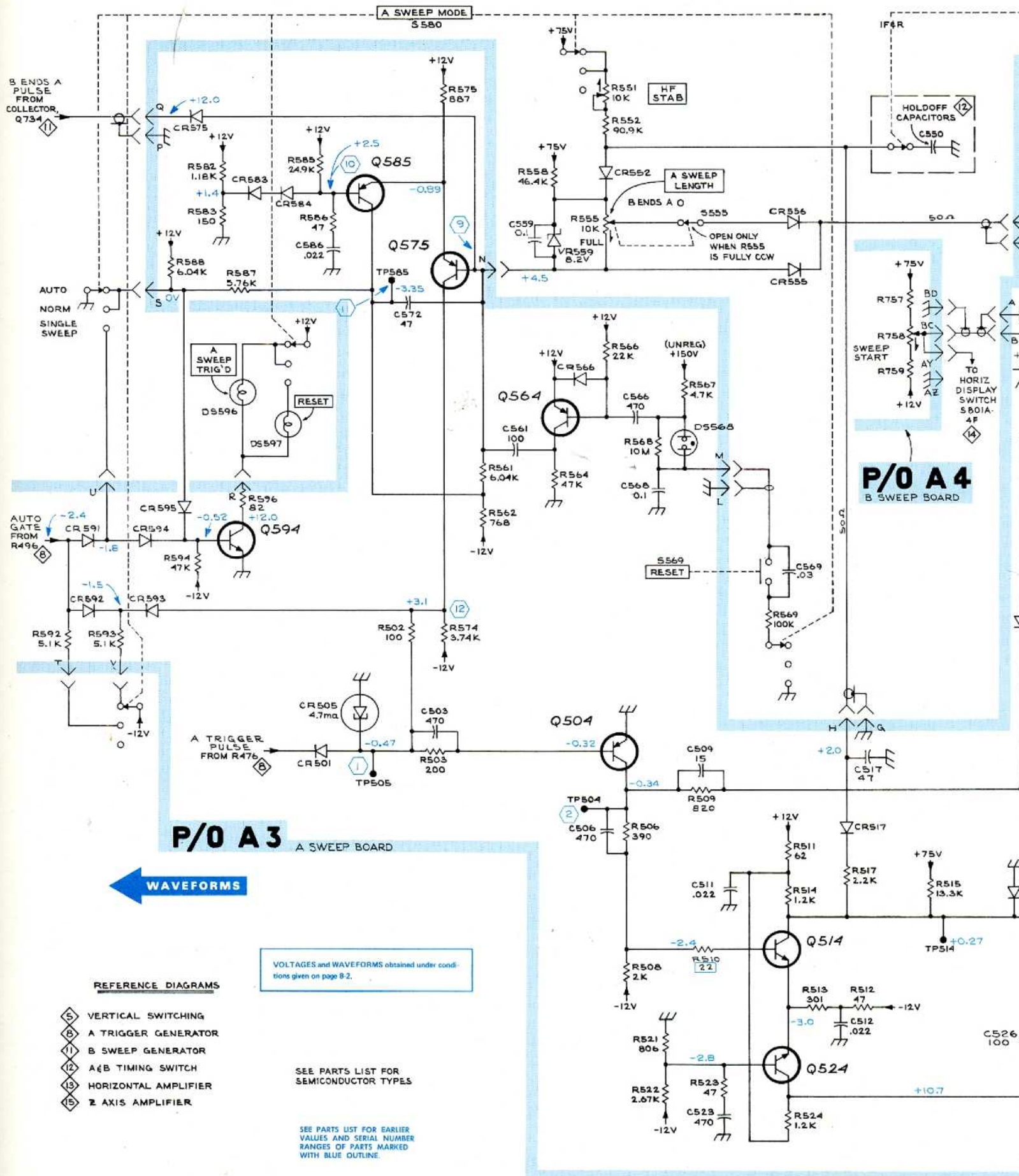


11



12





P/O A3
A SWEEP BOARD

P/O A4
B SWEEP BOARD

B ENDS A PULSE FROM COLLECTOR, Q734

AUTO NORM SINGLE SWEEP

AUTO GATE FROM R496

A TRIGGER PULSE FROM R476

← WAVEFORMS

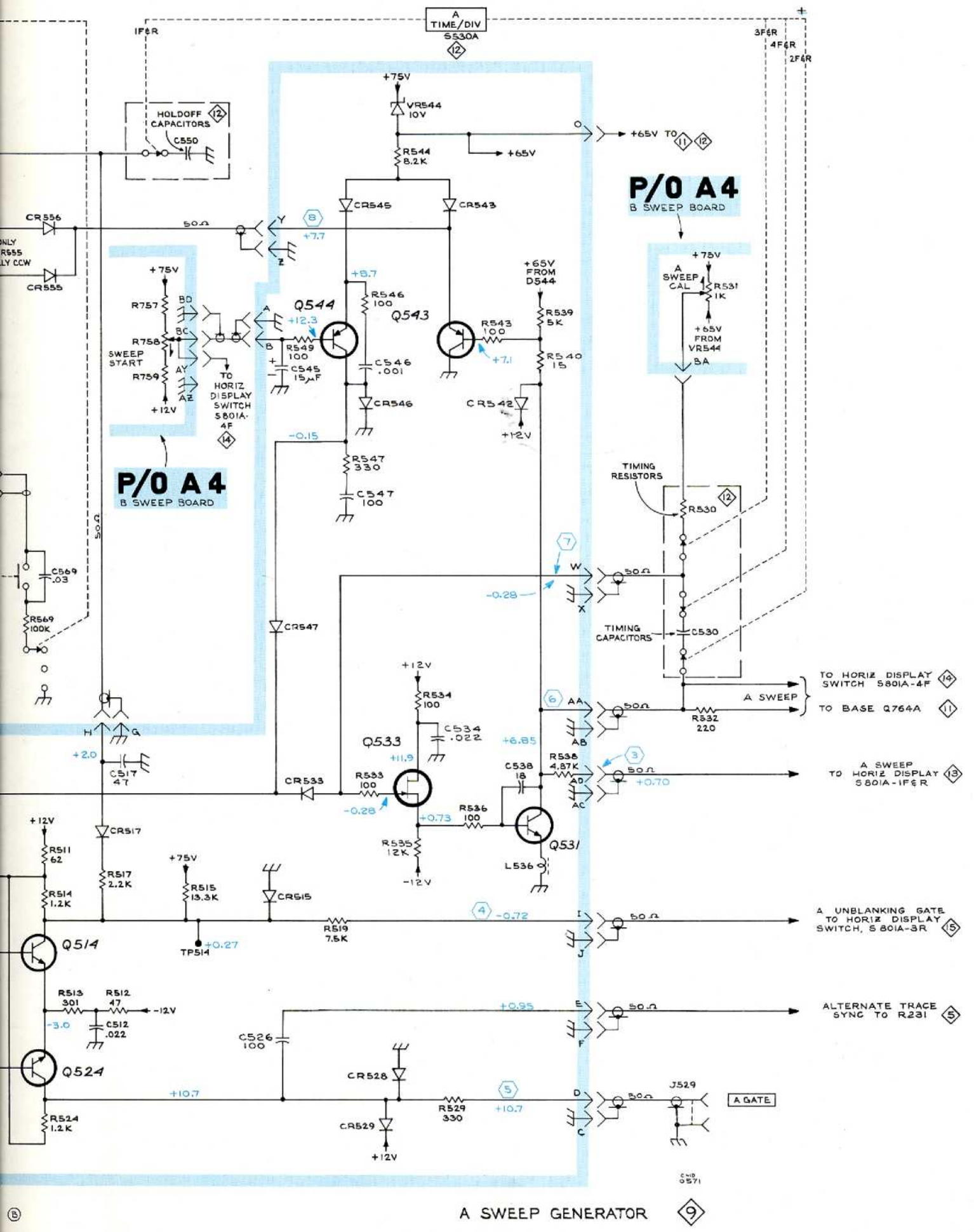
VOLTAGES and WAVEFORMS obtained under conditions given on page 9-2.

REFERENCE DIAGRAMS

- 8 VERTICAL SWITCHING
- 11 A TRIGGER GENERATOR
- 12 B SWEEP GENERATOR
- 13 A-B TIMING SWITCH
- 15 HORIZONTAL AMPLIFIER
- 15 Z AXIS AMPLIFIER

SEE PARTS LIST FOR SEMICONDUCTOR TYPES

SEE PARTS LIST FOR EARLIER VALUES AND SERIAL NUMBER RANGES OF PARTS MARKED WITH BLUE OUTLINE.



A SWEEP GENERATOR

P/O A4
B SWEEP BOARD

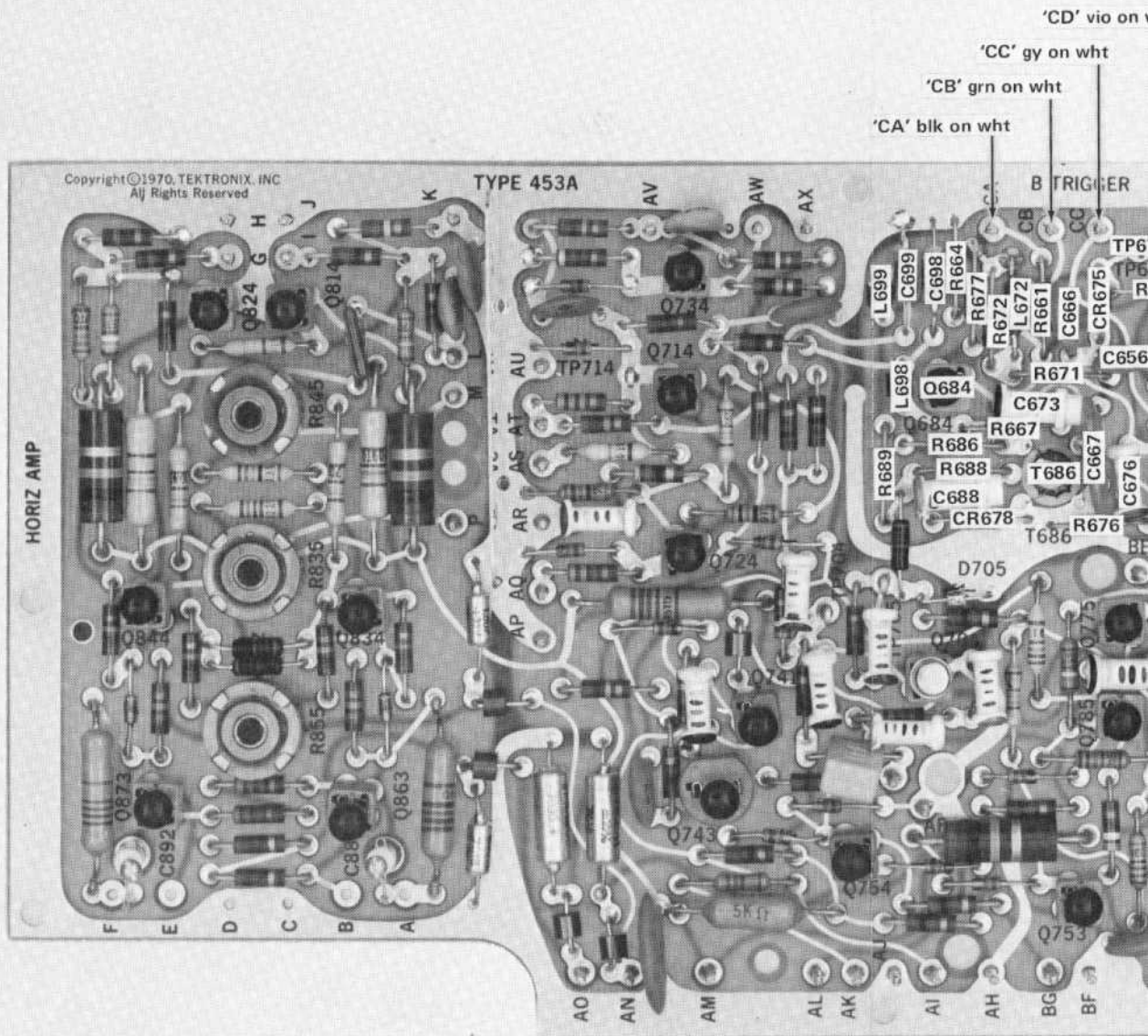
P/O A4
B SWEEP BOARD

- TO HORIZ DISPLAY SWITCH 5801A-4F
- TO BASE Q764A
- TO A SWEEP TO HORIZ DISPLAY 5801A-1F&R
- A UNBLANKING GATE TO HORIZ DISPLAY SWITCH, 5801A-3R
- ALTERNATE TRACE SYNC TO R231

A GATE

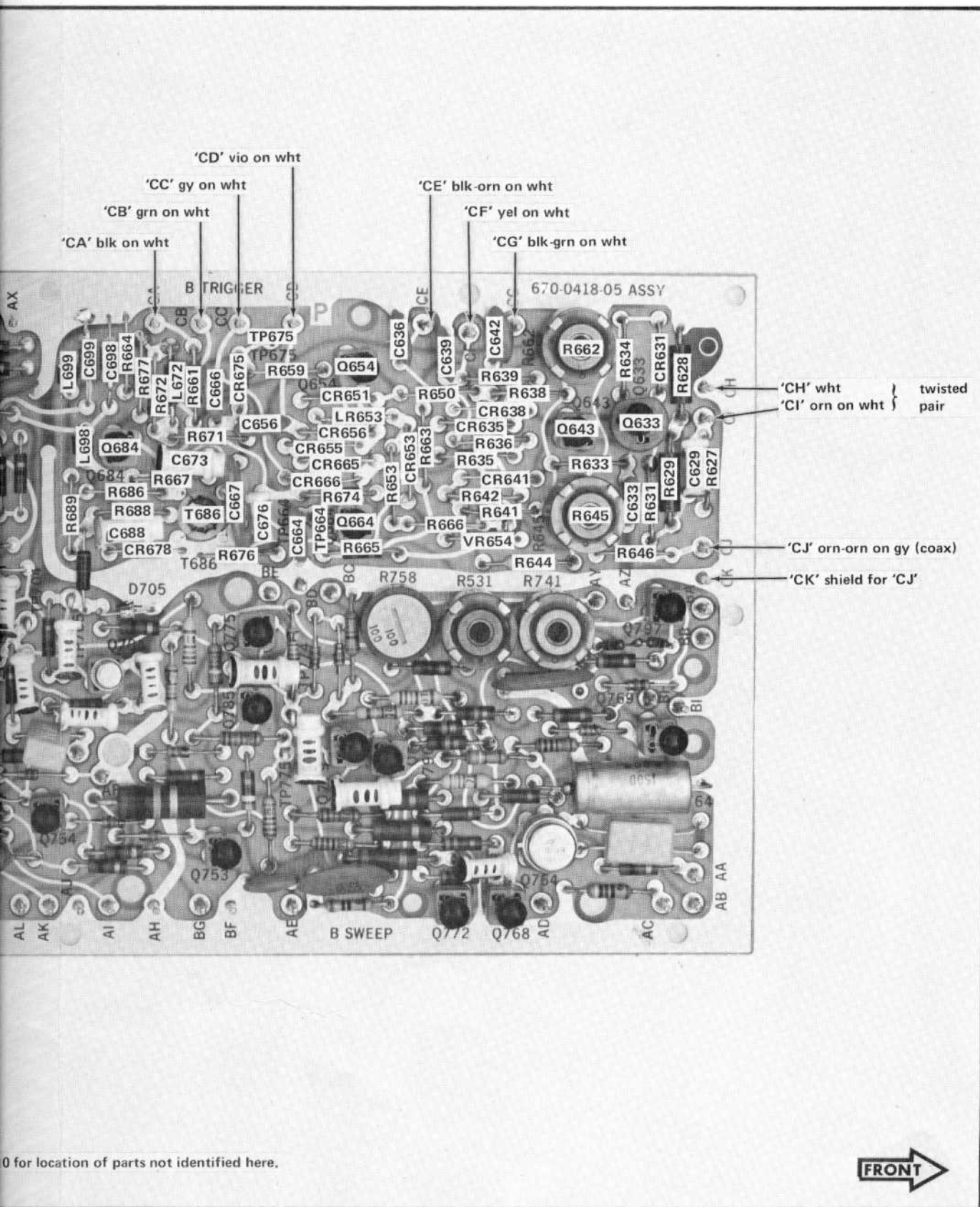
9

8



See Figs. 8-9 and 8-10 for location of parts not identified here.

Fig. 8-8. P/O A4. Partial B Sweep circuit board.

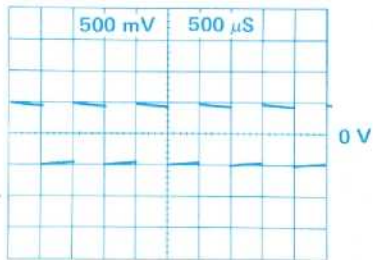


0 for location of parts not identified here.

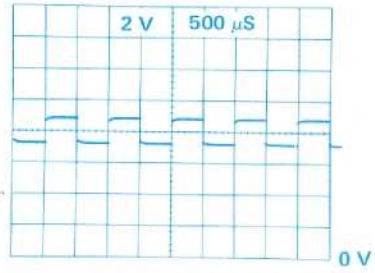


A4. Partial B Sweep circuit board.

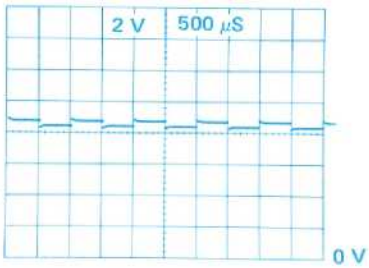
1



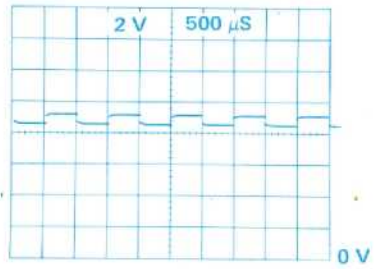
2



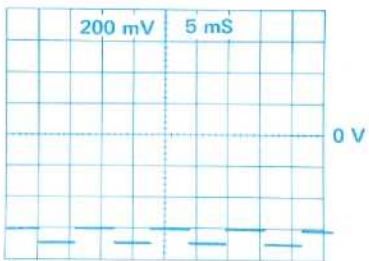
3



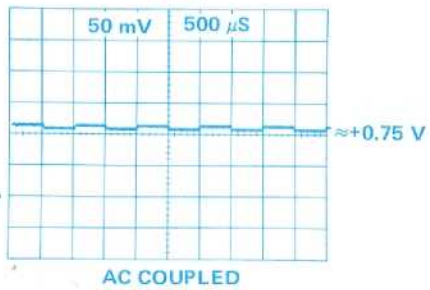
4



5

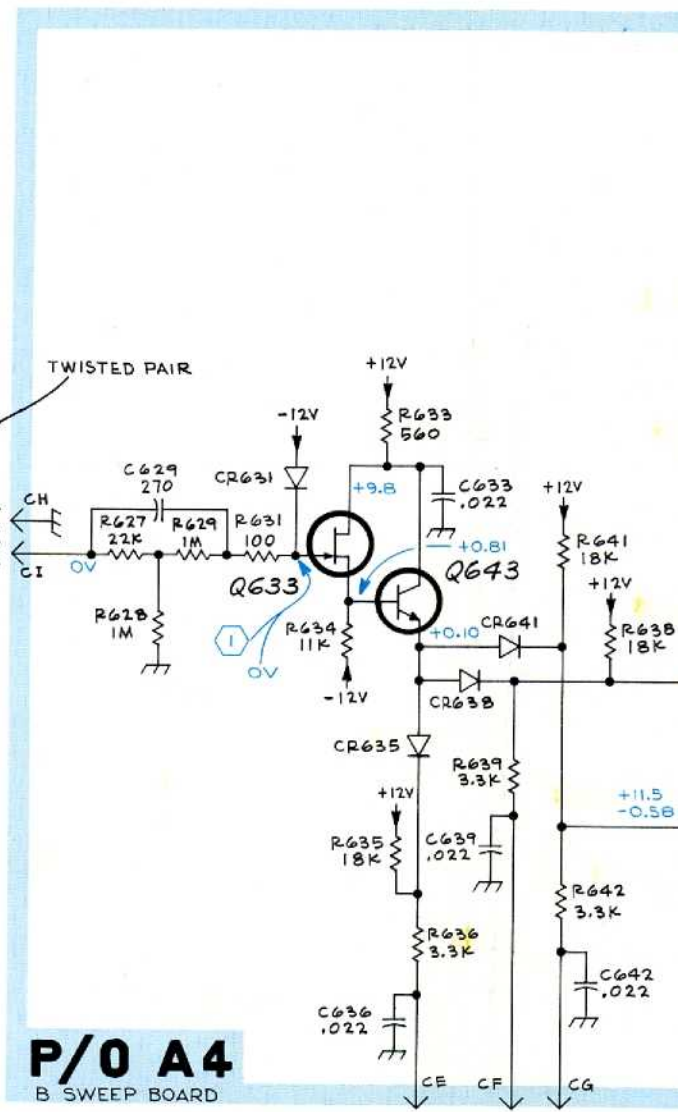
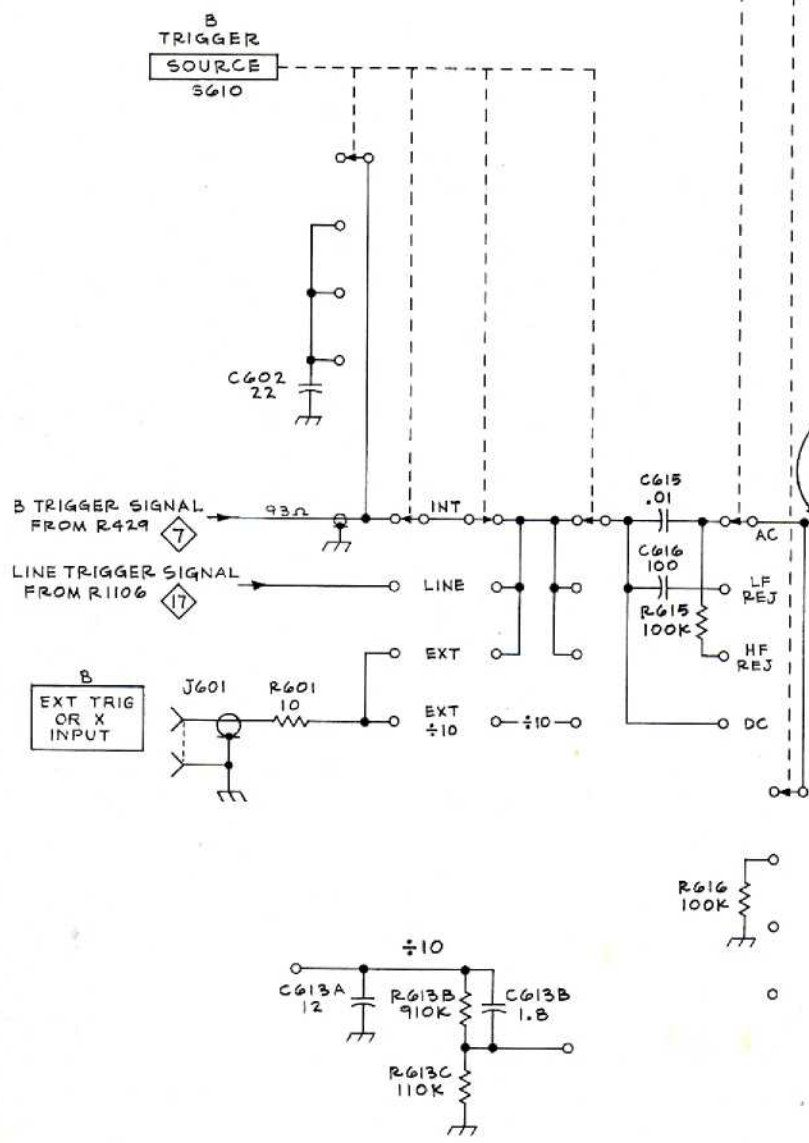


6*



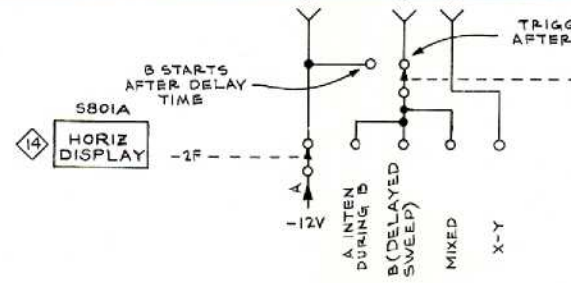
← WAVEFORMS

B
TRIGGER
COUPLING
5615



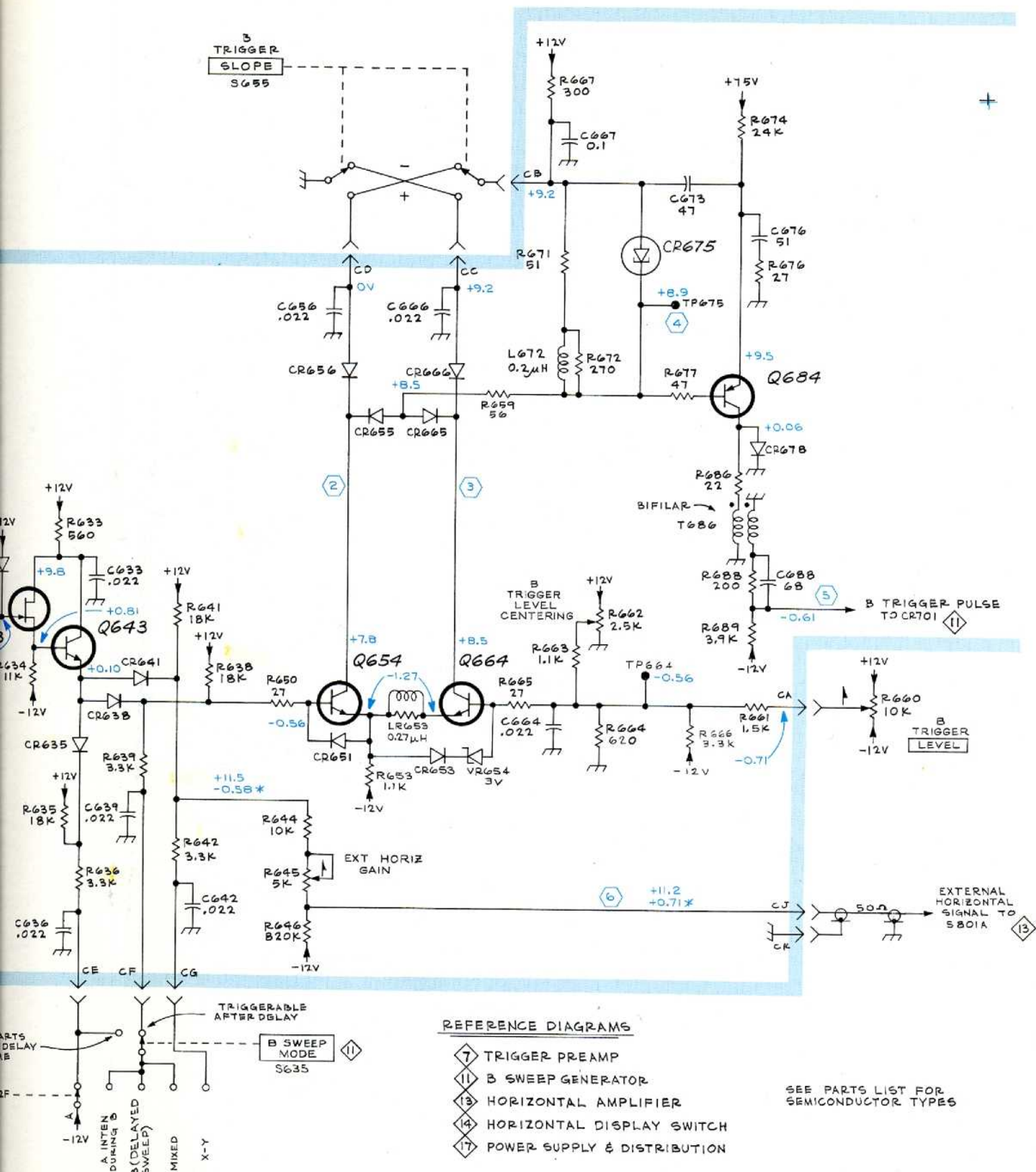
VOLTAGES and WAVEFORMS obtained under conditions given on page B-2 except as follows:

HORIZ DISPLAY	B (DELAYED SWEEP)
*HORIZ DISPLAY	X-Y



+

(A)



REFERENCE DIAGRAMS

- 7 TRIGGER PREAMP
- 11 B SWEEP GENERATOR
- 13 HORIZONTAL AMPLIFIER
- 4 HORIZONTAL DISPLAY SWITCH
- 7 POWER SUPPLY & DISTRIBUTION

SEE PARTS LIST FOR SEMICONDUCTOR TYPES

B TRIGGER GENERATOR 10

GAR 1270

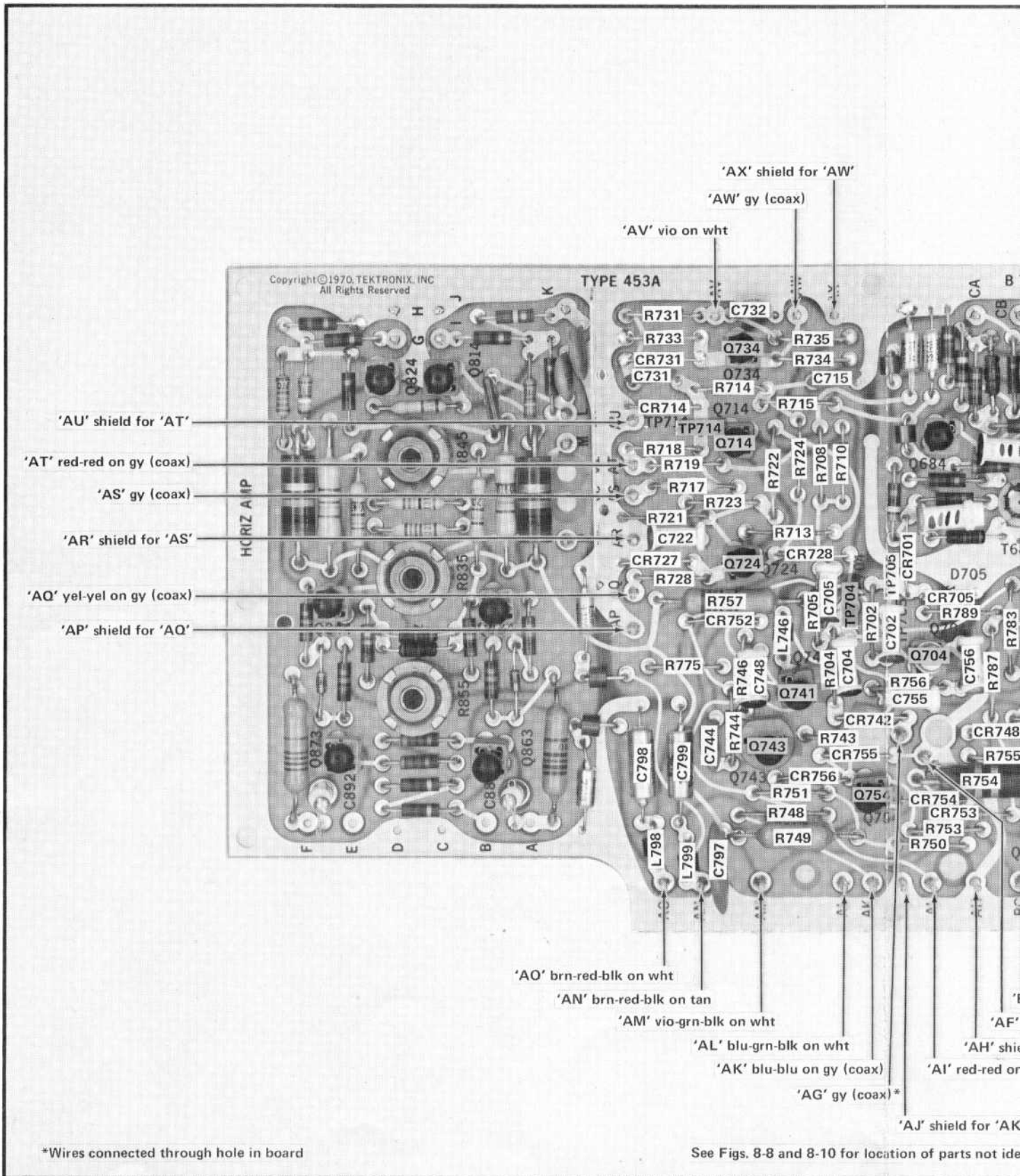
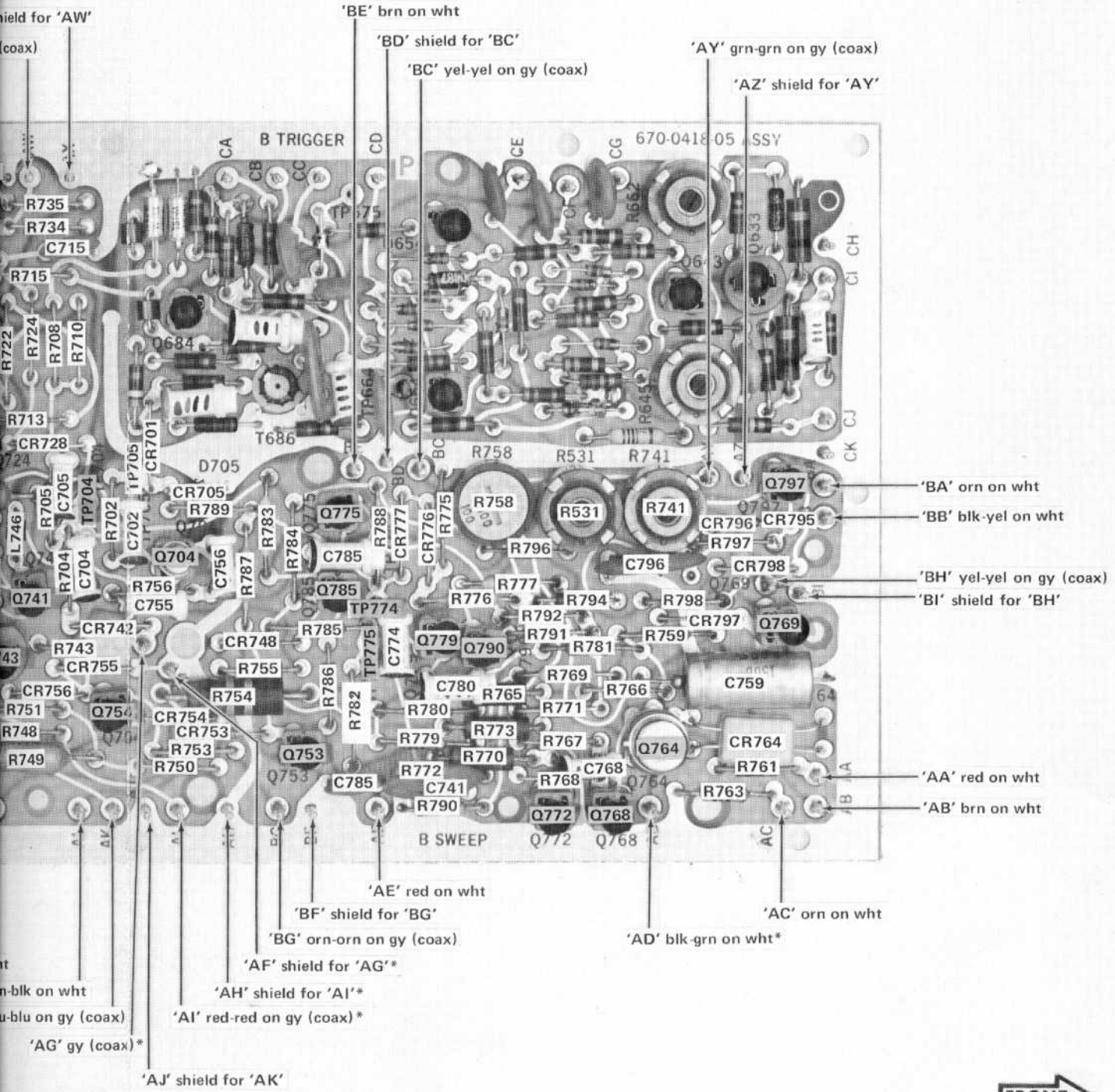


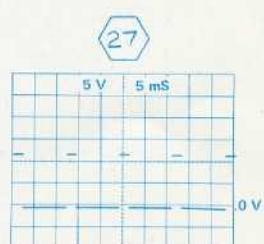
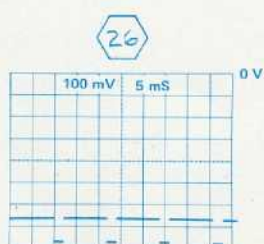
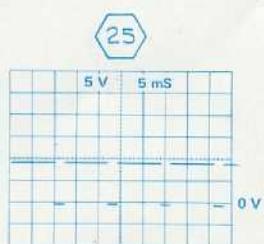
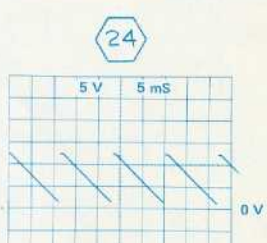
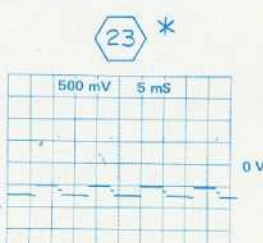
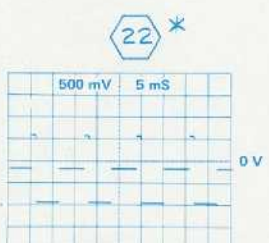
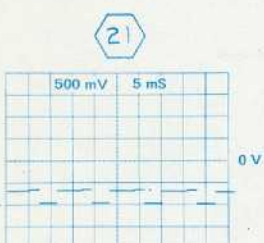
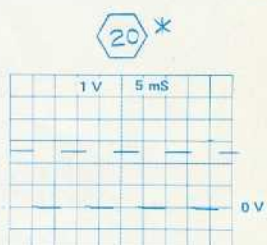
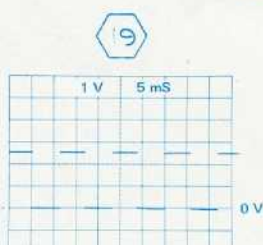
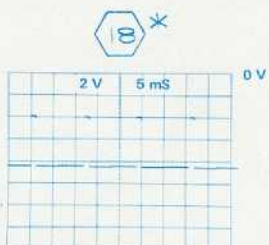
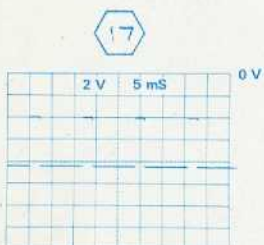
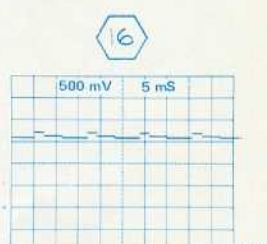
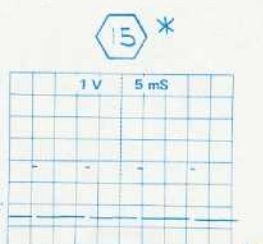
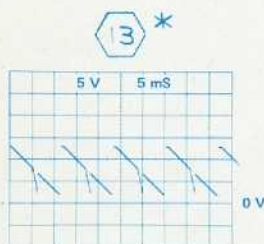
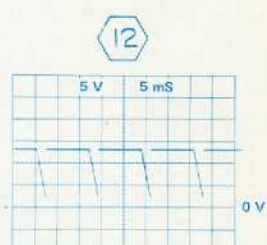
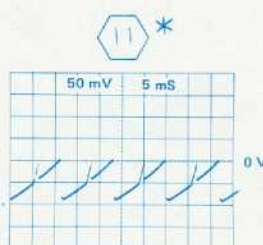
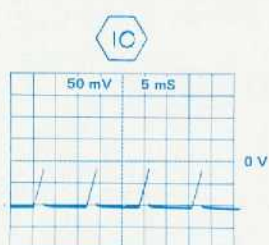
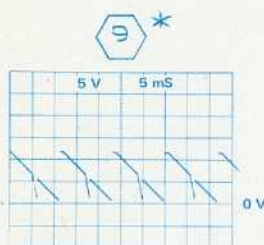
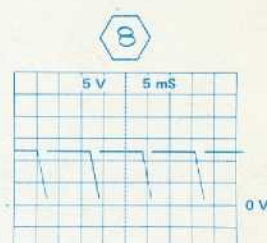
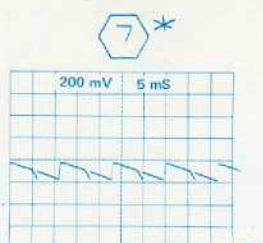
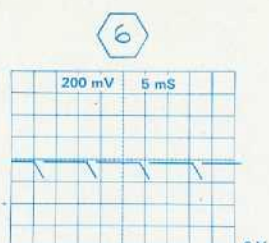
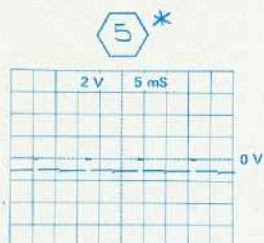
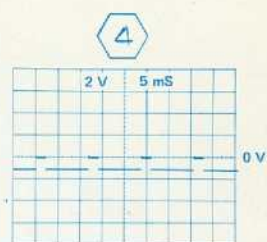
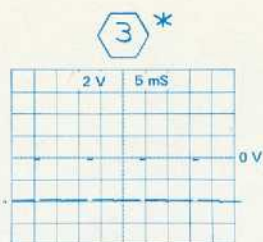
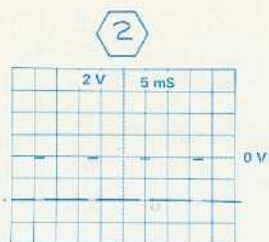
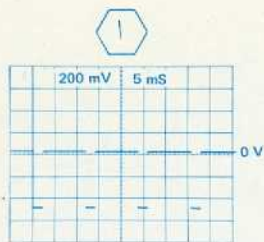
Fig. 8-9. P/O A4. Partial B Sweep circuit b

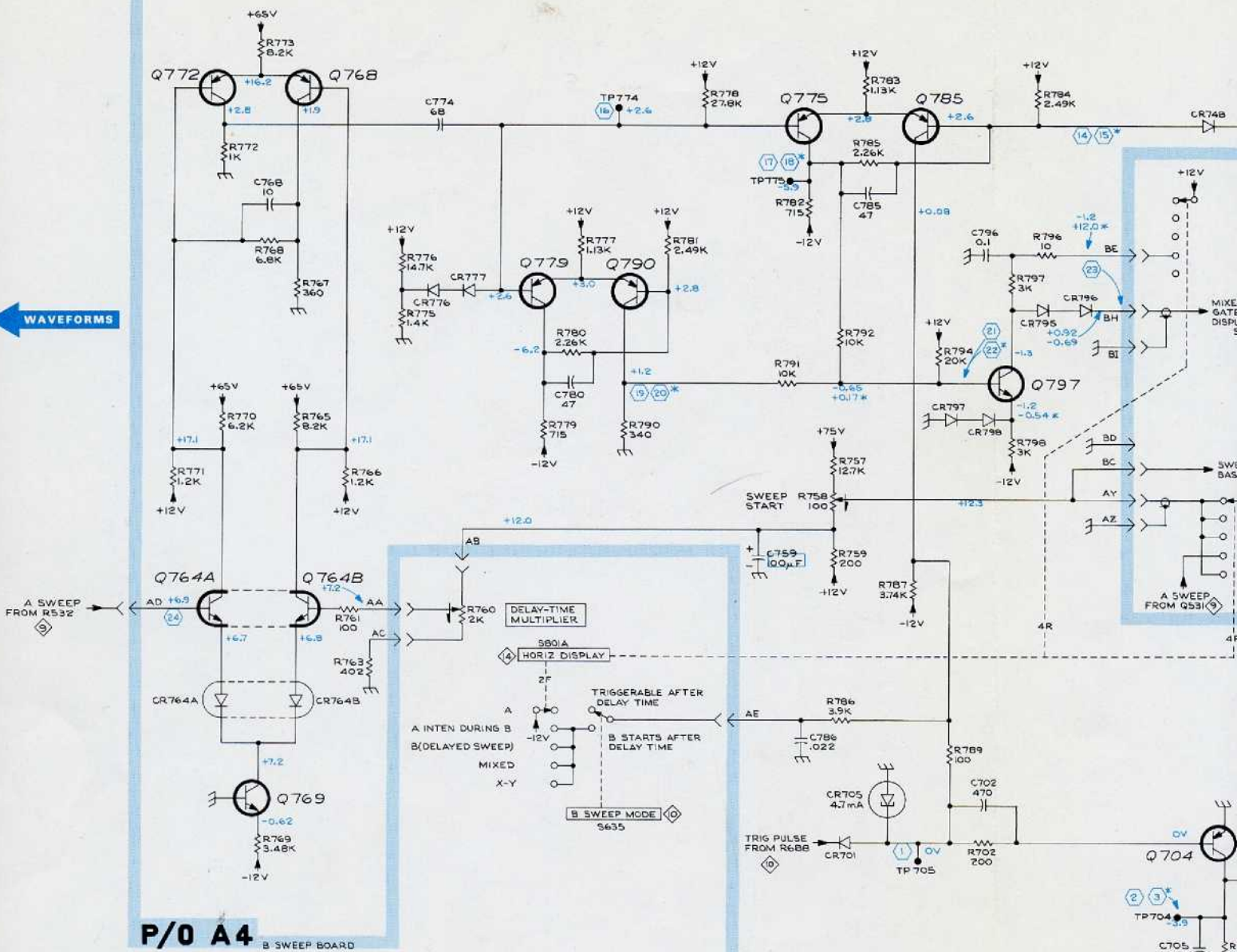


8 and 8-10 for location of parts not identified here.



8-9. P/O A4. Partial B Sweep circuit board.





P/O A4
B SWEEP BOARD

REFERENCE DIAGRAMS

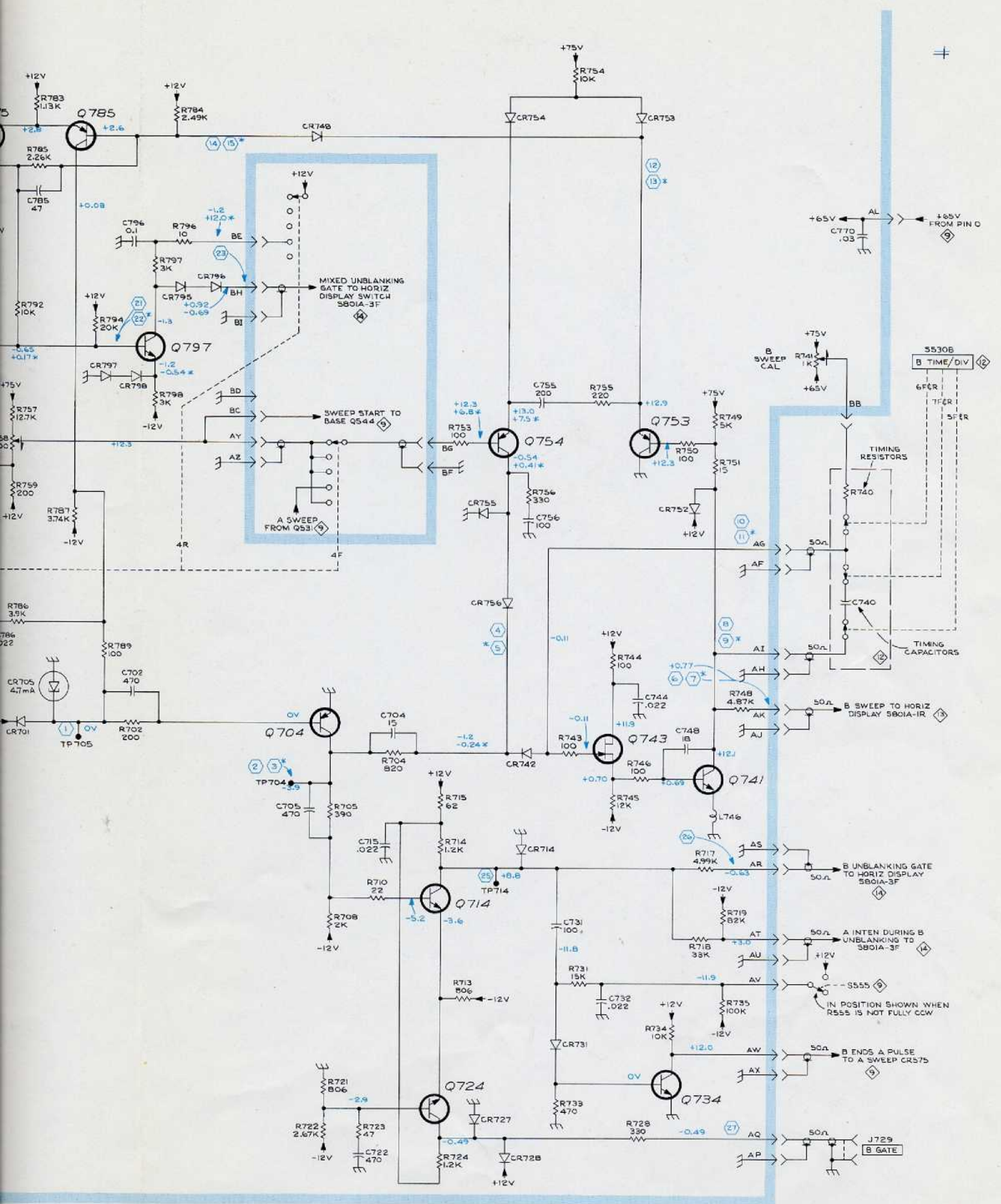
- ① A SWEEP GENERATOR
- ② B TRIGGER GENERATOR
- ③ A & B TIMING SWITCH
- ④ HORIZONTAL AMPLIFIER
- ⑤ HORIZONTAL DISPLAY SWITCH
- ⑥ Z AXIS AMPLIFIER

VOLTAGES and WAVEFORMS obtained under load.
 (See plots on page B-2 except as follows):

HORIZ DISPLAY	B (DELAYED SWEEP)
"HORIZ DISPLAY	MIXED

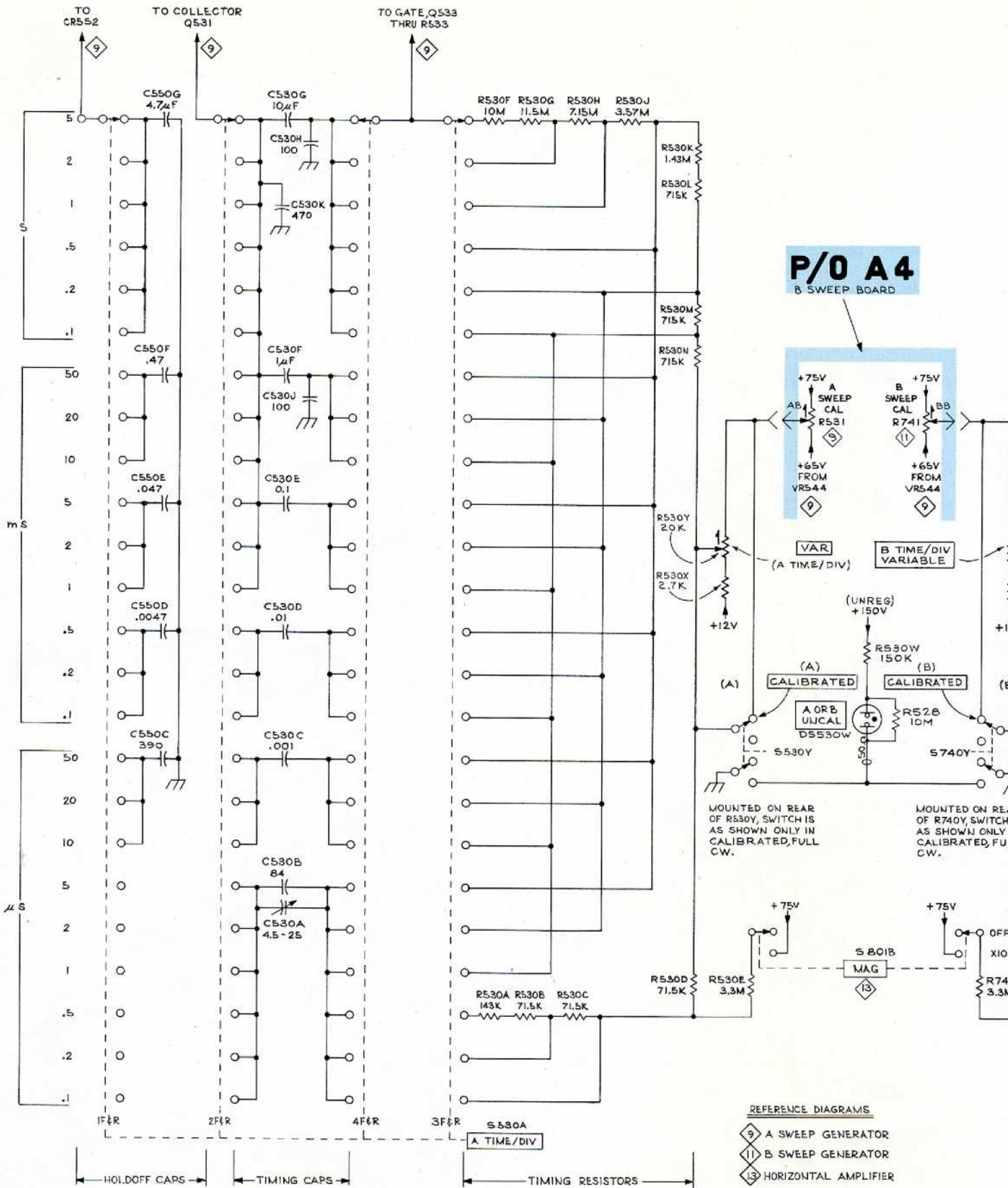
SEE PARTS LIST FOR EARLIER
 VALUES AND SERIAL NUMBERS.
 RANGES OF PARTS MARKED
 WITH BLUE OUTLINE.

SEE PARTS LIST FOR
 SEMICONDUCTOR TYPES

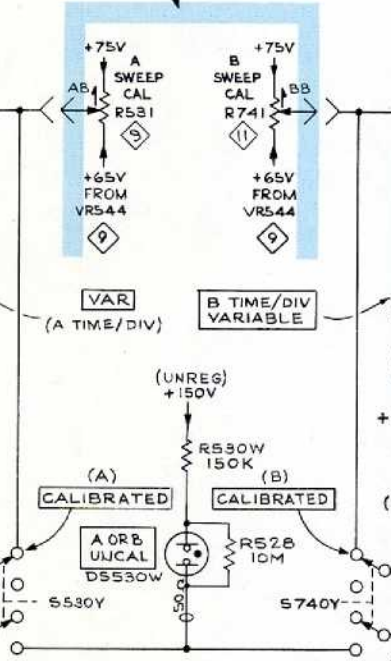


B SWEEP GENERATOR (11)

685
1071



P/O A4 B SWEEP BOARD



REFERENCE DIAGRAMS

- ⑨ A SWEEP GENERATOR
- ⑪ B SWEEP GENERATOR
- ⑬ HORIZONTAL AMPLIFIER

453A OSCILLOSCOPE

R530F 11.5M
R530G 7.15M
R530H 3.57M

R530K 1.43M
R530L 715K

R530M 715K
R530N 715K

R530Y 20K
R530X 2.7K

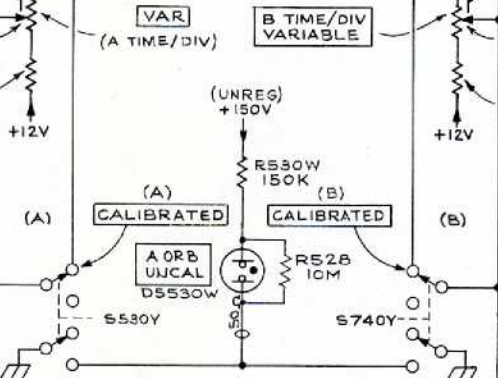
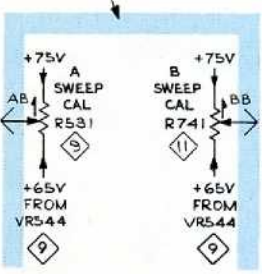
R530D 71.5K
R530E 3.3M

R530A 3K
R530B 71.5K
R530C 71.5K

R530A
TIME/DIV

P/O A4

B SWEEP BOARD



MOUNTED ON REAR OF R530Y, SWITCH IS AS SHOWN ONLY IN CALIBRATED, FULL CW.

MOUNTED ON REAR OF R740Y, SWITCH IS AS SHOWN ONLY IN CALIBRATED, FULL CW.

REFERENCE DIAGRAMS

- 9 A SWEEP GENERATOR
- 11 B SWEEP GENERATOR
- 13 HORIZONTAL AMPLIFIER

TIMING RESISTORS

TIMING RESISTORS

TIMING CAPS

TO GATE, Q743 THRU R743

TO COLLECTOR Q741

R740J 3.57M
R740K 1.43M
R740L 715K

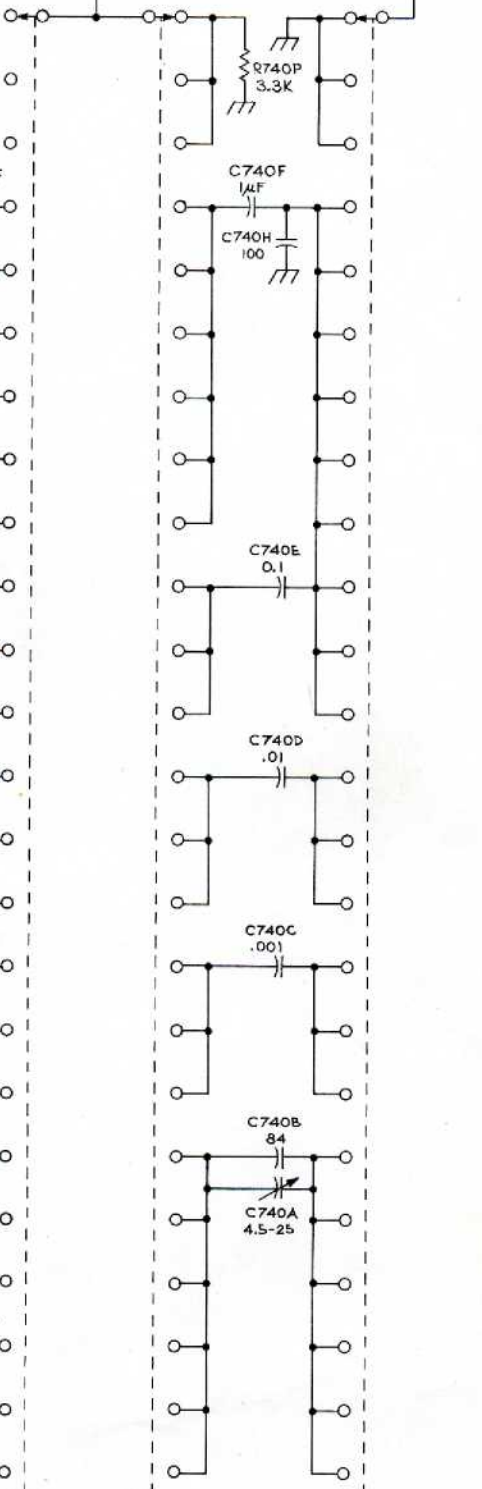
R740M 715K
R740N 715K

R740Y 20K
R740X 2.7K

R740E 3.3M
R740D 71.5K

R740C 71.5K
R740B 71.5K
R740A 143K

R550B
B TIME/DIV



A AND B TIMING SWITCH

JN 1270

(A)

(12)

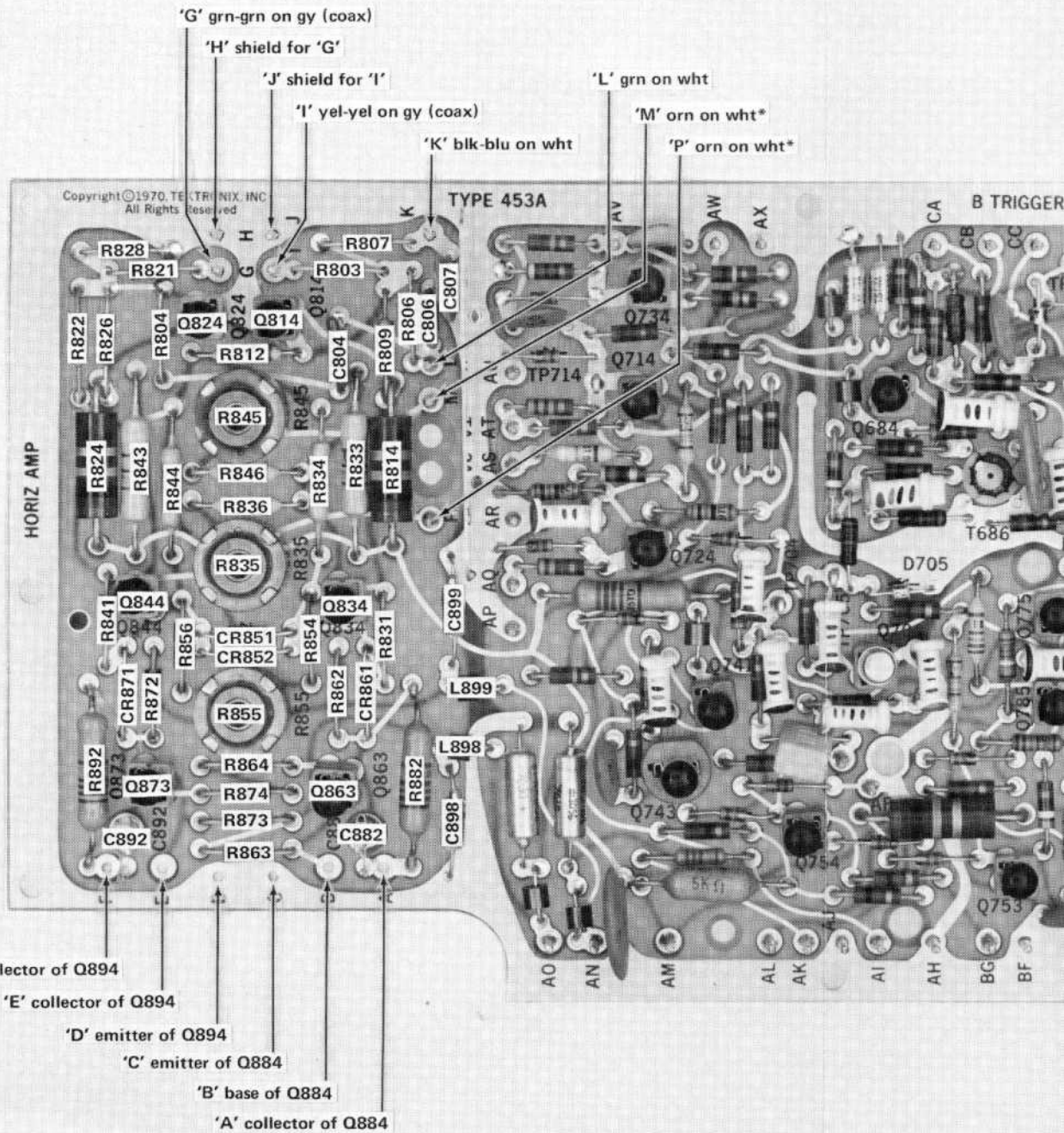
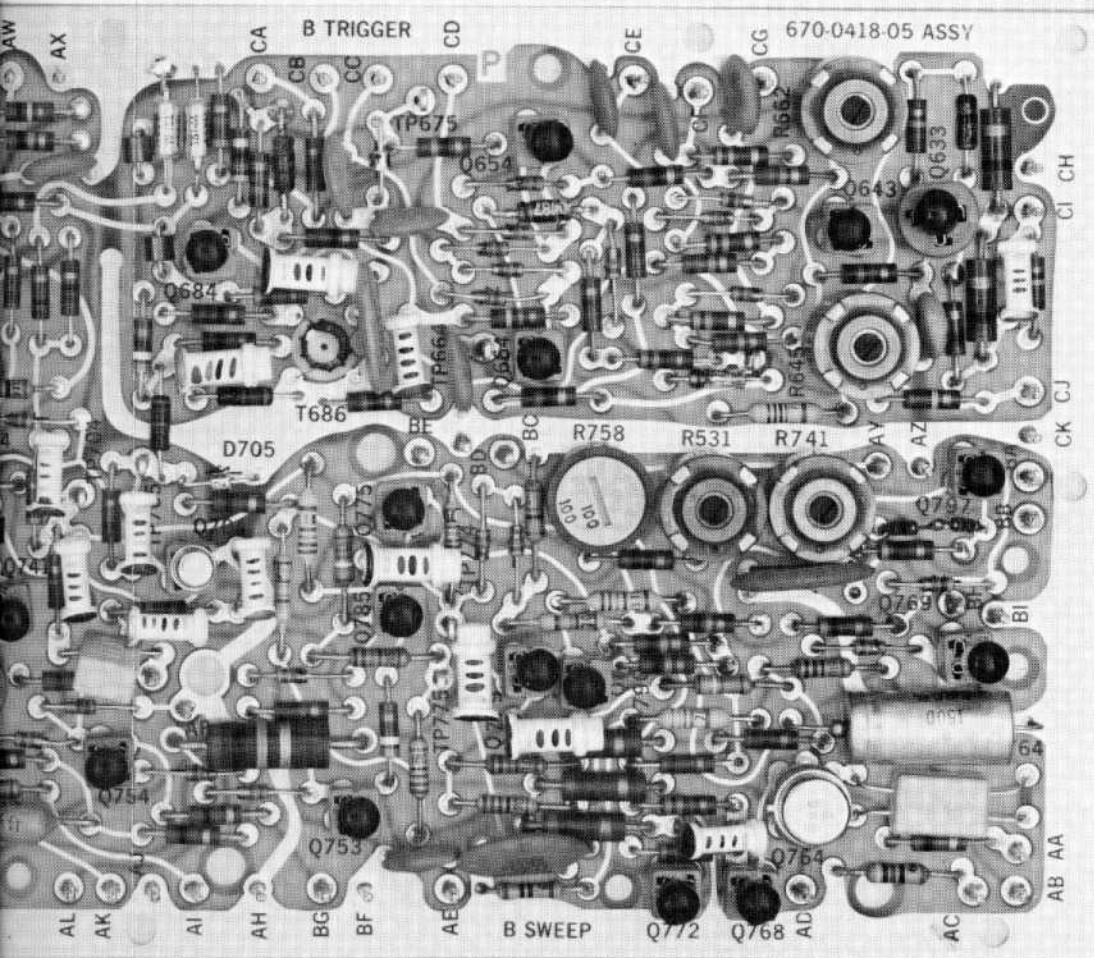


Fig. 8-10. P/O A4. Partial B Sweep circuit board.

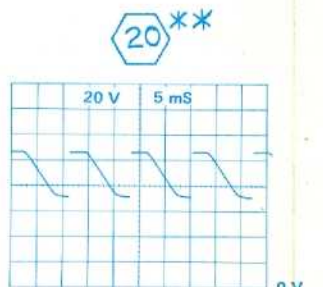
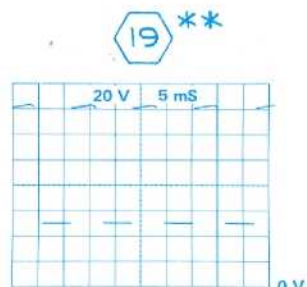
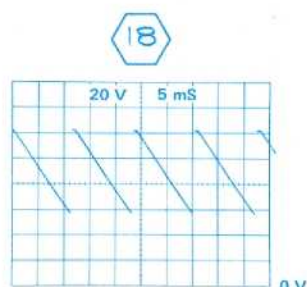
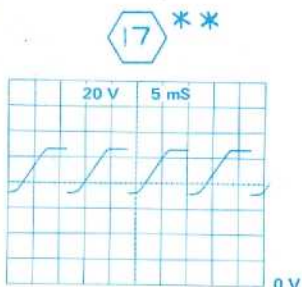
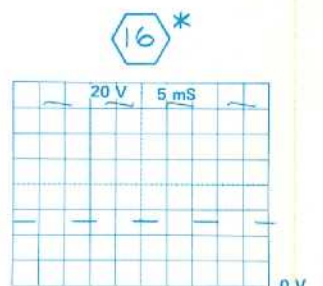
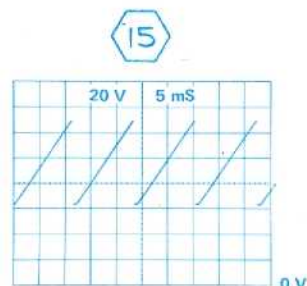
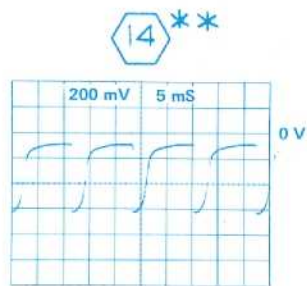
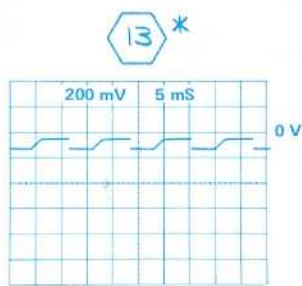
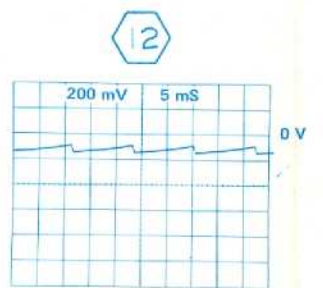
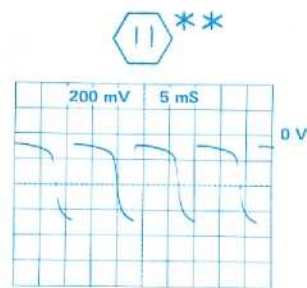
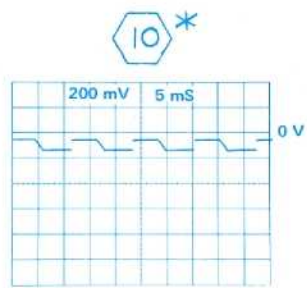
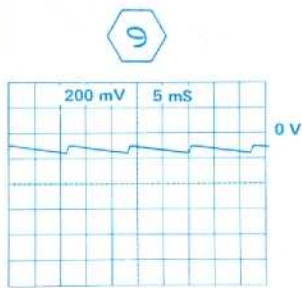
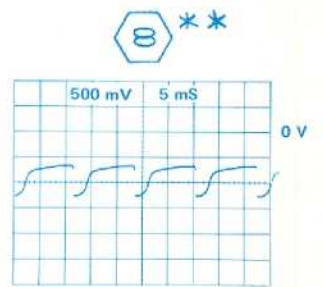
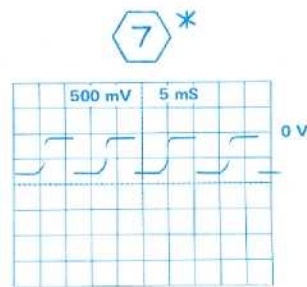
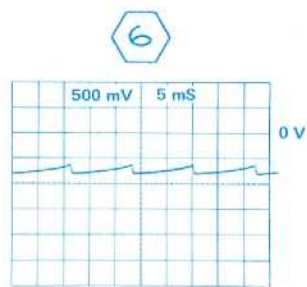
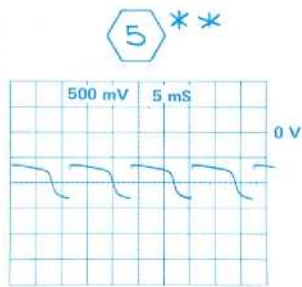
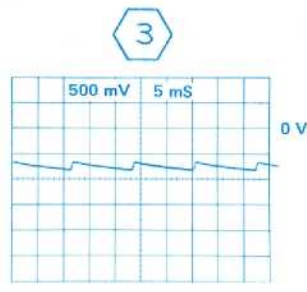
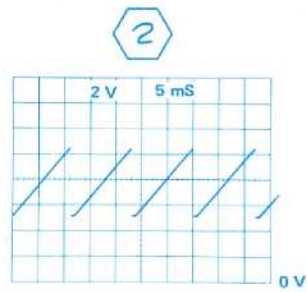
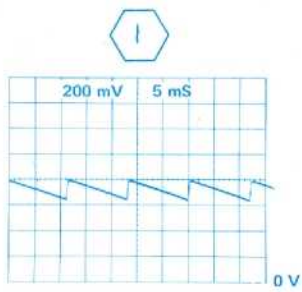
on wht*
rn on wht*



and 8-9 for location of parts not identified here.

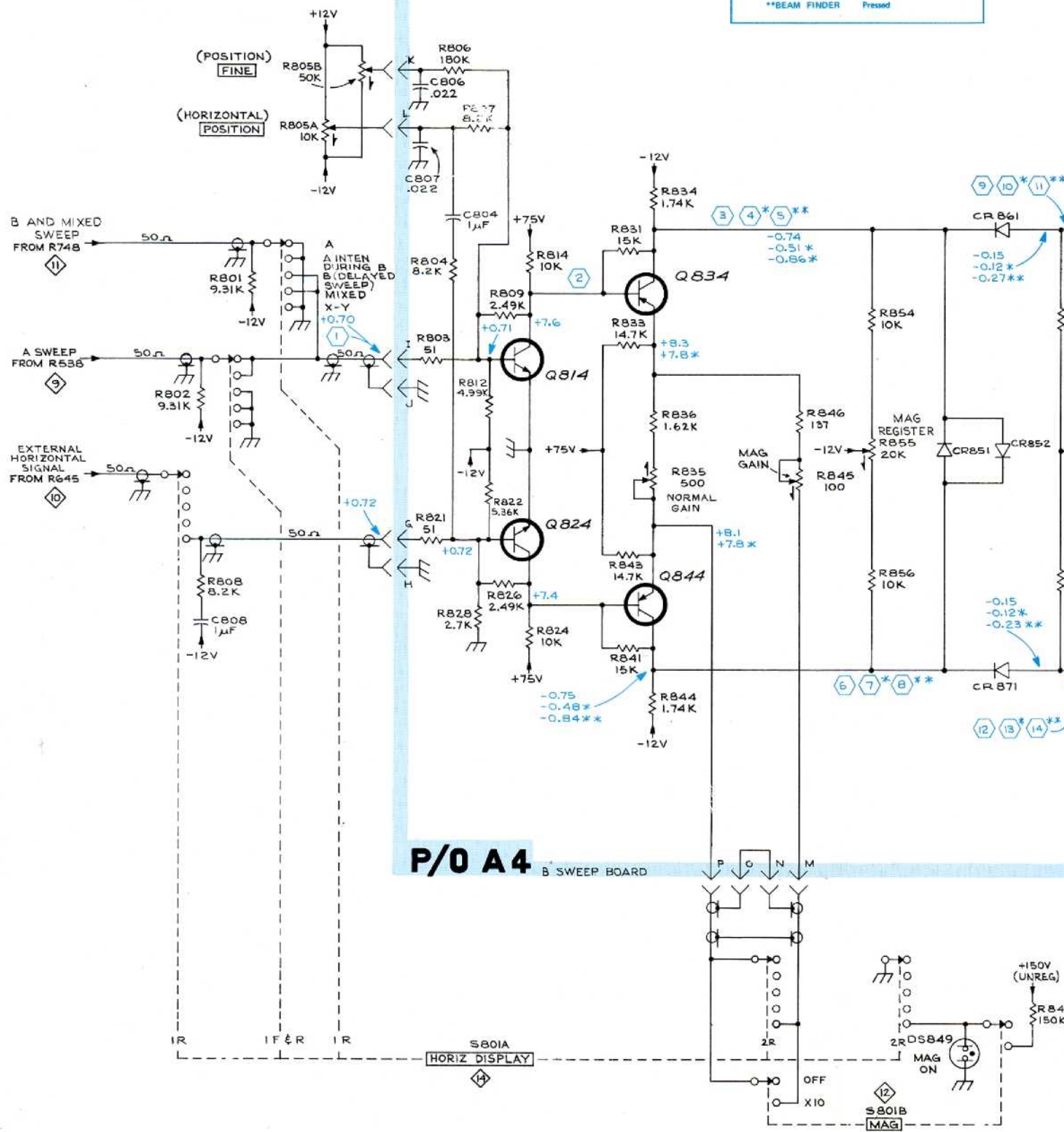


P/O A4. Partial B Sweep circuit board.



← WAVEFORMS

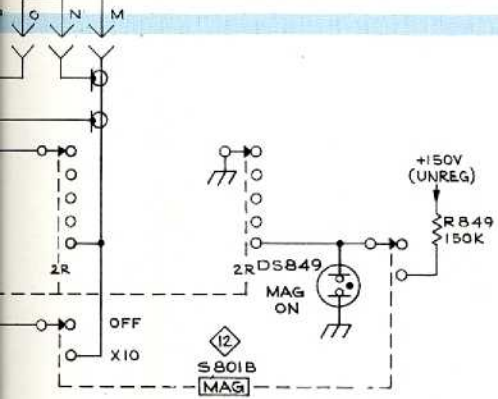
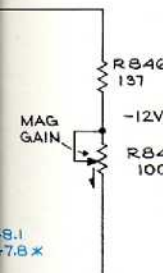
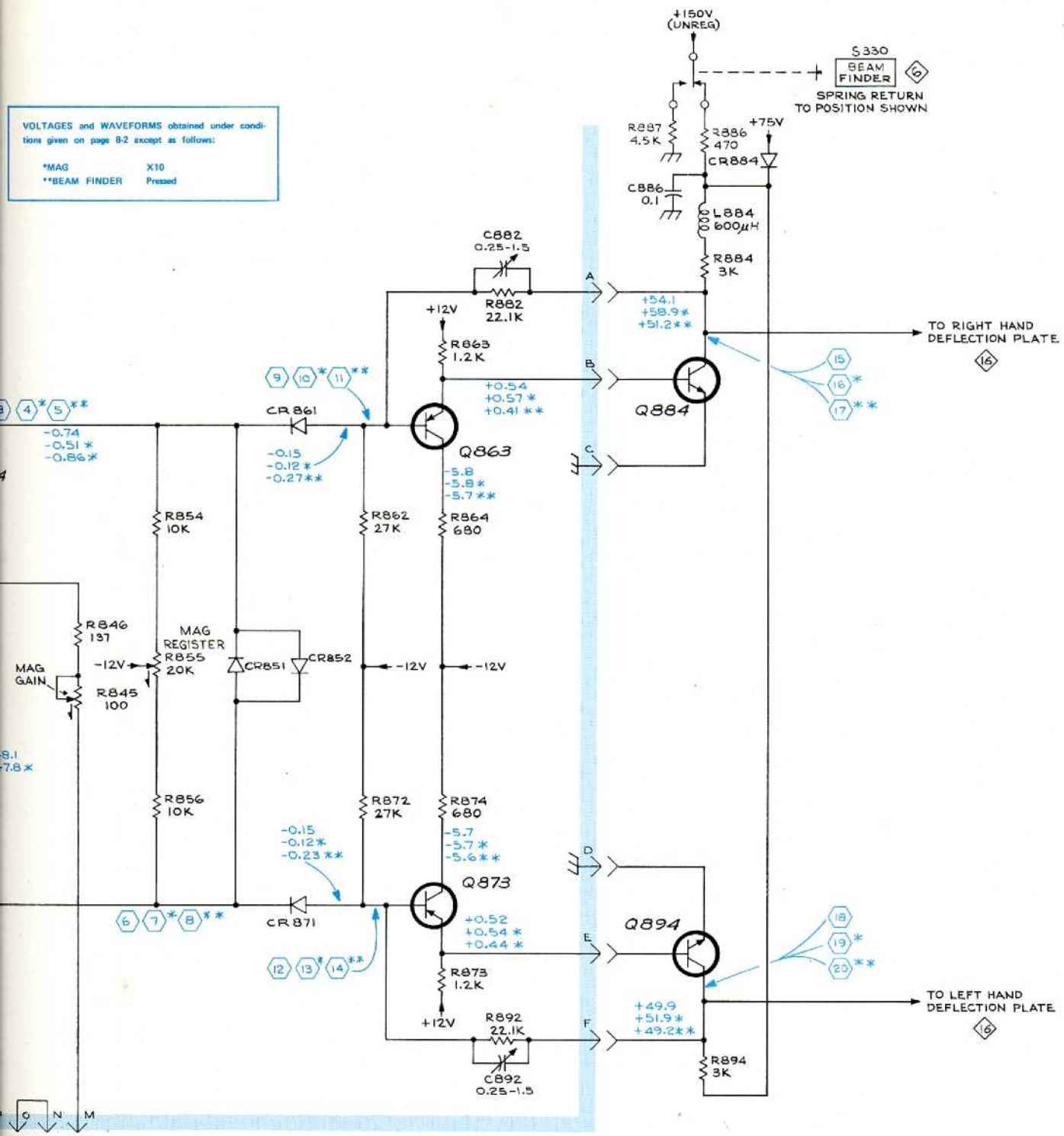
VOLTAGES and WAVEFORMS obtained under conditions given on page B-2 except as follows:
 *MAG X10
 **BEAM FINDER Pressed



P/O A4 B SWEEP BOARD

VOLTAGES and WAVEFORMS obtained under conditions given on page 8-2 except as follows:

*MAG X10
 **BEAM FINDER Pressed



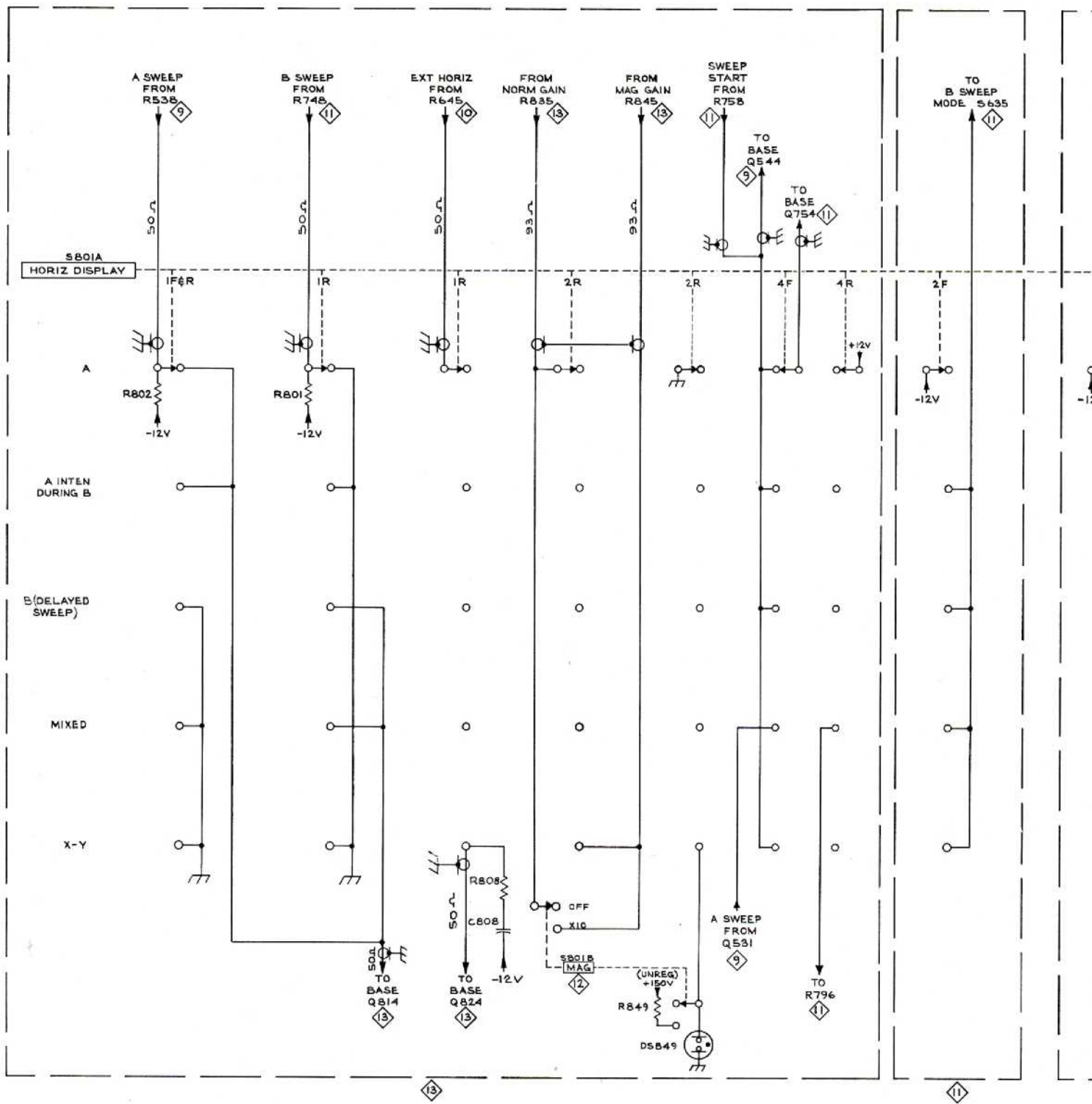
REFERENCE DIAGRAMS

- ⑥ VERTICAL OUTPUT AMPLIFIER
- ⑨ A SWEEP GENERATOR
- ⑩ B TRIGGER GENERATOR
- ⑪ B SWEEP GENERATOR
- ⑫ A & B TIMING SWITCH
- ⑭ HORIZONTAL DISPLAY SWITCH
- ⑮ CRT CIRCUIT

SEE PARTS LIST FOR SEMICONDUCTOR TYPES.

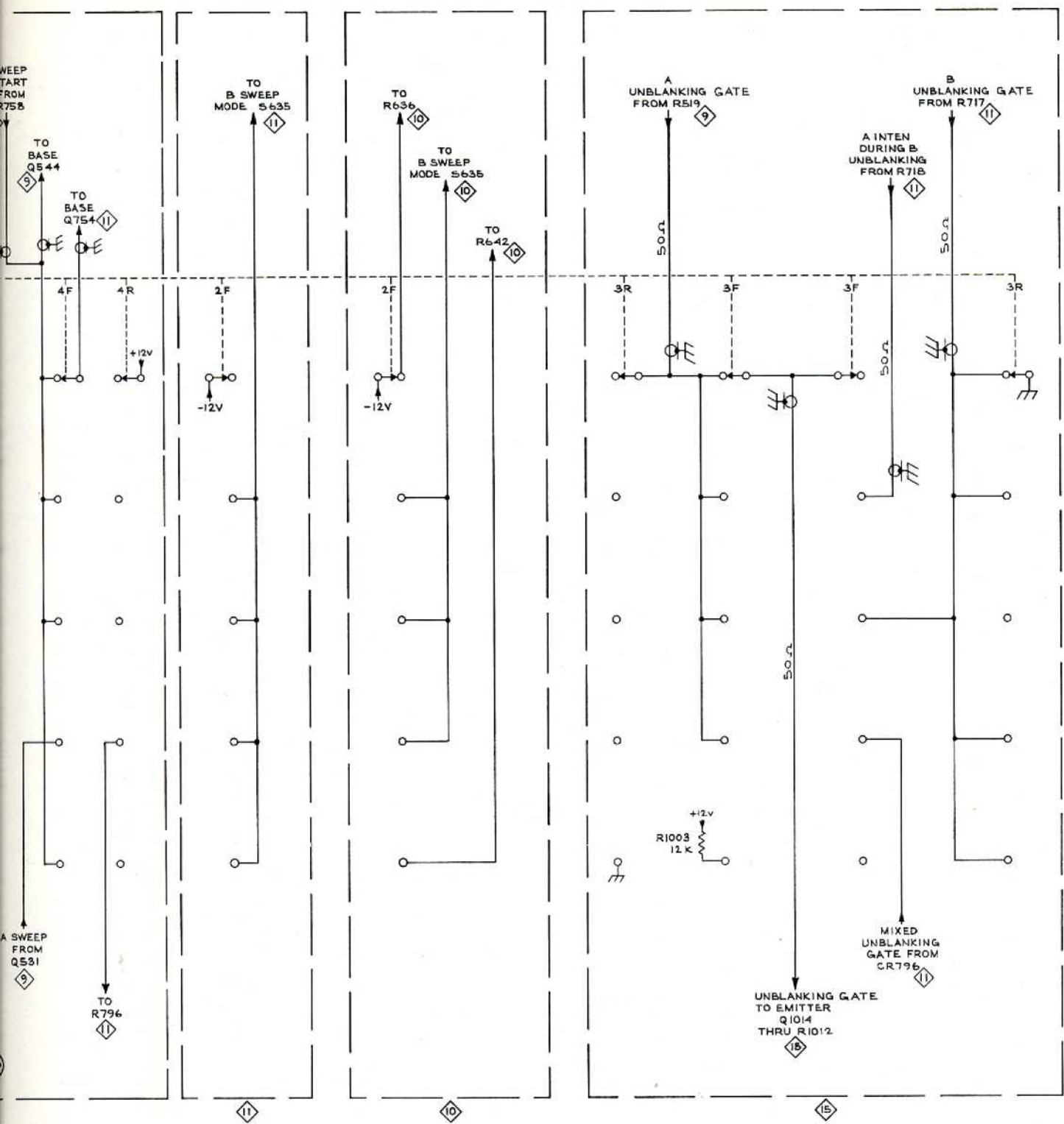
20N 1270

HORIZONTAL AMPLIFIER ⑬



REFERENCE DIAGRAMS

- 9 A SWEEP GENERATOR
- 10 B TRIGGER GENERATOR
- 11 B SWEEP GENERATOR
- 12 A&B TIMING SWITCH
- 13 HORIZONTAL AMPLIFIER
- 15 Z AXIS AMPLIFIER



CMD
1270

(A)

HORIZONTAL DISPLAY SWITCH

(14)

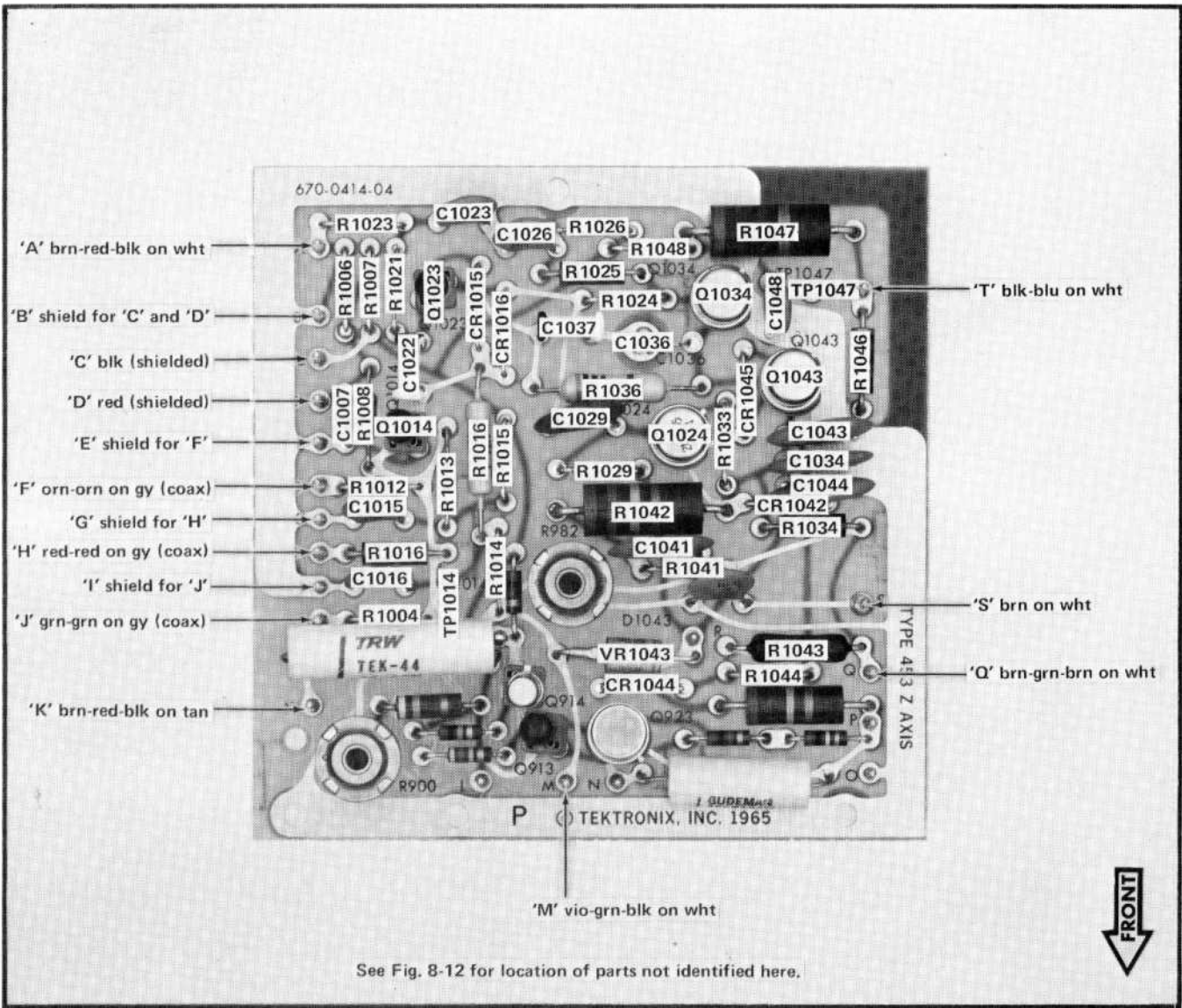
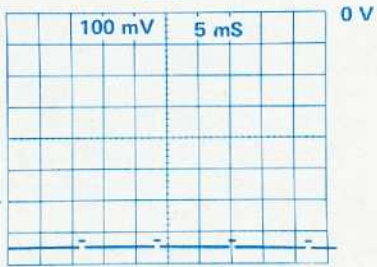
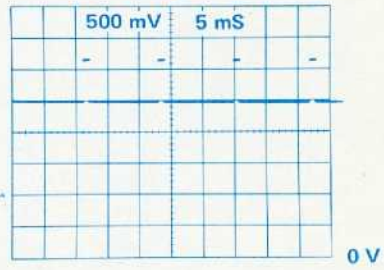


Fig. 8-11. P/O A5. Partial Z Axis circuit board.

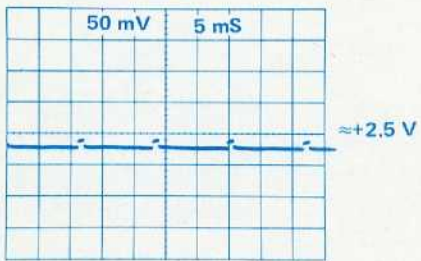
1



2

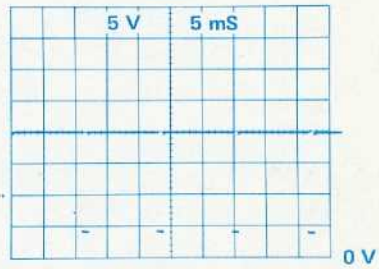


3

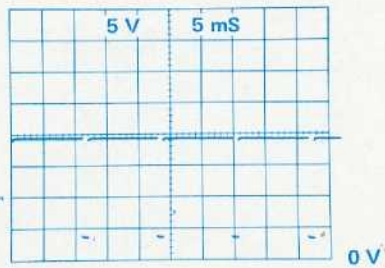


AC COUPLED

4



5



← WAVEFORMS

INTENSITY

R1005
10K

VOLTAGES and WAVEFORMS obtained under conditions given on page 8-2.

VERTICAL CHOPPED BLANKING FROM R245 (5)

Z AXIS INPUT

TO C979 (16)

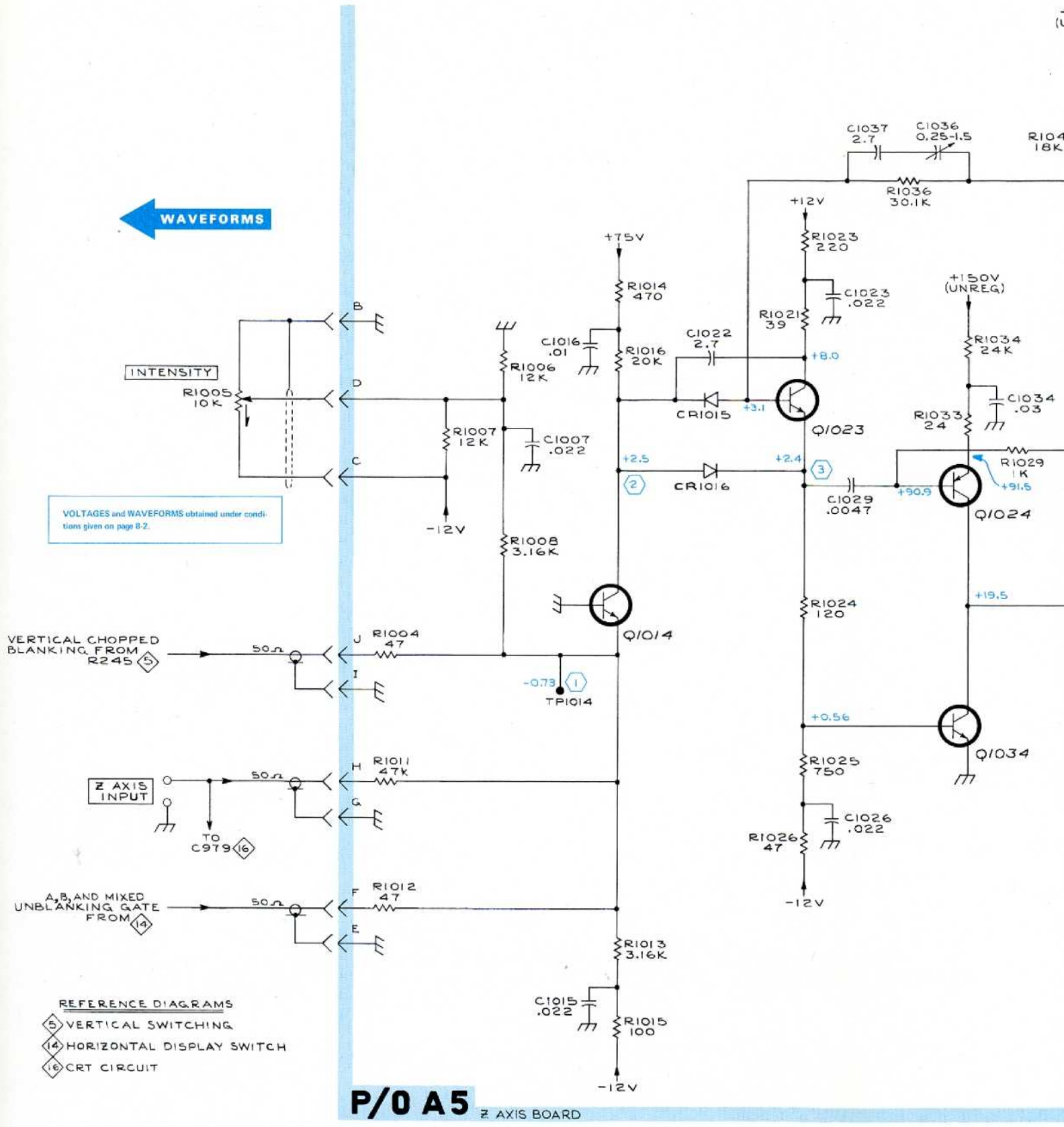
A, B, AND MIXED UNBLANKING GATE FROM (14)

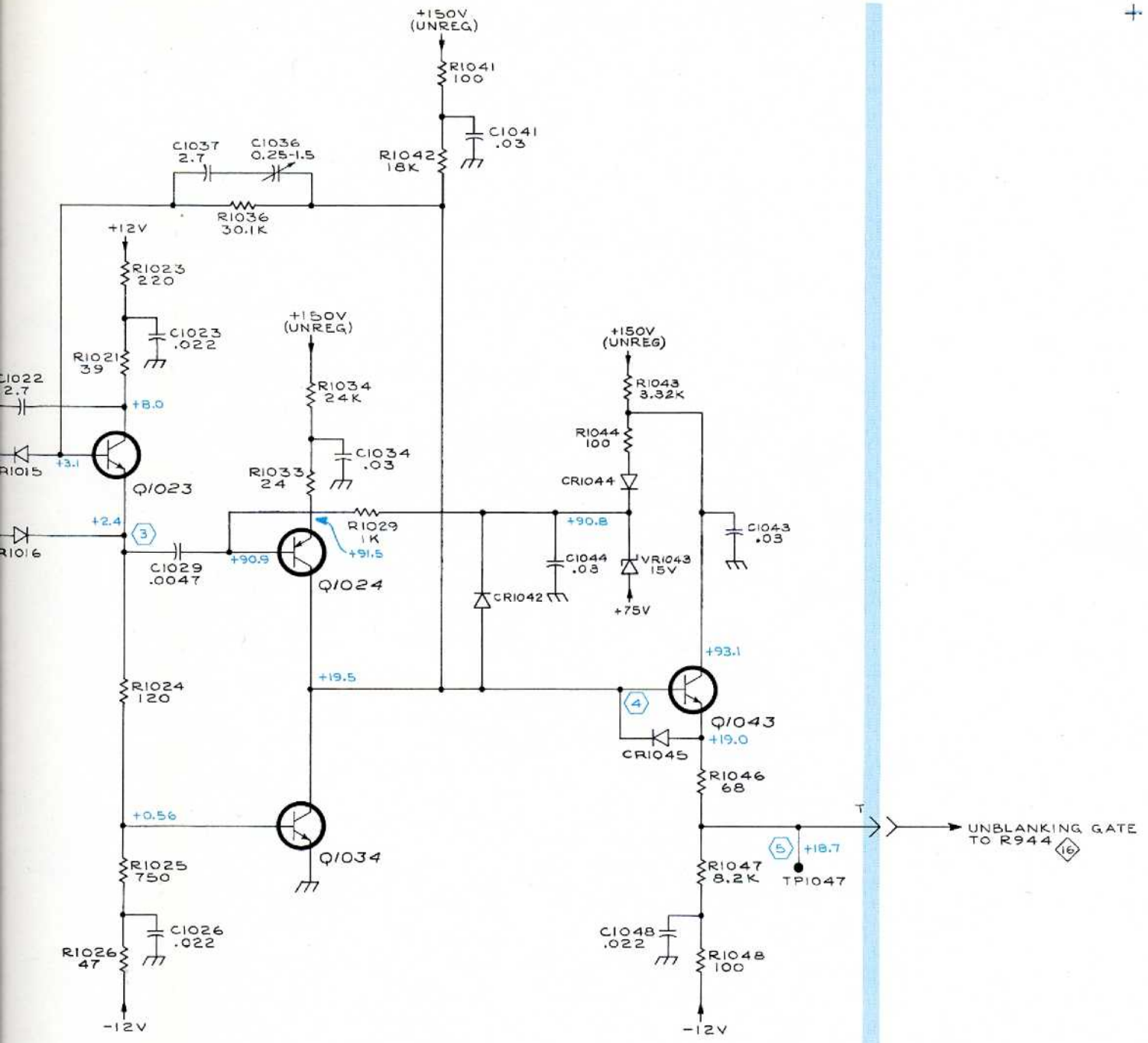
REFERENCE DIAGRAMS

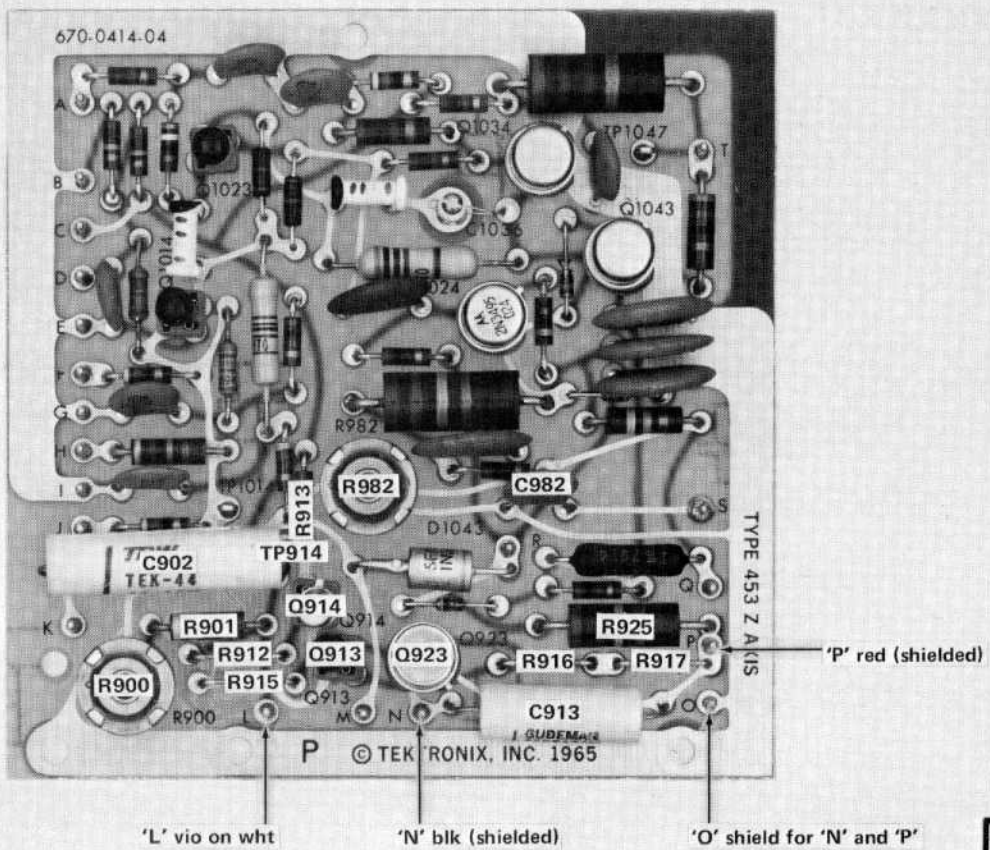
- (5) VERTICAL SWITCHING
- (14) HORIZONTAL DISPLAY SWITCH
- (16) CRT CIRCUIT

P/O A5 Z AXIS BOARD

SEE PARTS LIST FOR SEMICONDUCTOR TYPES

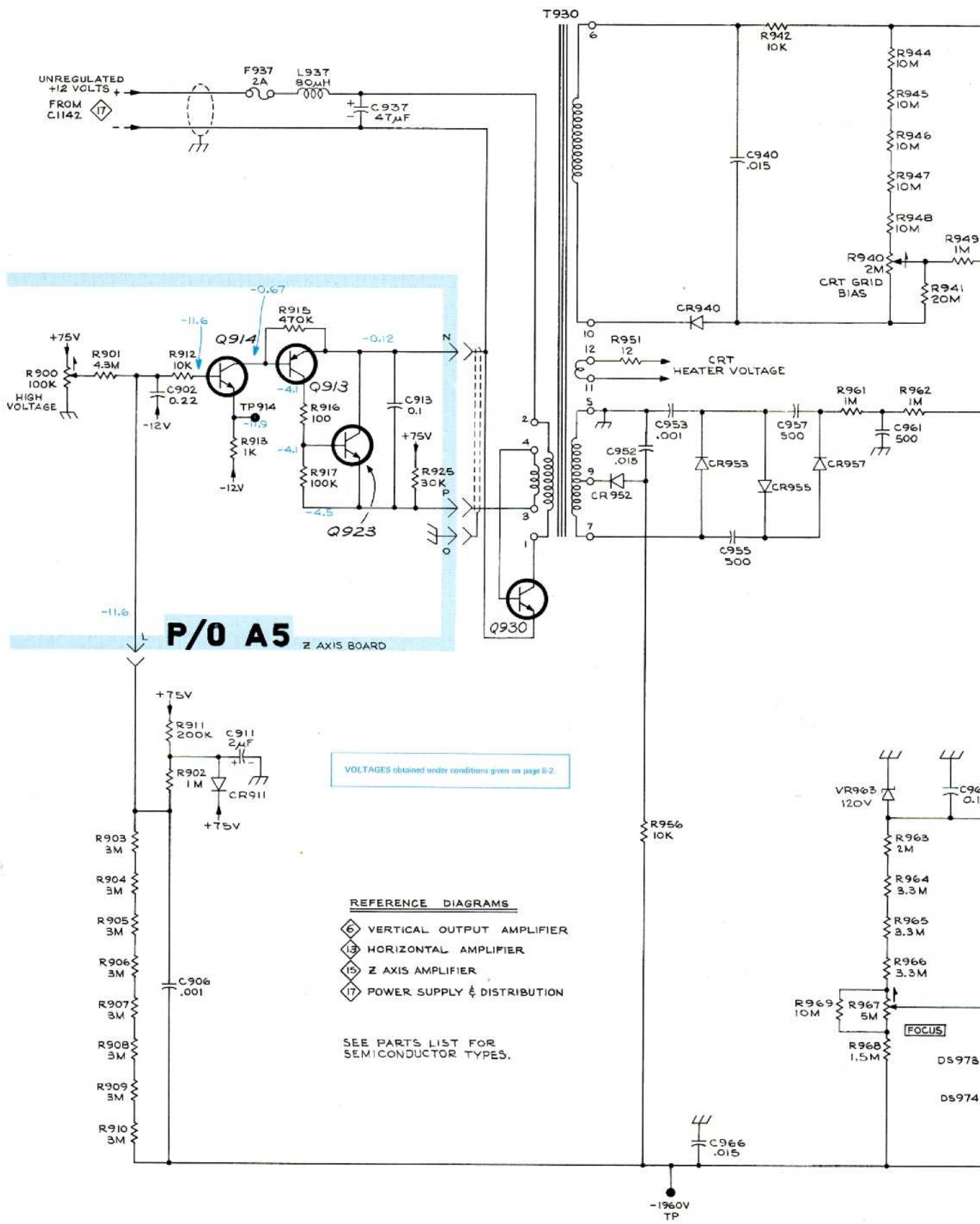


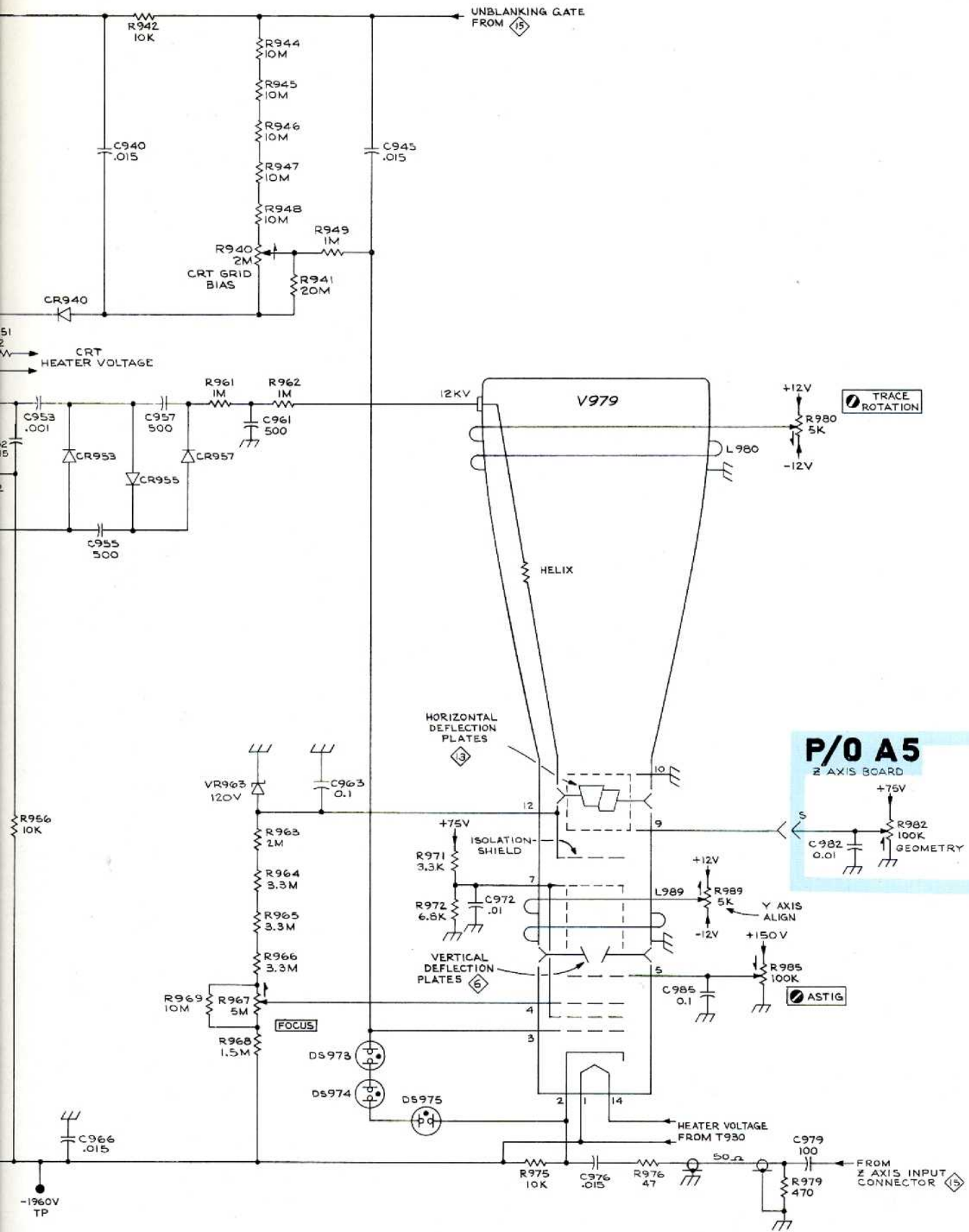




See Fig. 8-11 for location of parts not identified here.

Fig. 8-12. P/O A5. Partial Z Axis circuit board.





(A)₁

CRT CIRCUIT 16

DON
1270

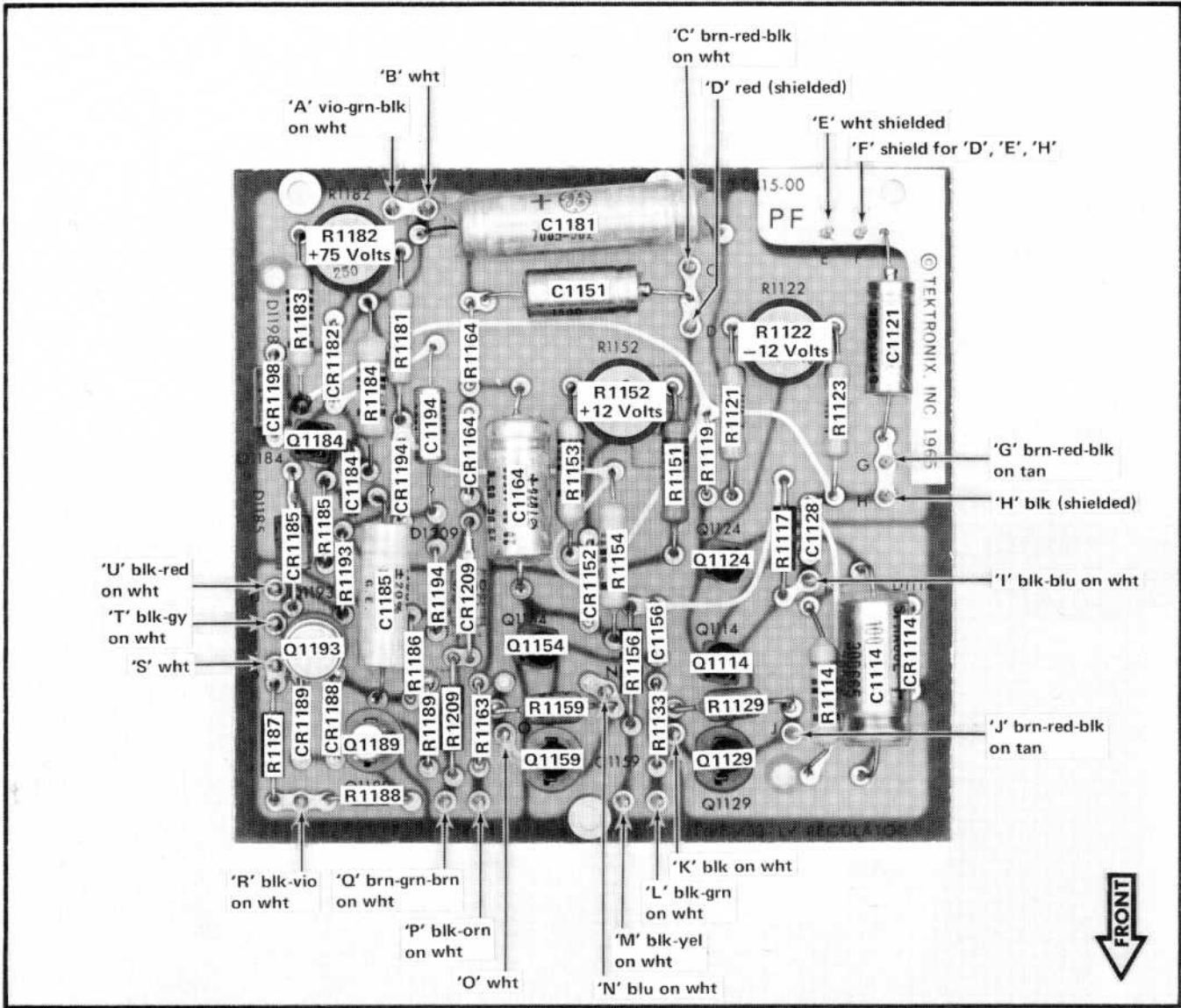
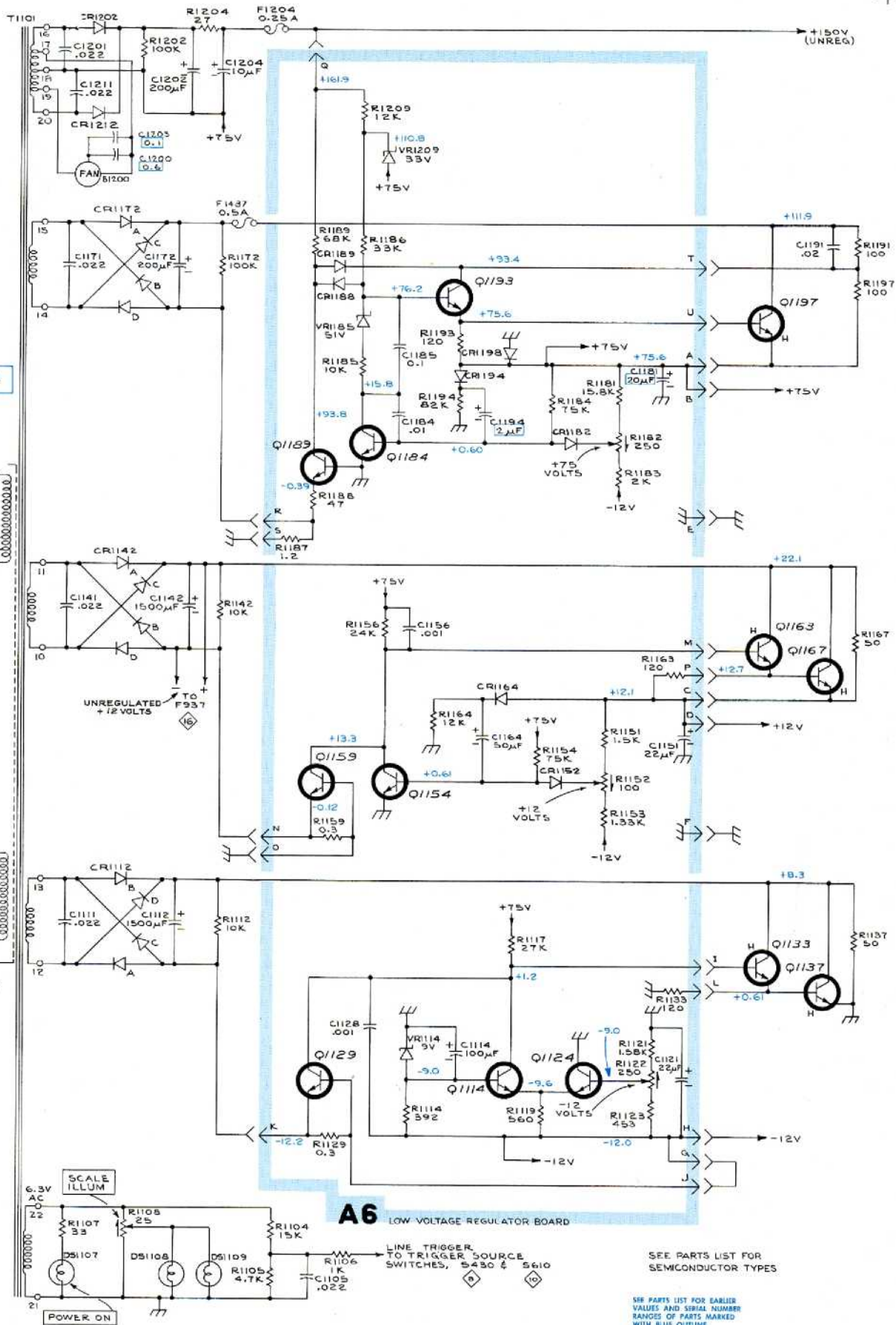
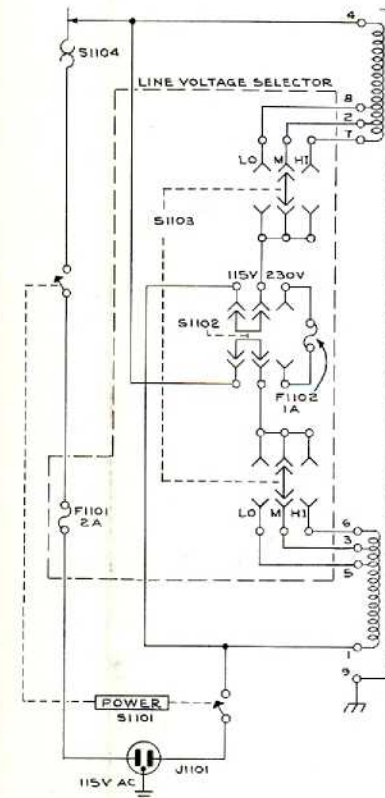


Fig. 8-13. A6. Low Voltage Regulator circuit board.



VOLTAGES obtained under conditions given on page B-2.

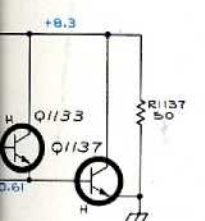
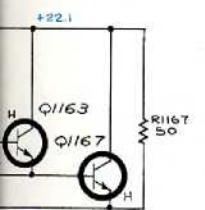
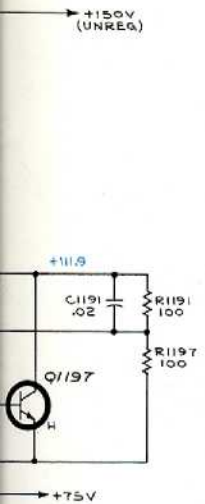


- REFERENCE DIAGRAMS
- 1 CHANNEL 1 VERTICAL PREAMP
 - 2 CHANNEL 2 VERTICAL PREAMP
 - 3 VERTICAL SWITCHING
 - 4 VERTICAL OUTPUT AMPLIFIER
 - 5 TRIGGER PREAMP
 - 6 A TRIGGER GENERATOR
 - 7 A SWEEP GENERATOR
 - 8 B TRIGGER GENERATOR
 - 9 B SWEEP GENERATOR
 - 10 HORIZONTAL AMPLIFIER
 - 11 Z AXIS AMPLIFIER
 - 12 CRT CIRCUIT
 - 13 CALIBRATOR

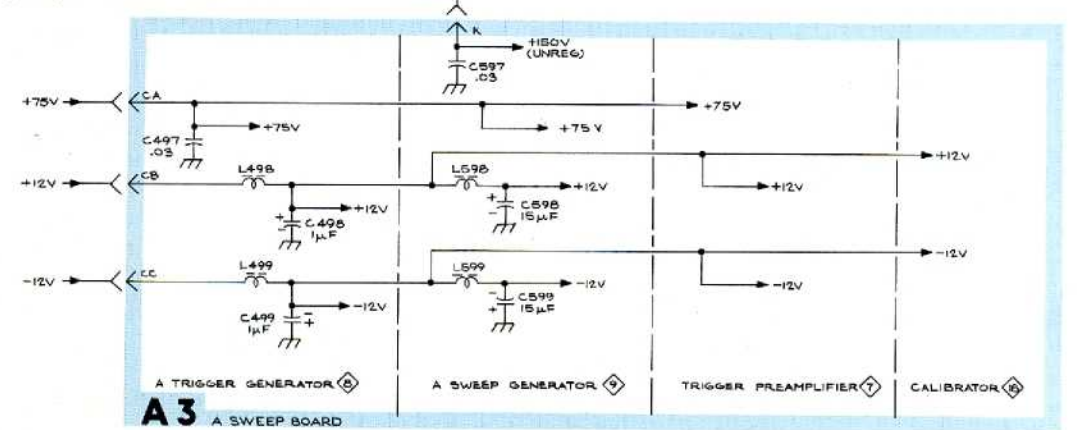
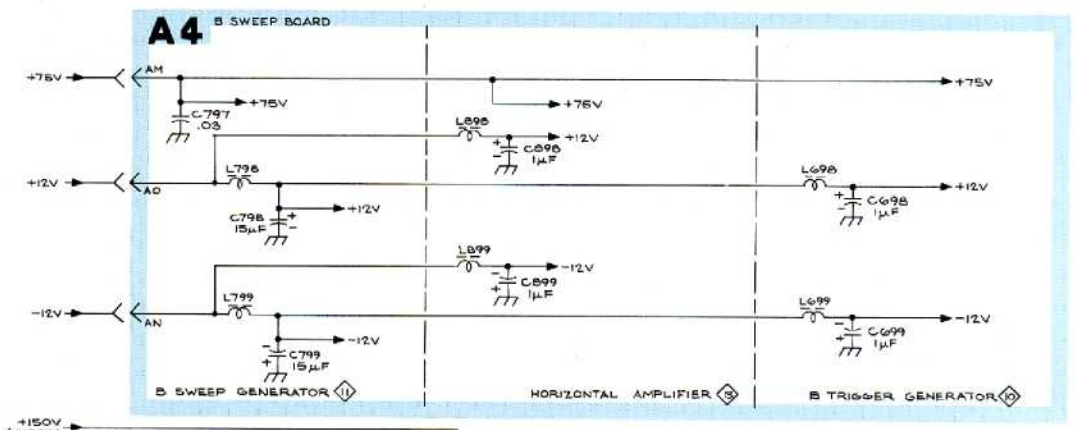
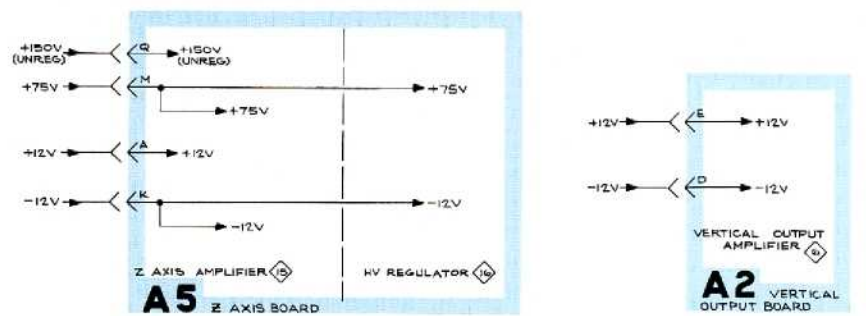
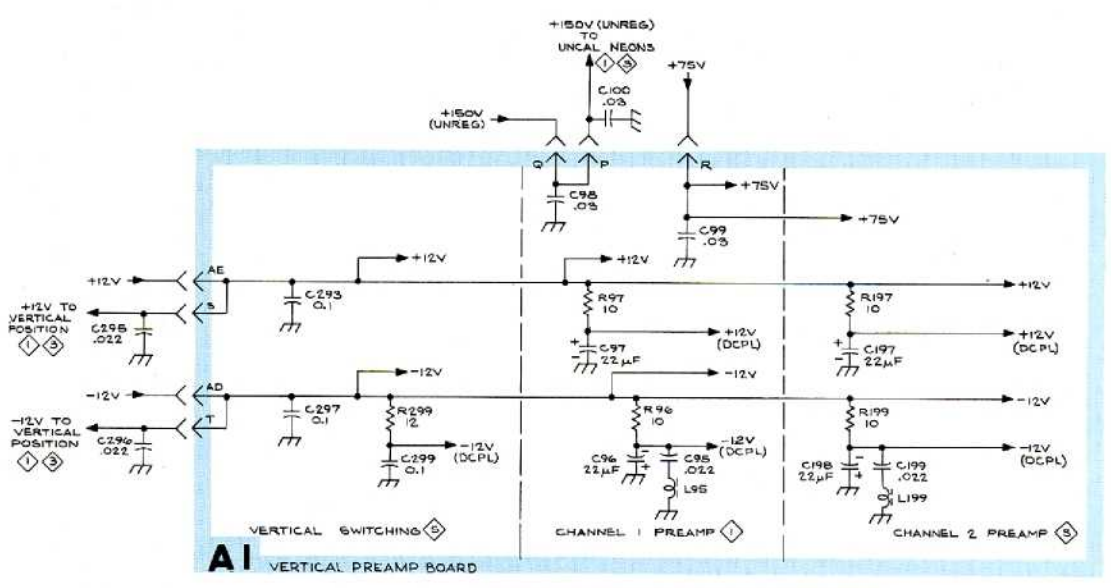
A6 LOW VOLTAGE REGULATOR BOARD

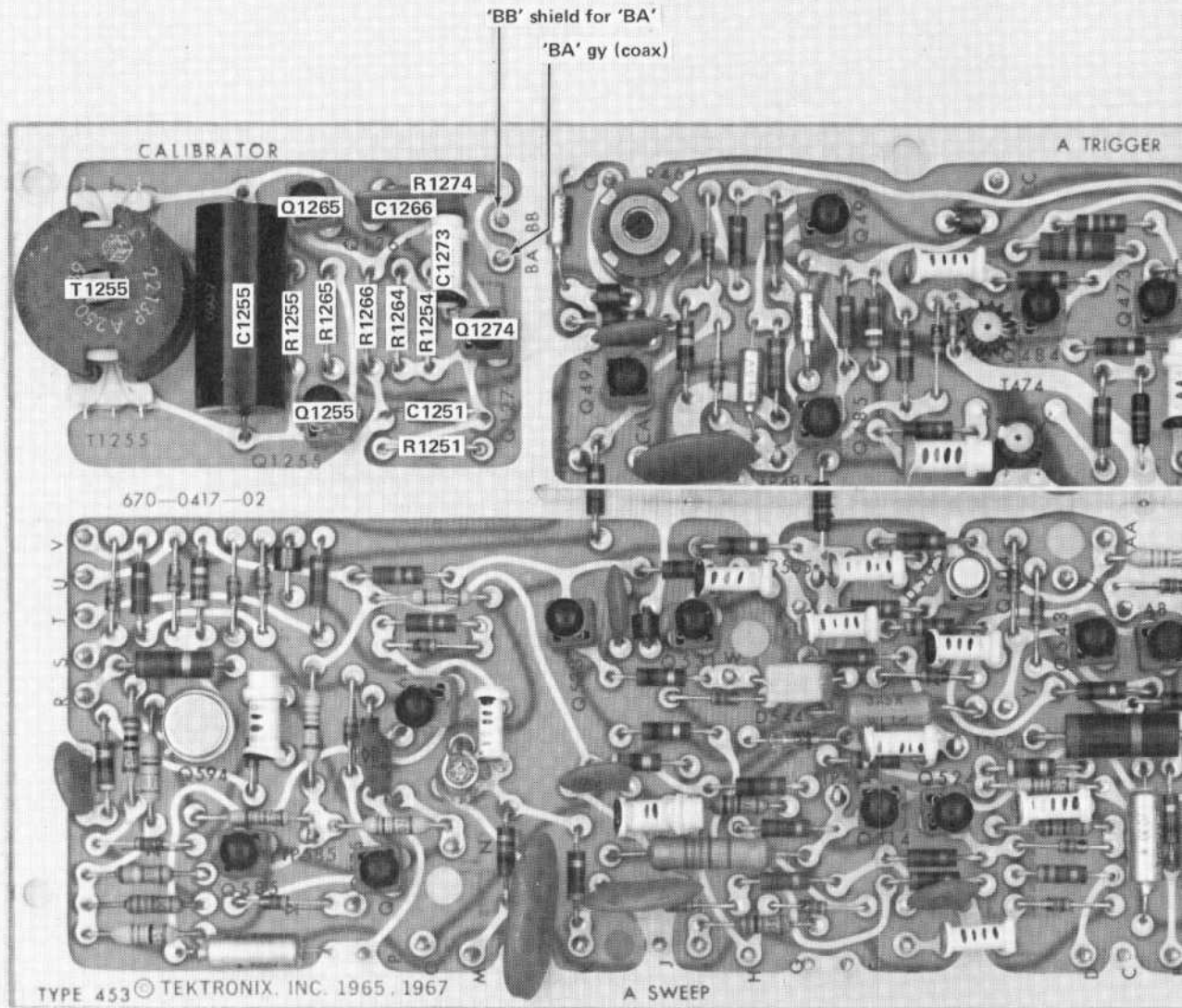
SEE PARTS LIST FOR SEMICONDUCTOR TYPES

SEE PARTS LIST FOR EARLIER VALUES AND SERIAL NUMBER RANGES OF PARTS MARKED WITH BLUE OUTLINE



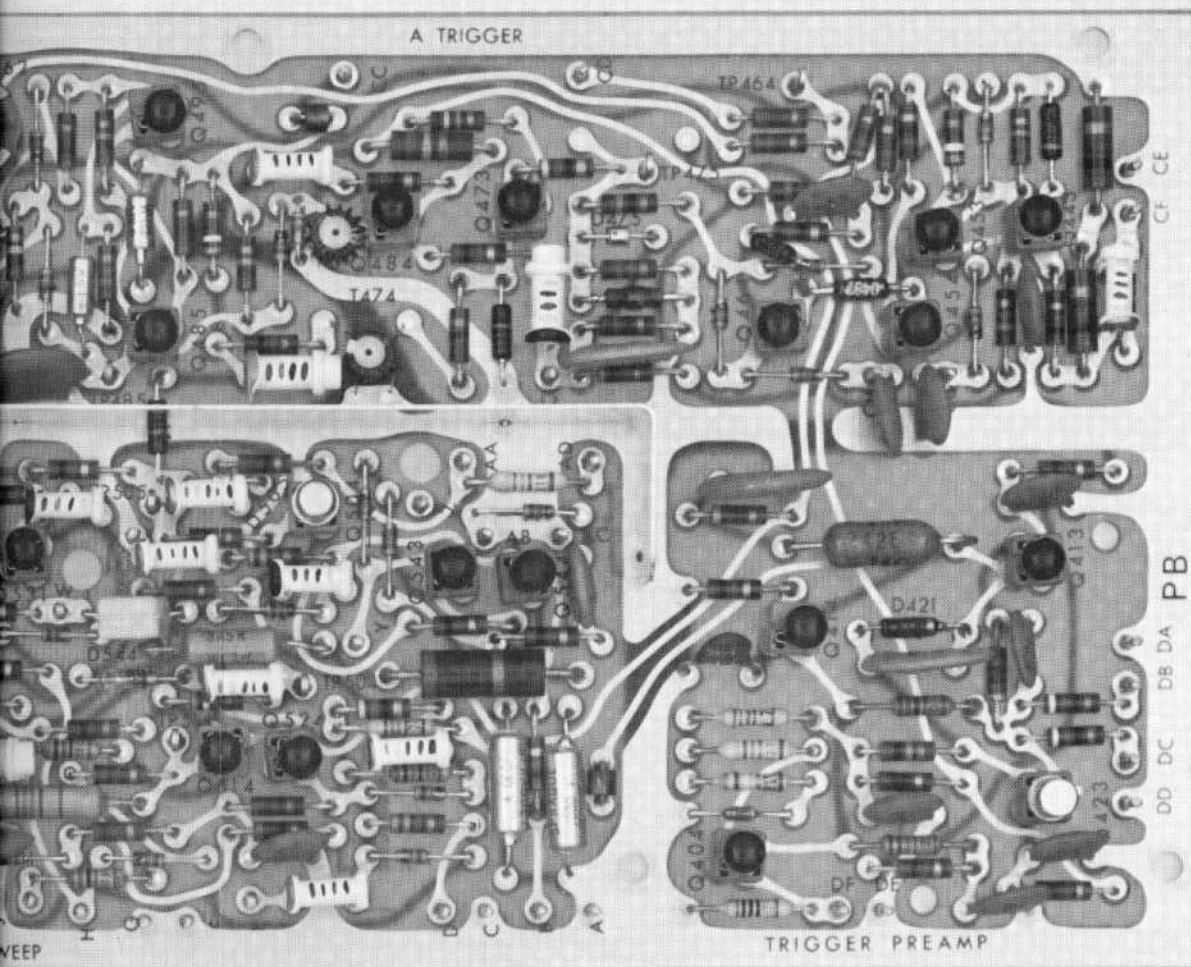
FOR
TYPES





See Figs. 8-5, 8-6 and 8-7 for location of parts not identified here.

Fig. 8-14. P/O A3. Partial A Sweep board.

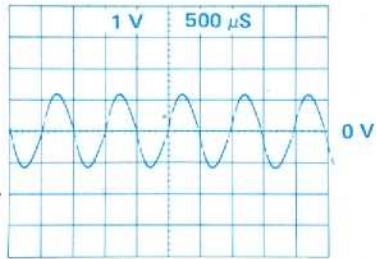


8-5, 8-6 and 8-7 for location of parts not identified here.

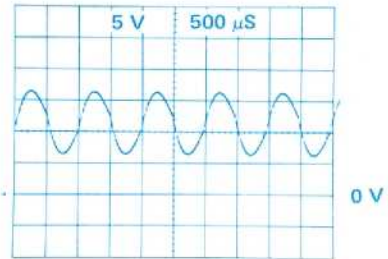


Fig. 8-14. P/O A3. Partial A Sweep board.

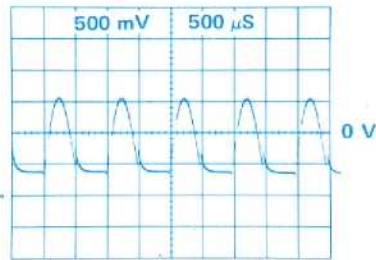
1



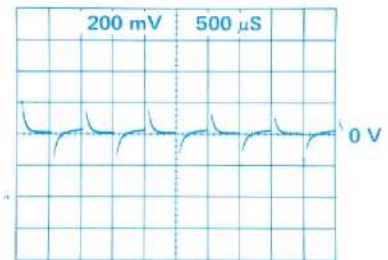
2



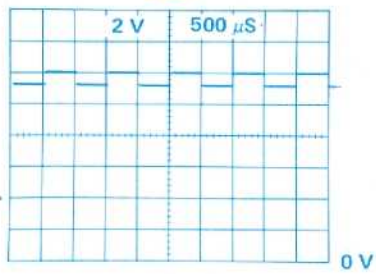
3



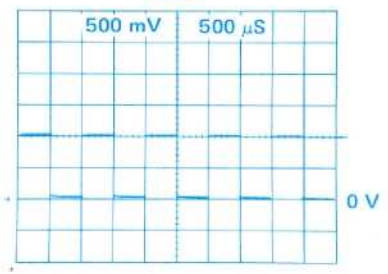
4



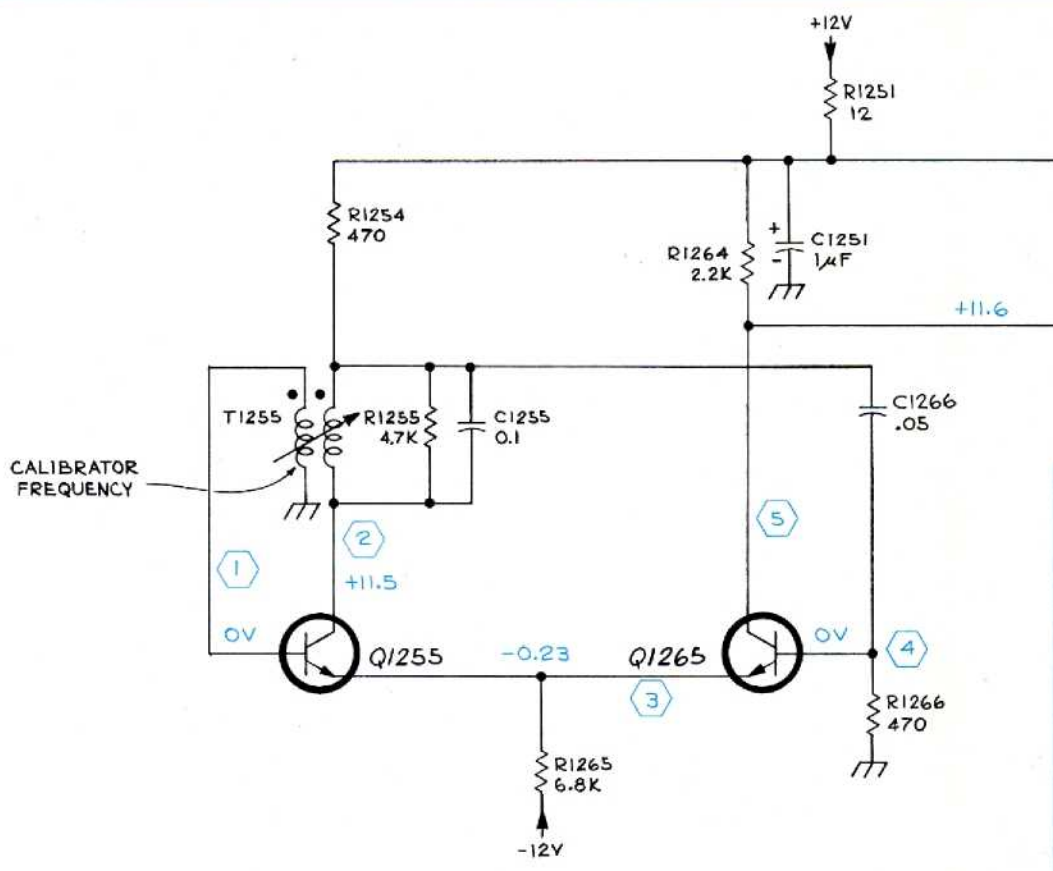
5



6



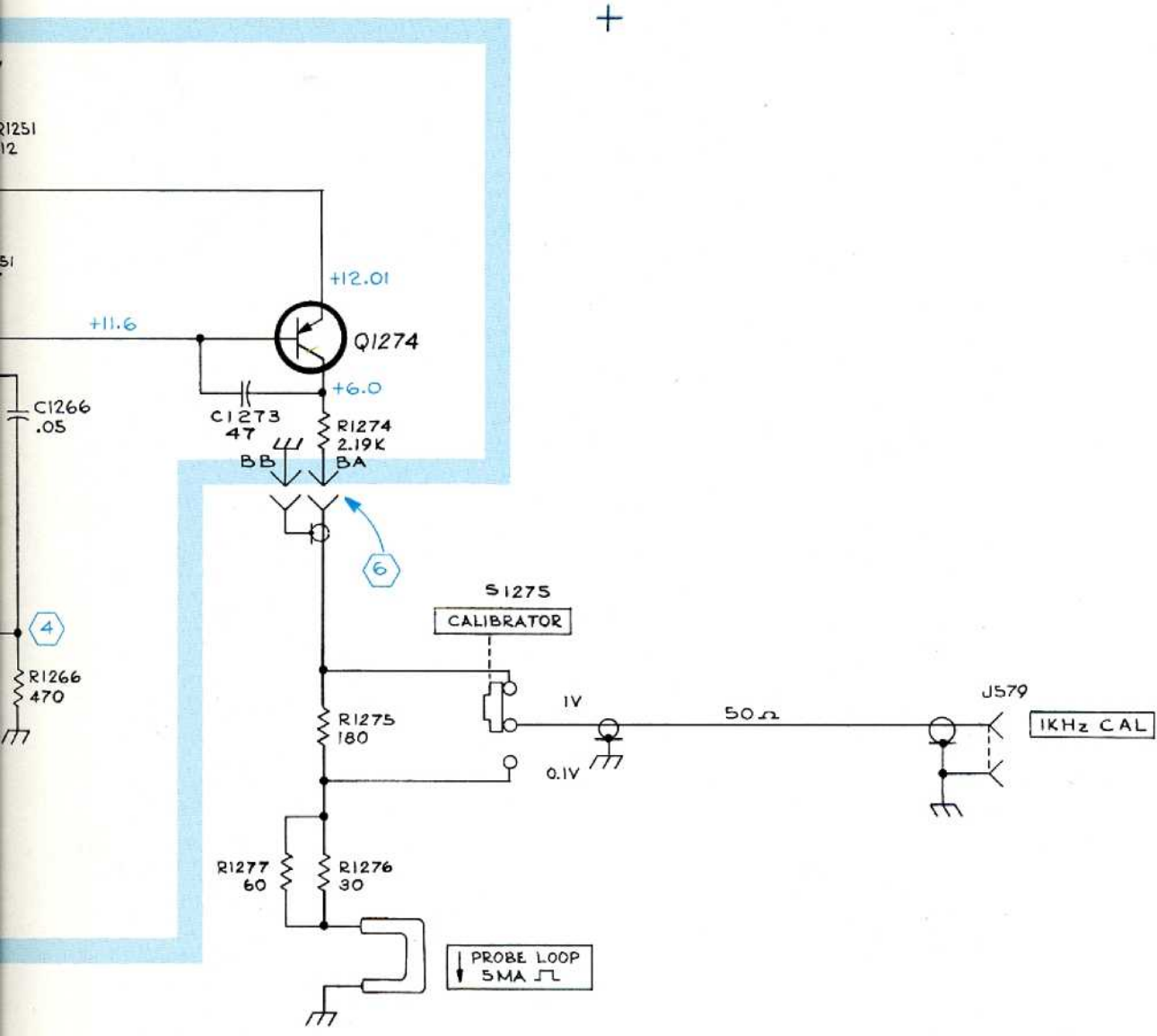
← WAVEFORMS



P/O A3

A SWEEP BOARD

VOLTAGES and WAVEFORMS obtained under conditions given on page B-2.



SEE PARTS LIST FOR SEMICONDUCTOR TYPES

JN
1270
CALIBRATOR 18

CALIBRATOR

18

FIGURE AND INDEX NUMBERS

Items in this section are referenced by figure and index numbers to the illustrations which appear either on the back of the diagrams or on pullout pages immediately following the diagrams of the instruction manual.

INDENTATION SYSTEM

This mechanical parts list is indented to indicated item relationships. Following is an example of the indentation system used in the Description column.

Assembly and/or Component
Detail Part of Assembly and/or Component
mounting hardware for Detail Part
Parts of Detail Part
mounting hardware for Parts of Detail Part
mounting hardware for Assembly and/or Component

Mounting hardware always appears in the same indentation as the item it mounts, while the detail parts are indented to the right. Indented items are part of, and included with, the next higher indentation.

Mounting hardware must be purchased separately, unless otherwise specified.

PARTS ORDERING INFORMATION

Replacement parts are available from or through your local Tektronix, Inc. Field Office or representative.

Changes to Tektronix instruments are sometimes made to accommodate improved components as they become available, and to give you the benefit of the latest circuit improvements developed in our engineering department. It is therefore important, when ordering parts, to include the following information in your order: Part number, instrument type or number, serial or model number, and modification number if applicable.

If a part you have ordered has been replaced with a new or improved part, your local Tektronix, Inc. Field Office or representative will contact you concerning any change in part number.

Change information, if any, is located at the rear of this manual.

ABBREVIATIONS AND SYMBOLS

For an explanation of the abbreviations and symbols used in this section, please refer to the page immediately preceding the Electrical Parts List in this instruction manual.

**INDEX OF
MECHANICAL & REPACKAGING PARTS ILLUSTRATIONS
AND PARTS LIST**

Title	Page Nos. of Parts List
Figure 1 Front & Crt Shield	9-1 thru 9-8
Figure 2 Attenuator & High Voltage	9-9 thru 9-13
Figure 3 Chassis	9-14 thru 9-21
Figure 4 453A Frame & Cabinet	9-22 thru 9-24
Figure 5 R453A Cabinet	9-25 thru 9-26
Figure 6 Standard Accessories	(Parts list combined with illustration)
Figure 7 453A Repackaging	(Parts list combined with illustration)
Figure 8 R453A Repackaging	(Parts list combined with illustration)

SECTION 9

MECHANICAL PARTS LIST

FIGURE 1 FRONT & CRT SHIELD

Fig. & Index No.	Tektronix Part No.	Serial/Model No.		Q † y	Description
		Eff	Disc		
1-1	337-0964-00	B010100	B090000X	1	SHIELD, light
	331-0272-00	B010100	B099999	1	MASK-LIGHT REFLECTOR, CRT
	- - - - -			-	mask-light reflector includes:
-2	378-0782-00			1	REFLECTOR, light, plastic
-3	331-0270-00			1	MASK, graticlue
	331-0270-01	B100000		1	MASK, CRT graticule
	378-0782-00	B100000		1	REFLECTOR, light, plastic
-4	386-1784-00			1	LIGHT CONDUCTOR, graticlue
-5	344-0220-00			1	CLIP, spring tension
-6	348-0070-01			4	CUSHION, CRT
-7	337-1414-00			1	SHIELD, light
-8	136-0396-00			2	SOCKET, graticlue lamp
	- - - - -			-	mounting hardware for each: <i>(not included w/socket)</i>
-9	210-0586-00			1	NUT, keps, 4-40 x 0.25 inch
-10	- - - - -			1	COIL
	- - - - -			-	mounting hardware: <i>(not included w/coil)</i>
-11	213-0149-00			3	SCREW, thread forming, 6-32 x 0.312 inch, PHB
-12	210-0863-00			1	WASHER, D-shape, 0.191 ID x 0.515 inch
-13	343-0042-00			1	CLAMP, cable, plastic, 0.312 inch (half)
-14	343-0123-01			2	CLAMP, CRT retainer
	- - - - -			-	mounting hardware: <i>(not included w/clamp)</i>
-15	211-0600-00			1	SCREW, 6-32 x 2 inches, Fil HS
-16	220-0444-00			1	NUT, square, 6-32 x 0.25 inch
-17	343-0124-00			1	CLAMP, retainer, plastic
	- - - - -			-	mounting hardware: <i>(not included w/clamp)</i>
-18	211-0599-00			2	SCREW, 6-32 x 0.75 inch, Fil HS
-19	220-0444-00			2	NUT, square, 6-32 x 0.25 inch
-20	352-0091-01			2	HOLDER, CRT retainer
	- - - - -			-	mounting hardware for each: <i>(not included w/holder)</i>
-21	211-0590-00			2	SCREW, 6-32 x 0.25 inch, PHB

FIGURE 1 FRONT & CRT SHIELD (cont)

Fig. & Index No.	Tektronix Part No.	Serial/Model Eff	No. Disc	Q t y	1 2 3 4 5					Description
1-22	343-0131-00			1						CLAMP, coil from
				-						mounting hardware: <i>(not included w/clamp)</i>
-23	211-0590-00			2						SCREW, 6-32 x 0.25 inch, PHB
-24	210-0006-00			2						WASHER, lock, internal, 0.146 ID x 0.283 inch OD
-25	210-0407-00			2						NUT, hex., 6-32 x 0.25 inch
-26	358-0281-00			1						BUSHING, CRT cable
-27	337-1010-01			1						SHIELD, CRT
				-						mounting hardware: <i>(not included w/shield)</i>
-28	211-0510-00			2						SCREW, 6-32 x 0.375 inch, PHS
-29	210-0949-00			4						WASHER, flat, 0.141 ID x 0.50 inch OD
-30	213-0049-00			2						SCREW, 6-32 x 0.312 inch, HHB
-31	343-0122-01			2						CLAMP, CRT shield
-32	175-0582-00			1						WIRE, CRT lead
	175-0583-00			1						WIRE, CRT lead
	175-0584-00			1						WIRE, CRT lead
	175-0596-00			1						WIRE, CRT lead
				-						each wire includes:
	131-0049-00			1						CONNECTOR, terminal
-33	179-1001-00			1						WIRING HARNESS, graticule light
-34	179-0997-02			1						WIRING HARNESS, anode
				-						wiring harness includes:
-35	131-0371-00			9						CONNECTOR, terminal
	131-0406-00			1						CONNECTOR, anode
				-						connector includes:
-36	131-0206-00			1						CONNECTOR, anode clip
-37	200-0544-00			1						COVER, anode connector
-38	366-0494-00			1						KNOB, charcoal—INTENSITY
				-						knob includes:
	213-0153-00			1						SETSCREW, 5-40 x 0.125 inch, HSS
-39	366-0494-00			1						KNOB, charcoal—FOCUS
				-						knob includes:
	213-0153-00			1						SETSCREW, 5-40 x 0.125 inch, HSS
-40	366-0494-00			1						KNOB, charcoal—SCALE ILLUM
				-						knob includes:
	213-0153-00			1						SETSCREW, 5-40 x 0.125 inch, HSS
-41	366-0494-00			1						KNOB, charcoal—POSITION (CH 1)
				-						knob includes:
	213-0153-00			1						SETSCREW, 5-40 x 0.125 inch, HSS
-42	366-0494-00			1						KNOB, charcoal—POSITION (CH 2)
				-						knob includes:
	213-0153-00			1						SETSCREW, 5-40 x 0.125 inch, HSS
-43	366-0493-01			2						KNOB, red—VARIABLE (CH 1 & 2)
				-						each knob includes:
	213-0153-00			1						SETSCREW, 5-40 x 0.125 inch, HSS

FIGURE 1 FRONT & CRT SHIELD (cont)

Fig. & Index No.	Tektronix Part No.	Serial/Model No. Eff	No. Disc	Q					Description	
				t	y	1	2	3		4
1-44	366-1001-00			2						KNOB, charcoal—VOLTS/DIV (CH1&2)
	- - - - -			-						each knob includes:
	213-0153-00			2						SETSCREW, 5-40 x 0.125 inch, HSS
-45	366-1247-00			1						KNOB, red—A&B VARIABLE
	- - - - -			-						knob includes:
	213-0153-00			1						SETSCREW, 5-40 x 0.125 inch, HSS
-46	366-1248-00			1						KNOB, charcoal—A&B TIME/DIV & DELAY TIME
	- - - - -			-						knob includes:
	213-0022-00			2						SETSCREW, 4-40 x 0.188 inch, HSS
-47	334-1598-00			1						PLATE, information
-48	354-0385-00			1						RING, knob skirt
	- - - - -			-						ring includes:
	213-0022-00			2						SETSCREW, 4-40 x 0.188 inch, HSS
-49	366-1057-00			1						KNOB, gray—INT TRIG
	- - - - -			-						knob includes:
	213-0153-00			1						SETSCREW, 5-40 x 0.125 inch, HSS
-50	366-1057-00			1						KNOB, gray—MAG
	- - - - -			-						knob includes:
	213-0153-00			1						SETSCREW, 5-40 x 0.125 inch
-51	366-1163-00			1						KNOB, charcoal—MODE
	- - - - -			-						knob includes:
	213-0153-00			2						SETSCREW, 5-40 x 0.125 inch
-52	366-1163-00			1						KNOB, charcoal—HORIZ DISPLAY
	- - - - -			-						knob includes:
	213-0153-00			2						SETSCREW, 5-40 x 0.125 inch
-53	366-1039-00			1						KNOB, charcoal—A SWEEP LENGTH
	- - - - -			-						knob includes:
	213-0153-00			1						SETSCREW, 5-40 x 0.125 inch
-54	366-1039-00			1						KNOB, charcoal—LEVEL (B TRIGGERING)
	- - - - -			-						knob includes:
	213-0153-00			1						SETSCREW, 5-40 x 0.125 inch
-55	366-1244-00			1						KNOB, gray—HF STAB
	- - - - -			-						knob includes:
	213-0153-00			2						SETSCREW, 5-40 x 0.125 inch, HSS
-56	366-1244-00			1						KNOB, gray—FINE
	- - - - -			-						knob includes:
	213-0153-00			2						SETSCREW, 5-40 x 0.125 inch, HSS
-57	366-1246-00			1						KNOB, charcoal—LEVEL (A TRIGGERING)
	- - - - -			-						knob includes:
	213-0153-00			2						SETSCREW, 5-40 x 0.125 inch, HSS
-58	366-1246-00			1						KNOB, charcoal—POSITION
	- - - - -			-						knob includes:
	213-0153-00			2						SETSCREW, 5-40 x 0.125 inch, HSS
-59	366-0215-02			10						KNOB, lever switch

FIGURE 1 FRONT & CRT SHIELD (cont)

Fig. & Index No.	Tektronix Part No.	Serial/Model Eff	No. Disc	Q † y	Description					
					1	2	3	4	5	
1-60	- - - - -			3	RESISTOR, variable					
	- - - - -			-	mounting hardware for each: <i>(not included w/resistor)</i>					
-61	210-0583-00			2	NUT, hex., 0.25-32 x 0.312 inch					
-62	210-0940-00			1	WASHER, flat, 0.25 ID x 0.375 inch OD					
-63	210-0046-00			1	WASHER, lock, internal, 0.25 ID x 0.40 inch OD					
-64	200-0608-00			1	COVER, variable resistor					
-65	260-0688-00			1	SWITCH, pushbutton—BEAM FINDER					
	- - - - -			-	mounting hardware: <i>(not included w/switch)</i>					
-66	210-0583-00			2	NUT, hex., 0.25-32 x 0.312 inch					
-67	210-0940-00			1	WASHER, flat, 0.25 ID x 0.375 inch OD					
-68	210-0011-00			1	WASHER, lock, internal, 0.25 ID x 0.375 inch OD					
-69	179-0996-00			1	WIRING HARNESS, main					
	- - - - -			-	wiring harness includes,					
-70	131-0371-00			12	CONNECTOR, terminal					
-71	358-0378-00			2	BUSHING, plastic					
-72	- - - - -			1	RESISTOR, variable, w/hardware					
	- - - - -			-	mounting hardware: <i>(not included w/resistor)</i>					
-73	331-0139-00			1	DIAL—DELAY TIME MULTIPLIER					
	- - - - -			-	dial includes:					
	213-0048-00			1	SETSCREW, 4-40 x 0.125 inch, HSS					
-74	260-0717-00			1	SWITCH, pushbutton—RESET					
	- - - - -			-	mounting hardware: <i>(not included w/switch)</i>					
-75	210-0590-00			1	NUT, hex., 0.375-32 x 0.438 inch					
-76	210-0978-00			1	WASHER, flat, 0.375 ID x 0.50 inch OD					
-77	210-0012-00			1	WASHER, lock, internal, 0.375 ID x 0.50 inch OD					
-78	260-0834-00			1	SWITCH, toggle—POWER ON					
	- - - - -			-	mounting hardware: <i>(not included w/switch)</i>					
-79	210-0562-00			1	NUT, hex., 0.25-40 x 0.312 inch					
-80	210-0940-00			1	WASHER, flat, 0.25 ID x 0.375 inch OD					
-81	210-0046-00			1	WASHER, lock, internal, 0.25 ID x 0.40 inch OD					
-82	- - - - -			1	RESISTOR, variable					
	- - - - -			-	mounting hardware: <i>(not included w/resistor)</i>					
-83	358-0029-05			1	BUSHING, hex., 0.50 inch long					
-84	210-0840-00			1	WASHER, flat, 0.39 ID x 0.562 inch OD					
-85	210-0012-00			2	WASHER, lock, internal, 0.375 ID x 0.50 inch OD					
-86	129-0167-00			1	POST, hex., 0.375-32 x 0.50 x 0.688 inch long					

FIGURE 1 FRONT & CRT SHIELD (cont)

Fig. & Index No.	Tektronix Part No.	Serial/Model Eff	No. Disc	Q					Description
				f y	1	2	3	4	
1-87	262-0726-02			1					SWITCH, rotary— A SWEEP LENGTH, wired
	- - - - -			-					switch includes:
	260-0697-01			1					SWITCH, rotary, unwired
-88	- - - - -			1					RESISTOR, variable
	- - - - -			-					mounting hardware: <i>(not included w/resistor)</i>
-89	210-0590-00			2					NUT, hex., 0.375-32 x 0.438 inch
-90	210-0012-00			1					WASHER, lock, internal, 0.375 ID x 0.50 inch OD
-91	376-0014-00			1					COUPLING
	- - - - -			-					mounting hardware: <i>(not included w/switch)</i>
-92	210-0590-00			1					NUT, hex., 0.375-32 x 0.438 inch
-93	210-0978-00			1					WASHER, flat, 0.375 ID x 0.50 inch OD
-94	- - - - -			2					RESISTOR, variable
	- - - - -			-					mounting hardware for each: <i>(not included w/resistor)</i>
-95	210-0590-00			1					NUT, hex., 0.375-32 x 0.438 inch
-96	210-0978-00			1					WASHER, flat, 0.375 ID x 0.50 inch OD
-97	210-0012-00			1					WASHER, lock, internal, 0.375 ID x 0.50 inch OD
-98	333-1361-00			1					PANEL, front
-99	386-1779-02			1					SUBPANEL, front
	129-0103-00			1					BINDING POST ASSEMBLY
	- - - - -			-					binding post assembly includes:
-100	200-0103-00			1					CAP, binding post
-101	129-0077-00			1					POST, binding
	- - - - -			-					mounting hardware: <i>(not included w/binding post assembly)</i>
-102	210-0455-00			1					NUT, hex., 0.25-28 x 0.375 inch
-103	210-0223-00			1					LUG, solder, 0.25 ID x 0.438 inch OD, SE
-104	352-0084-00			2					HOLDER, neon, black
-105	352-0084-01			3					HOLDER, neon, white
-106	378-0541-00			4					FILTER, lens, white
-107	378-0541-01			1					FILTER, lens, green
-108	200-0609-00			5					COVER, neon holder
-109	131-0955-00			3					CONNECTOR, coaxial, BNC, w/hardware
	- - - - -			-					mounting hardware for each: <i>(not included w/connector)</i>
-110	210-0590-00			1					NUT, hex., 0.375-32 x 0.438 inch
-111	136-0223-00			1					SOCKET, light
	- - - - -			-					mounting hardware: <i>(not included w/socket)</i>
-112	210-0562-00			1					NUT, hex., 0.25-40 x 0.312 inch
-113	210-0223-00			1					LUG, solder, 0.25 ID x 0.438 inch OD, SE

FIGURE 1 FRONT & CRT SHIELD (cont)

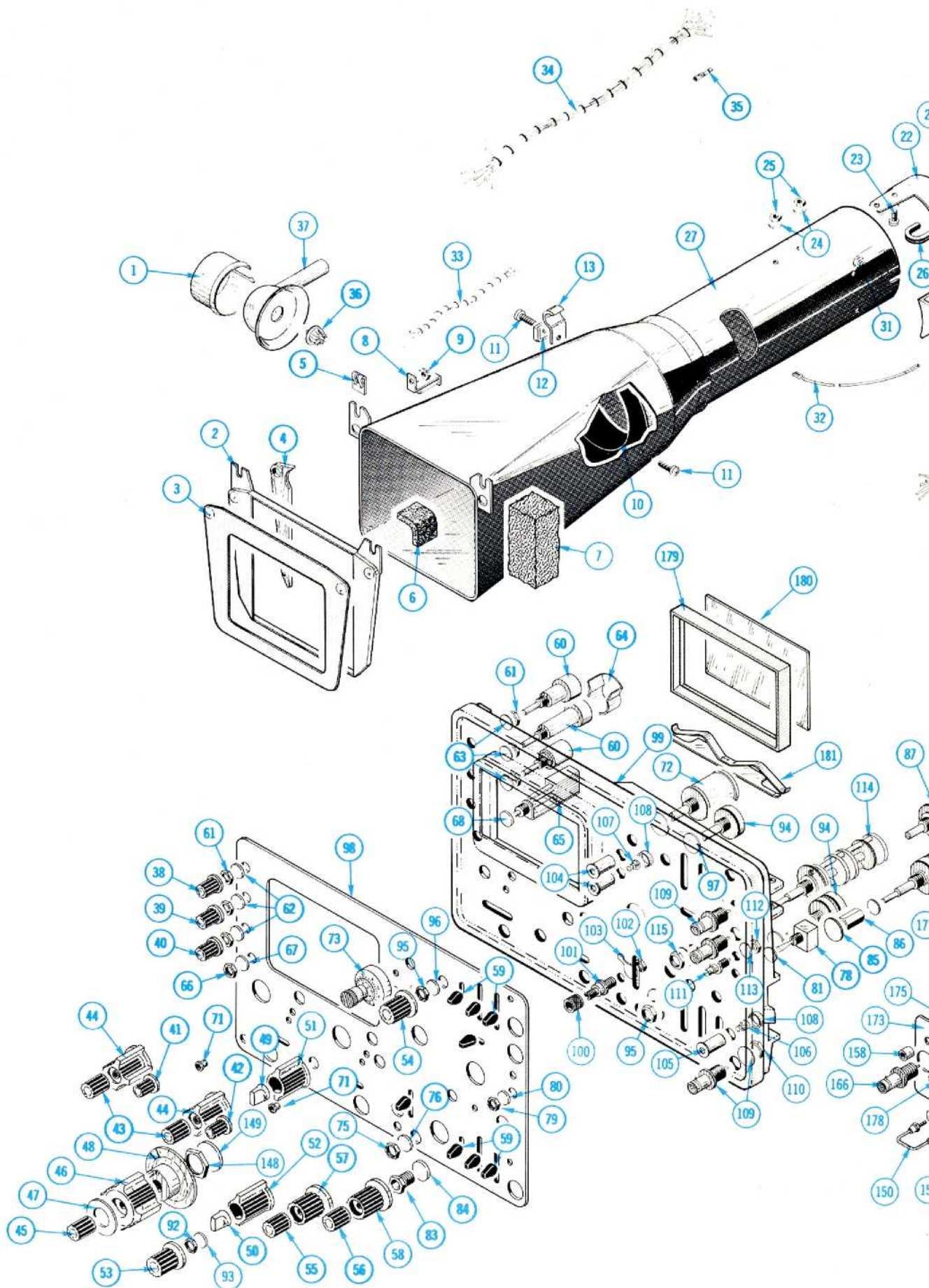
Fig. & Index No.	Tektronix Part No.	Serial/Model No.		Q t y	Description
		Eff	Disc		
1-114	262-0725-02			1	SWITCH, rotary—HORIZ DISPLAY, wired
	- - - - -			-	switch includes:
	260-1197-00	B010100	B059999	1	SWITCH, rotary, unwired
	260-1197-01	B060000		1	SWITCH, rotary, unwired
	179-0993-03			1	WIRING HARNESS, horizontal display A
	179-0994-03			1	WIRING HARNESS, horizontal display B
	- - - - -			-	mounting hardware: <i>(not included w/switch)</i>
-115	210-0590-00			1	NUT, hex., 0.375-32 x 0.438 inch
	210-0978-00			1	WASHER, flat, 0.375 ID x 0.50 inch OD
-116	260-0472-00			1	SWITCH, lever—SLOPE (A TRIGGERING)
	- - - - -			-	mounting hardware: <i>(not included w/switch)</i>
-117	220-0413-00			2	NUT, switch, 4-40 x 0.188 x 0.562 inch long
-118	260-0472-00			1	SWITCH, lever—SLOPE (B TRIGGERING)
	- - - - -			-	mounting hardware: <i>(not included w/switch)</i>
	220-0413-00			2	NUT, hex., 4-40 x 0.188 x 0.562 inch long
	262-0723-00			1	SWITCH, wired—COUPLING SOURCE (B TRIGGERING)
	- - - - -			-	switch includes:
-119	260-0700-00			1	SWITCH, lever—COUPLING
-120	260-0698-01			1	SWITCH, lever—SOURCE
-121	131-0371-00			2	CONNECTOR, terminal
	- - - - -			-	mounting hardware: <i>(not included w/switch)</i>
	220-0413-00			4	NUT, switch, 4-40 x 0.188 x 0.562 inch long
	262-0723-00			1	SWITCH, wired—COUPLING & SOURCE (A TRIGGERING)
	- - - - -			-	switch includes:
-122	260-0700-00			1	SWITCH, lever—COUPLING
-123	260-0698-01			1	SWITCH, lever—SOURCE
-124	131-0371-00			2	CONNECTOR, terminal
	- - - - -			-	mounting hardware: <i>(not included w/switch)</i>
	220-0413-00			4	NUT, switch, 4-40 x 0.188 x 0.562 inch long
-125	260-1149-00			1	SWITCH, lever—A SWEEP MODE
	- - - - -			-	mounting hardware: <i>(not included w/switch)</i>
	220-0413-00			2	NUT, switch, 4-40 x 0.188 x 0.562 inch long
-126	260-0587-00			1	SWITCH, lever—B SWEEP MODE
	- - - - -			-	mounting hardware: <i>(not included w/switch)</i>
	220-0413-00			2	NUT, switch, 4-40 x 0.188 x 0.562 inch long

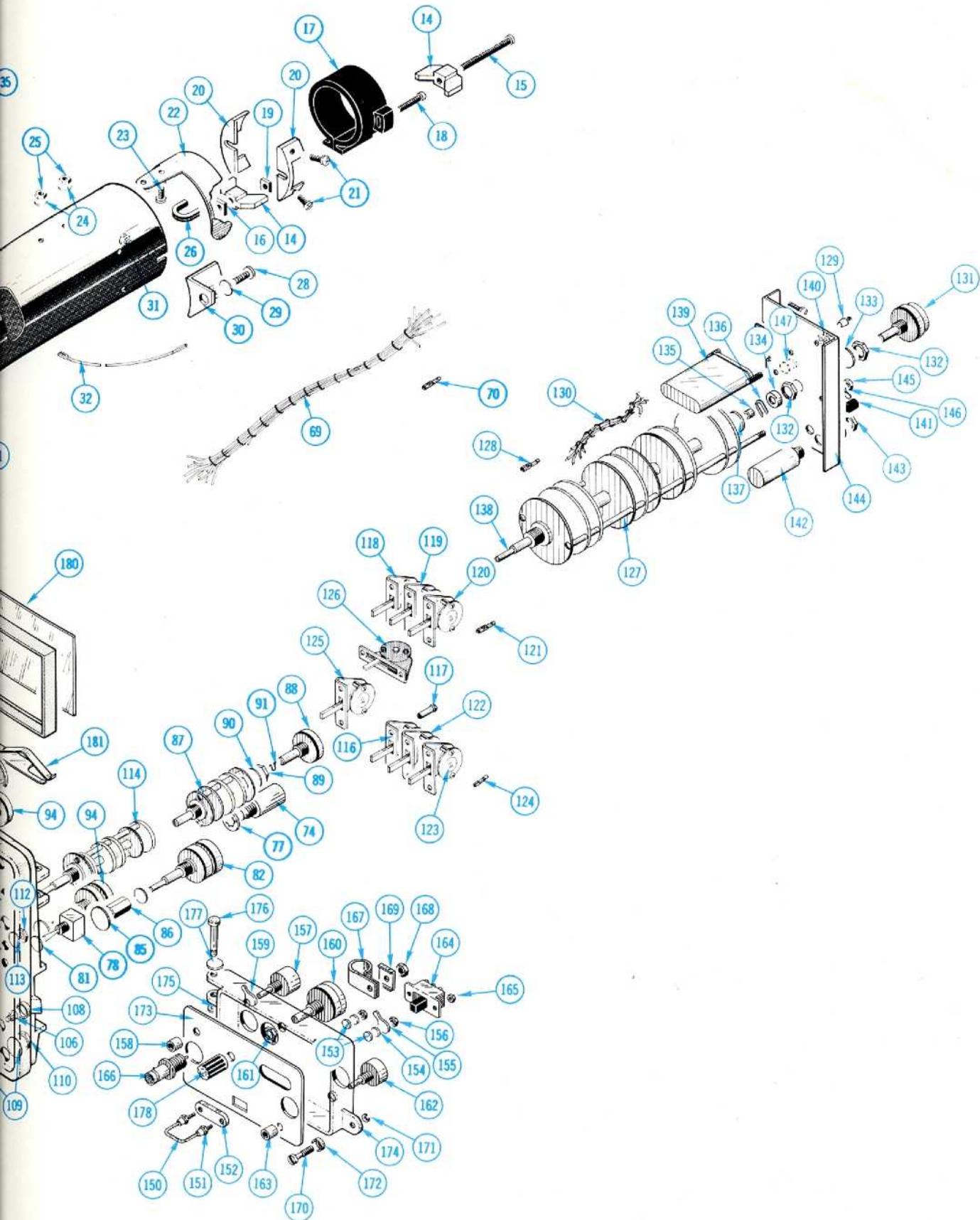
FIGURE 1 FRONT & CRT SHIELD (cont)

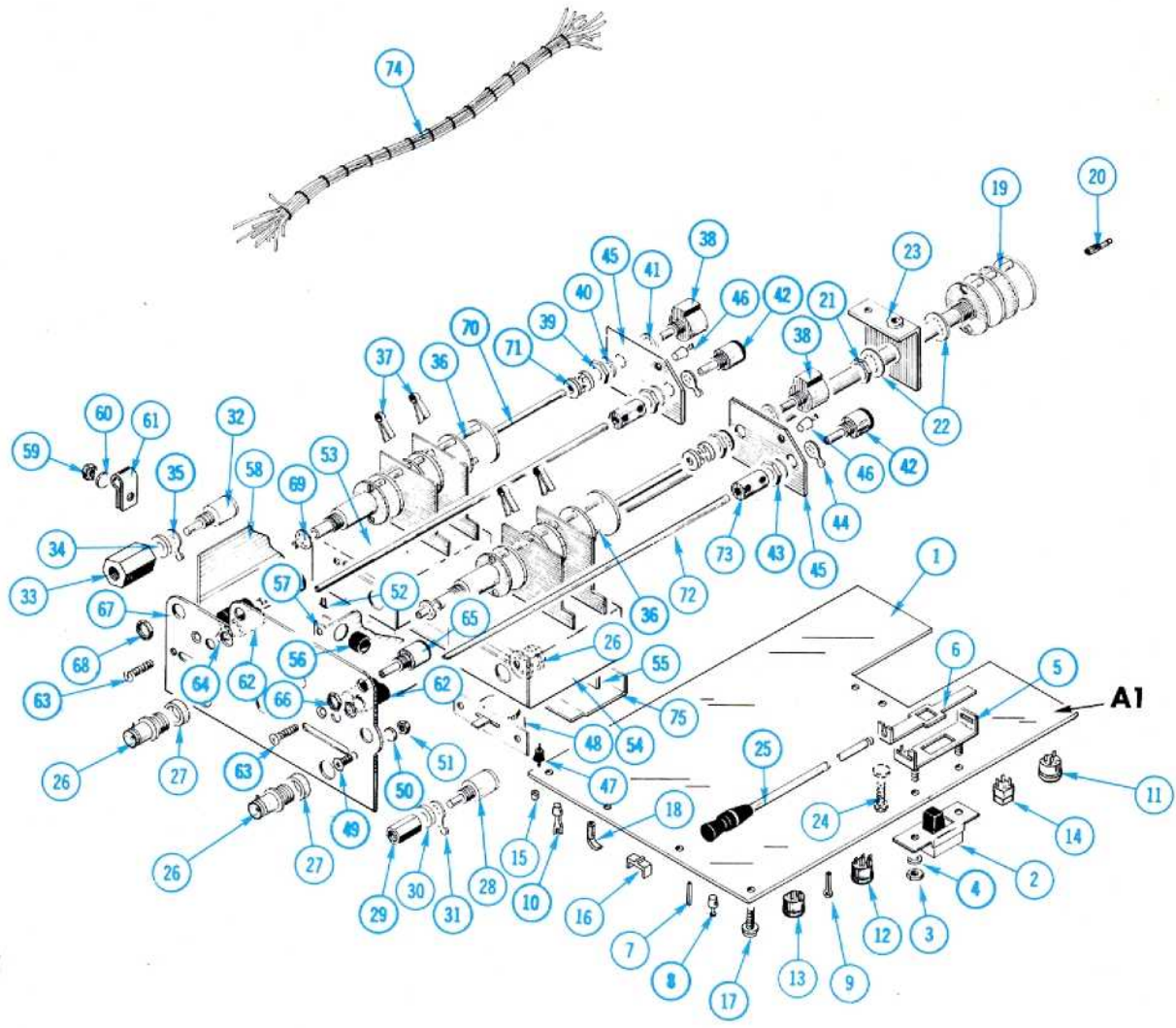
Fig. & Index No.	Tektronix Part No.	Serial/Model No. Eff	No. Disc	Q					Description	
				f	y	1	2	3		4
1-127	262-0724-01			1						SWITCH, rotary—A&B TIME/DIV & DELAY TIME, wired
	- - - - -			-						switch includes:
	260-0694-00			1						SWITCH, rotary, unwired
-128	131-0371-00			9						CONNECTOR, terminal
-129	131-0181-00			2						CONNECTOR, terminal standoff
	- - - - -			-						mounting hardware for each: <i>(not included w/connector)</i>
	358-0136-00			1						BUSHING, plastic
-130	179-1122-00			1						WIRING HARNESS, switch
-131	- - - - -			1						RESISTOR, variable
	- - - - -			-						mounting hardware: <i>(not included w/resistor)</i>
-132	210-0413-00			2						NUT, hex., 0.375-32 x 0.50 inch
-133	210-0012-00			1						WASHER, lock, internal, 0.375 ID x 0.50 inch OD
-134	361-0234-00			1						RESTRAINT, shaft coupling, 0.32 inch OD
-135	361-0233-00			1						RESTRAINT, shaft coupling, 0.188 inch OD
-136	376-0014-00			1						COUPLING, variable resistor
-137	210-0802-00			1						WASHER, flat, 0.151 ID x 0.312 inch OD
-138	384-0262-00			1						ROD, shaft extension, 7.563 inches long
-139	- - - - -			1						CAPACITOR
	- - - - -			-						mounting hardware: <i>(not included w/capacitor)</i>
-140	210-0457-00			2						NUT, keps, 6-32 x 0.312 inch
-141	348-0055-00			1						GROMMET, plastic, 0.25 inch diameter
-142	- - - - -			2						CAPACITOR
	- - - - -			-						mounting hardware for each: <i>(not included w/capacitor)</i>
-143	210-0524-00			1						NUT, hex., 0.312-24 x 0.50 inch
	210-0018-00			1						WASHER, lock, internal, 0.312 inch ID
-144	407-0148-00			1						BRACKET
	- - - - -			-						mounting hardware: <i>(not included w/bracket)</i>
-145	210-0449-00			2						NUT, hex., 5-40 x 0.25 inch
-146	210-0202-00			1						LUG, solder, SE#6
-147	210-0006-00			1						WASHER, lock, internal, 0.146 ID x 0.283 inch OD
	- - - - -			-						mounting hardware: <i>(not included w/switch)</i>
-148	210-0579-00			1						NUT, hex., 0.625-24 x 0.75 inch
-149	210-0049-00			1						WASHER, lock, internal, 0.625 inch ID
	211-0507-00			2						SCREW, 6-32 x 0.312 inch, PHS. <i>(not shown)</i>
-150	214-0335-00			1						BOLT, current loop
	- - - - -			-						mounting hardware: <i>(not included w/bolt)</i>
-151	210-0593-00			2						NUT, hex., current loop, 3-48 x 0.25 inch
-152	361-0059-00			1						SPACER
-153	210-0849-00			2						WASHER, fiber, shouldered
-154	210-0994-00			2						WASHER, flat, 0.125 ID x 0.25 inch OD
-155	210-0201-00			1						LUG, solder, SE #4
-156	210-0442-00			2						NUT, hex., 3-48 x 0.188 inch

FIGURE 1 FRONT & CRT SHIELD (cont)

Fig. & Index No.	Tektronix Part No.	Serial/Model Eff	No. Disc	Q					Description	
				t	y	1	2	3		4
1-157	- - - - -			1						RESISTOR, variable
				-						mounting hardware: (not included w/resistor)
-158	358-0075-00			1						BUSHING
-159	210-0223-00			1						LUG, solder, 0.25 inch, SE
-160	- - - - -			1						RESISTOR, variable
				-						mounting hardware: (not included w/resistor)
-161	210-0590-00			1						NUT, hex., 0.375-32 x 0.438 inch
	210-0012-00			1						WASHER, lock, internal, 0.375 ID x 0.50 inch OD
-162	- - - - -			1						RESISTOR, variable
				-						mounting hardware: (not included w/resistor)
-163	358-0075-00			1						BUSHING, 0.25-32 x 0.359 inch long
-164	260-0447-00			1						SWITCH, slide—CALIBRATOR
				-						mounting hardware: (not included w/switch)
-165	210-0406-00			2						NUT, hex., 4-40 x 0.188 inch
-166	131-0274-00			3						CONNECTOR, coaxial, BNC, w/hardware
-167	343-0005-00			1						CLAMP, cable, plastic, 0.438 inch
				-						mounting hardware: (not included w/clamp)
-168	210-0457-00			1						NUT, hex., 6-32 x 0.312 inch
-169	210-0863-00			1						WASHER, D-shape, 0.191 ID x 0.515 inch
-170	211-0598-00			1						SCREW, captive, 6-32 x 0.375 inch, Fil HS
				-						mounting hardware: (not included w/screw)
-171	354-0163-00			1						RING, retaining
-172	210-0869-00			1						WASHER, plastic, 0.156 ID x 0.375 inch OD
-173	333-0977-00			1						PANEL, front (calibrator chassis)
-174	426-0267-00			1						CHASSIS, calibrator
				-						mounting hardware: (not included w/chassis)
-175	354-0165-00			1						RING, retaining
-176	214-0573-00			1						PIN, hinge
-177	210-0805-00			1						WASHER, flat, 0.204 ID x 0.438 inch OD
-178	366-0236-00			1						KNOB, charcoal—B TIME/DIV
				-						knob includes:
	213-0020-00			1						SETSCREW, 6-32 x 0.125 inch, HSS
-179	354-0248-00			1						RING, ornamental
-180	378-0664-00			1						FILTER, light, CRT, 2.203 x 3.383 inches
-181	214-0996-00			1						SPRING, filter







453A/R453A OSCILLOSCOPE

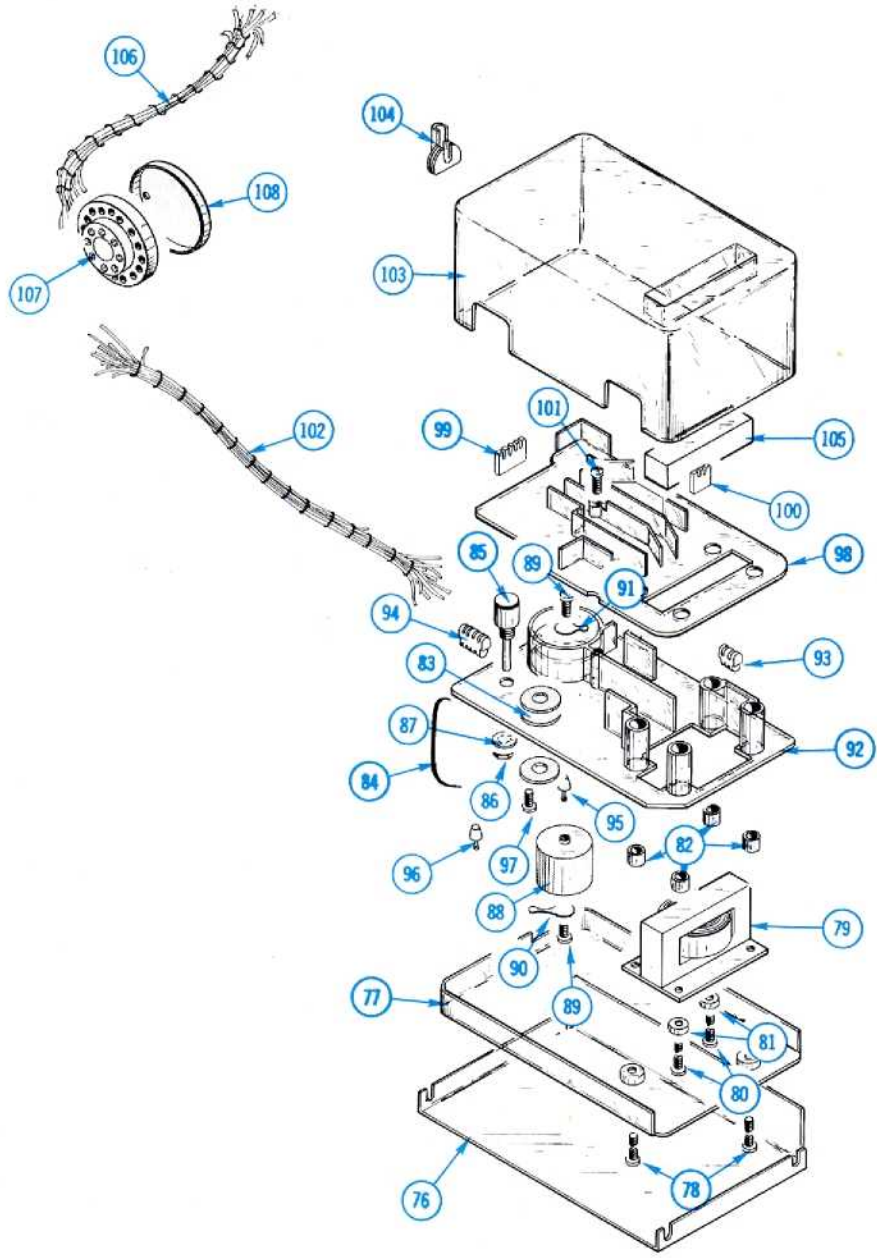


FIGURE 2 ATTENUATOR & HIGH VOLTAGE

Fig. & Index No.	Tektronix Part No.	Serial/Model Eff	No. Disc	Q					Description	
				†	Y	1	2	3		4
2-	644-0413-03			1						ATTENUATOR PREAMPLIFIER ASSEMBLY
	- - - - -			-						attenuator preamplifier assembly includes:
-1	670-0419-08	B010100	B109999	1						CIRCUIT BOARD ASSEMBLY—VERTICAL PREAMP A1
	670-1419-11	B110000		1						CIRCUIT BOARD ASSEMBLY—VERTICAL PREAMP A1
	- - - - -			-						circuit board assembly includes:
	388-0646-02			1						CIRCUIT BOARD
-2	260-0447-00			1						SWITCH, slide—INVERT
	- - - - -			-						mounting hardware: <i>(not included w/switch)</i>
-3	210-0406-00			2						NUT, hex., 4-40 x 0.188 inch
-4	210-0054-00			2						WASHER, lock, split, 0.118 ID x 0.212 inch OD
-5	406-0949-00			1						BRACKET
	- - - - -									
-6	214-0563-00			1						ACTUATOR, slide switch
-7	214-0506-00			31						PIN, connector
-8	131-0182-00			4						CONNECTOR, terminal, feed-thru
	- - - - -			-						mounting hardware for each: <i>(not included w/connector)</i>
	358-0135-00			1						BUSHING, plastic
	- - - - -									
	131-0344-00			2						CONNECTOR, terminal, feed-thru <i>(not shown)</i>
	- - - - -			-						mounting hardware for each: <i>(not included w/connector)</i>
	358-0241-00			1						BUSHING, plastic
	- - - - -									
-9	210-0579-00			8						PIN, test point
-10	131-0235-00			2						CONNECTOR, terminal
	- - - - -			-						mounting hardware for each: <i>(not included w/connector)</i>
	358-0135-00			1						BUSHING, plastic
	- - - - -									
-11	136-0235-01			2						SOCKET, transistor, 6 pin, plastic
-12	136-0235-00			2						SOCKET, transistor, 6 pin
-13	136-0183-00			2						SOCKET, transistor, 3 pin
-14	136-0220-00			14						SOCKET, transistor, 3 pin, square
-15	136-0261-00			6						SOCKET, connector pin
-16	200-0642-00			1						CAP
	- - - - -			-						mounting hardware: <i>(not included w/circuit board assembly)</i>
-17	211-0116-00			4						SCREW, sems, 4-40 x 0.312 inch, PHB
	- - - - -									
-18	343-0088-00			1						CLAMP, cable, plastic, small
-19	262-0727-01			1						SWITCH, rotary—MODE, wired
	- - - - -			-						switch includes:
	260-0695-01			1						SWITCH, rotary
-20	131-0371-00			8						CONNECTOR, terminal
-21	210-0413-00			1						NUT, hex., 0.375-32 x 0.50 inch
-22	210-0012-00			2						WASHER, lock, internal, 0.375 ID x 0.50 inch OD
-23	407-0157-00			1						BRACKET, switch
	- - - - -			-						mounting hardware: <i>(not included w/switch)</i>
-24	211-0116-00			1						SCREW, sems, 4-40 x 0.312 inch, PHB
	- - - - -									
-25	384-0789-01			1						ROD, extension, w/knob
-26	131-0955-00			2						CONNECTOR, coaxial, BNC, female, w/hardware
	- - - - -			-						mounting hardware for each: <i>(not included w/connector)</i>
-27	361-0348-00			1						SPACER

FIGURE 2 ATTENUATOR & HIGH VOLTAGE (cont)

Fig. & Index No.	Tektronix Part No.	Serial/Model Eff	No. Disc	Q					Description	
				t	y	1	2	3		4
2-28	- - - - -			1						RESISTOR, variable
	- - - - -			-						mounting hardware: <i>(not included w/resistor)</i>
-29	220-0510-00			1						NUT, hex., 0.25-32 x 0.312 x 0.40 inch long
-30	210-0940-00			1						WASHER, flat, 0.25 ID x 0.375 inch OD
-31	210-0223-00			1						LUG, solder, 0.25 ID x 0.438 inch OD, SE
-32	- - - - -			1						RESISTOR, variable
	- - - - -			-						mounting hardware: <i>(not included w/resistor)</i>
-33	220-0599-00			1						NUT, hex., 0.25-32 x 0.50 x 0.40 inch long
-34	210-0940-00			1						WASHER, flat, 0.25 ID x 0.375 inch OD
-35	210-0223-00			1						LUG, solder, 0.25 ID x 0.438 inch OD
-36	262-0728-03			2						SWITCH, rotary—VOLTS DIVISION, wired
	- - - - -			-						each switch includes:
	260-0720-03			1						SWITCH, rotary
-37	214-0599-00			2						SPRING, switch shaft ground
-38	- - - - -			1						RESISTOR, variable
	- - - - -			-						mounting hardware: <i>(not included w/resistor)</i>
-39	210-0583-00			1						NUT, hex., 0.25-32 x 0.312 inch
-40	210-0046-00			2						WASHER, lock, internal, 0.25 ID x 0.40 inch OD
-41	210-0223-00			1						LUG, solder, 0.25 ID x 0.438 inch OD, SE
-42	- - - - -			1						RESISTOR, variable
	- - - - -			-						mounting hardware: <i>(not included w/resistor)</i>
-43	210-0583-00			1						NUT, hex., 0.25-32 x 0.312 inch
-44	210-0223-00			1						LUG, solder, 0.25 ID x 0.438 inch OD, SE
-45	386-1284-00			1						PLATE, mounting, plastic
	- - - - -			-						mounting hardware: <i>(not included w/plate)</i>
	210-0405-00			2						NUT, hex., 2-56 x 0.188 inch
	210-0053-00			2						WASHER, lock, split, 0.092 ID x 0.175 inch OD
-46	131-0507-00			1						CONNECTOR, terminal, stand off
-47	131-0180-00			2						CONNECTOR, terminal
	- - - - -			-						mounting hardware: <i>(not included w/connector)</i>
	358-0135-00			1						BUSHING, plastic
-48	260-1168-00			2						SWITCH, lever—AC GND DC
	- - - - -			-						mounting hardware for each: <i>(not included w/switch)</i>
-49	211-0105-00			2						SCREW, 4-40 x 0.188 inch, 100° csk, FHS
-50	210-0004-00			2						WASHER, lock, internal, 0.12 ID x 0.26 inch OD
-51	210-0406-00			2						NUT, hex., 4-40 x 0.188 inch
-52	214-0456-00			8						FASTENER, press, plastic
-53	441-0964-00			1						CHASSIS, attenuator, left
-54	441-0968-00			1						CHASSIS, attenuator, right
-55	337-0769-00			2						SHIELD, attenuator
-56	348-0056-00			1						GROMMET, plastic, 0.375 inch diameter

FIGURE 2 ATTENUATOR & HIGH VOLTAGE (cont)

Fig. & Index No.	Tektronix Part No.	Serial/Model Eff	No. Disc	Q					Description	
				†	Y	1	2	3		4
2-57	337-1370-00			1						SHIELD, attenuator, center
	210-0586-00			-						mounting hardware: (not included w/shield)
	210-0201-00			4						NUT, keps, 4-40 x 0.25 inch (not shown)
				1						LUG, solder, SE #4 (not shown)
	337-1473-00	XB060000		1						SHIELD, electrical, high voltage, 1.50 x 1.135 inches
-58	337-1373-00			1						SHIELD, attenuator, side
				-						mounting hardware: (not included w/shield)
-59	210-0586-00			2						NUT, keps, 4-40 x 0.25 inch
-60	210-0851-00			1						WASHER, flat, 0.119 ID x 0.375 inch OD
-61	343-0001-00			1						CLAMP, cable, plastic, 0.125 inch diameter
-62	352-0067-00			2						HOLDER, neon, single
				-						mounting hardware for each: (not included w/holder)
-63	211-0109-00			1						SCREW, 4-40 x 0.875 inch, 100° csk, FHS
	210-0406-00			2						NUT, hex., 4-40 x 0.188 inch (not shown)
-64	378-0541-00			2						FILTER, lens, clear
-65				2						RESISTOR, variable
				-						mounting hardware for each: (not included w/resistor)
-66	210-0583-00			1						NUT, hex., 0.25-32 x 0.312 inch
-67	386-1868-00			1						PLATE, attenuator
				-						mounting hardware: (not included w/plate)
-68	210-0590-00			2						NUT, hex., 0.375-32 x 0.438 inch
-69	210-0012-00			2						WASHER, lock, internal, 0.375 ID x 0.50 inch OD
-70	384-0679-00			2						SHAFT, extension
-71	376-0050-00			2						COUPLING ASSEMBLY
				-						each coupling assembly includes:
	354-0251-00			2						RING, coupling
	376-0046-00			1						COUPLING, plastic
	213-0022-00			4						SETSCREW, 4-40 x 0.188 inch, HSS
-72	384-1049-00			2						ROD, extension
-73	376-0053-00			2						COUPLING, shaft
				-						each coupling includes:
	213-0048-00			2						SETSCREW, 4-40 x 0.125 inch, HSS
-74	179-0992-01			1						WIRING HARNESS, vertical preamp
				-						wiring harness includes:
	131-0371-00			11						CONNECTOR, terminal
				-						mounting hardware: (not included w/attenuator preamp assembly)
	211-0116-00			3						SCREW, sems, 4-40 x 0.312 inch, PHB (not shown)
	210-1001-00			3						WASHER, flat, 0.119 ID x 0.375 inch OD.(not shown)
	211-0097-00			1						SCREW, 4-40 x 0.312 inch, PHB.(not shown)
-75	337-0767-04			1						SHIELD, attenuator
				-						mounting hardware: (not included w/shield)
	211-0007-00			5						SCREW, 4-40 x 0.188 inch, PHS (not shown)

FIGURE 2 ATTENUATOR & HIGH VOLTAGE (cont)

Fig. & Index No.	Tektronix Part No.	Serial/Model Eff	No. Disc	Q					Description
				t	1	2	3	4	
2-76	337-0752-02			1					SHIELD, high voltage
	-----			-					mounting hardware: <i>(not included w/shield)</i>
	211-0503-00			3					SCREW, 6-32 x 0.188 inch, PHS <i>(not shown)</i>
-77	200-0708-00			1					COVER, plastic, high voltage
	-----			-					mounting hardware: <i>(not included w/cover)</i>
-78	211-0552-00			2					SCREW, 6-32 x 2 inches, PHS
	621-0452-00	B010100	B099999	1					HIGH VOLTAGE ASSEMBLY
	621-0452-01	B100000		1					HIGH VOLTAGE ASSEMBLY
	-----			-					high voltage assembly includes:
-79	-----			1					TRANSFORMER
	-----			-					mounting hardware: <i>(not included w/transformer)</i>
-80	211-0530-00			2					SCREW, 6-32 x 1.75 inches, PHS
-81	210-0869-00			2					WASHER, plastic, 0.156 ID x 0.375 inch OD
-82	358-0231-00			4					BUSHING, insulating
-83	210-0966-00			4					WASHER, insulating, 0.312 ID x 0.875 inch OD
-84	346-0032-00			1					STRAP, mouse tail
-85	-----			1					RESISTOR, variable
	-----			-					mounting hardware: <i>(not included w/resistor)</i>
-86	210-0583-00			1					NUT, hex., 0.25-32 x 0.312 inch
-87	210-0046-00			1					WASHER, lock, internal, 0.25 ID x 0.40 inch OD
-88	-----			1					CAPACITOR
	-----			-					mounting hardware: <i>(not included w/capacitor)</i>
-89	211-0503-00			2					SCREW, 6-32 x 0.188 inch, PHS
-90	210-0203-00			1					LUG, solder, SE #6, long
-91	210-0202-00			1					LUG, solder, SE #6
-92	441-0693-00			1					CHASSIS, high voltage, plastic
	-----			-					chassis includes:
-93	124-0163-00			6					TERMINAL STRIP, ceramic, 0.438 inch h, w/2 notches
-94	124-0164-00			4					TERMINAL STRIP, ceramic, 0.438 inch h, w/4 notches
-95	131-0227-00			2					CONNECTOR, terminal, stand-off
	-----			-					mounting hardware for each: <i>(not included w/connector)</i>
	358-0176-00			1					BUSHING, plastic
-96	131-0359-00			1					CONNECTOR, terminal, feed-thru
	-----			-					mounting hardware: <i>(not included w/connector)</i>
	358-0176-00			1					BUSHING, plastic
	-----			-					mounting hardware: <i>(not included w/chassis)</i>
-97	211-0558-00			1					SCREW, 6-32 x 0.25 inch, BH plastic
-98	392-0169-00			1					BOARD, high voltage, plastic
	-----			-					board includes:
-99	124-0176-00			2					TERMINAL STRIP, ceramic, 0.438 inch h, w/4 notches
-100	124-0175-00			4					TERMINAL STRIP, ceramic, 0.438 inch h, w/2 notches
	-----			-					mounting hardware: <i>(not included w/board)</i>
-101	211-0036-00			1					SCREW, 4-40 x 0.50 inch, BH plastic

FIGURE 2 ATTENUATOR & HIGH VOLTAGE (cont)

Fig. & Index No.	Tektronix Part No.	Serial/Model Eff	No. Disc	Q					Description	
				y	1	2	3	4		5
2-102	179-1580-00			1						WIRING HARNESS, high voltage #1
	179-1143-00			1						WIRING HARNESS, high voltage #2
-103	380-0108-00			1						HOUSING, high voltage, plastic
	- - - - -			-						mounting hardware: (not included w/high voltage assembly)
	211-0507-00			3						SCREW, 6-32 x 0.312 inch, PHS
-104	166-0368-00			1						SLEEVE, anode
-105	381-0243-00			1						BAR, heat sink
-106	136-0227-01			1						WIRING HARNESS, CRT socket
	- - - - -			-						wiring harness includes:
-107	136-0202-01			1						SOCKET, CRT, w/contacts
-108	200-0616-00			1						COVER, CRT socket

FIGURE 3 CHASSIS

Fig. & Index No.	Tektronix Part No.	Serial/Model No. Eff	No. Disc	Q † Y	Description				
					1	2	3	4	5
3-1	670-0417-02	B10100	B039999	1	CIRCUIT BOARD ASSEMBLY—A SWEEP A3				
	670-0417-05	B040000		1	CIRCUIT BOARD ASSEMBLY—A SWEEP A3				
	- - - - -			-	circuit board assembly includes:				
	388-0644-02	B010100	B039999	1	CIRCUIT BOARD				
	388-0644-04	B040000		1	CIRCUIT BOARD				
-2	136-0220-00			26	SOCKET, transistor, 3 pin, square				
-3	136-0183-00			1	SOCKET, transistor, 3 pin				
-4	214-0506-00			47	PIN, connector				
-5	214-0579-00			8	PIN, test point				
-6	214-0565-00			2	FASTENER, pin press				
-7	337-0762-00			1	SHIELD, electrical				
-8	343-0043-00			1	CLAMP, neon bulb				
	- - - - -			-	mounting hardware: (not included w/circuit board assembly)				
-9	211-0116-00			6	SCREW, sems, 6-32 x 0.312 inch, PHB				
	337-1339-00	XB040000		1	SHIELD, electrical, A sweep (not shown)				
	- - - - -			-	mounting hardware: (not included w/shield)				
	213-0055-01	XB040000		4	SCREW, thread forming, 2-32 x 0.188 inch, PHS				
-10	343-0088-00			2	CLAMP, cable, plastic, small				
-11	343-0089-00			7	CLAMP, cable, plastic, large				
-12	670-0418-05			1	CIRCUIT BOARD ASSEMBLY—B SWEEP A4				
	- - - - -			-	circuit board assembly includes:				
	388-0645-05			1	CIRCUIT BOARD				
-13	136-0220-00			25	SOCKET, transistor, 3 pin, square				
-14	136-0235-00			1	SOCKET, transistor, 6 pin				
-15	136-0183-00			2	SOCKET, transistor, 3 pin				
-16	214-0506-00			49	PIN, connector				
-17	214-0579-00			6	PIN, test point				
-18	214-0565-00			1	FASTENER, pin press				
-19	210-1014-00			1	WASHER, plastic, 0.094 ID x 0.312 inch OD				
-20	337-0763-00			1	SHIELD, electrical				
	- - - - -			-	mounting hardware: (not included w/circuit board assembly)				
-21	211-0116-00			6	SCREW, sems, 4-40 x 0.312 inch, PHB				
-22	407-0144-00			1	BRACKET, capacitor				
	- - - - -			-	mounting hardware: (not included w/bracket)				
-23	211-0504-00			4	SCREW, 6-32 x 0.25 inch, PHS				
-24	344-0140-00	B010100	B099999X	1	CLIP, capacitor mounting				
	- - - - -			-	mounting hardware: (not included w/clip)				
-25	211-0008-00	B010100	B099999X	1	SCREW, 4-40 x 0.25 inch, PHS				
-26	210-0586-00	B010100	B099999X	1	NUT, keps, 4-40 x 0.25 inch				
-27	200-0256-00	B010100	B099999	2	COVER, capacitor, 1 ID x 2.031 inches long				
	200-0533-00	B100000		2	COVER, capacitor, 1 ID x 0.75 inch long				
-28	200-0532-00			2	COVER, capacitor, 0.99 ID x 1.594 inches long				
-29	- - - - -			4	CAPACITOR				
	- - - - -			-	mounting hardware for each: (not included w/capacitor)				
-30	211-0588-00			2	SCREW, 6-32 x 0.75 inch, HHS				
-31	432-0047-00			1	BASE, capacitor, plastic				
-32	386-0252-00			1	PLATE, fiber, small				
-33	210-0457-00			2	NUT, keps, 6-32 x 0.312 inch				

FIGURE 3 CHASSIS (cont)

Fig. & Index No.	Tektronix Part No.	Serial/Model Eff	No. Disc	Q					Description
				y	1	2	3	4	
3-34	124-0146-00			4					TERMINAL STRIP, ceramic, 0.438 inch h, w/16 notches
	- - - - -			-					each terminal strip includes:
	355-0046-00			2					STUD, plastic
	- - - - -			-					mounting hardware for each: <i>(not included w/terminal strip)</i>
	361-0007-00			2					SPACER, 0.156 inch long
-35	407-0150-00			1					BRACKET, outer support
	- - - - -			-					bracket, includes
-36	252-0571-00			ft					NEOPRENE, extruded, 0.208 foot long
	- - - - -			-					mounting hardware: <i>(not included w/bracket)</i>
	211-0504-00			2					SCREW, 4-40 x 0.25 inch, PHS <i>(not shown)</i>
-37	386-1268-00			1					SUPPORT, chassis
	- - - - -			-					mounting hardware: <i>(not included w/support)</i>
	212-0001-00			1					SCREW, 8-32 x 0.25 inch, PHS
-38	210-0457-00			1					NUT, keps, 6-32 x 0.312 inch
-39	211-0504-00			1					SCREW, 6-32 x 0.25 inch, PHS
-40	210-0201-00			1					LUG, solder, SE #4
	- - - - -			-					mounting hardware: <i>(not included w/lug)</i>
-41	213-0044-00			1					SCREW, thread forming, 5-40 x 0.312 inch, PHS
-42	210-0201-00			1					LUG, solder, SE #4
	- - - - -			-					mounting hardware: <i>(not included w/lug)</i>
-43	210-0586-00			1					NUT, keps, 4-40 x 0.25 inch
-44	343-0097-00			2					CLAMP, transistor
	- - - - -			-					mounting hardware for each: <i>(not included w/clamp)</i>
-45	210-0599-00			2					NUT, sleeve
-46	214-0368-00			1					SPRING, helical compression
-47	210-0004-00			2					WASHER, lock, internal, 0.12 ID x 0.26 inch OD
-48	210-0627-00			2					RIVET
-49	214-1138-00			2					HEAT SINK
	- - - - -			-					mounting hardware for each: <i>(not included w/heat sink)</i>
-50	211-0012-00			2					SCREW, 4-40 x 0.375 inch, PHS
-51	210-0004-00			2					WASHER, lock, internal, 0.12 ID x 0.26 inch OD
-52	211-0033-00			2					SCREW, sems, 4-40 x 0.312 inch, PHS
-53	352-0062-00			1					HOLDER, heat sink
-54	210-0406-00			4					NUT, hex., 4-40 x 0.188 inch

FIGURE 3 CHASSIS (cont)

Fig. & Index No.	Tektronix Part No.	Serial/Model No.		Q	Description
		Eff	Disc		
				t	
				y	1 2 3 4 5
3-55	124-0148-00			2	TERMINAL STRIP, ceramic, 0.438 inch h, w/9 notches
	- - - - -			-	each terminal strip includes:
	355-0046-00			2	STUD, plastic
	- - - - -			-	mounting hardware for each: <i>(not included w/terminal strip)</i>
	361-0007-00			2	SPACER, 0.156 inch
	119-0168-01			1	DELAY LINE ASSEMBLY
	- - - - -			-	delay line assembly includes:
	119-0168-00			1	DELAY LINE
	- - - - -			-	mounting hardware: <i>(not included w/delay line)</i>
-56	211-0578-00			2	SCREW, 6-32 x 0.438 inch, PHS
-57	343-0259-00			1	CLAMP, delay line
-58	210-0204-00			1	LUG, solder, DE #6
	- - - - -			-	mounting hardware: <i>(not included w/lug)</i>
-59	211-0504-00			1	SCREW, 6-32 x 0.25 inch, PHS
-60	407-0480-00			1	BRACKET, delay line
	- - - - -			-	mounting hardware: <i>(not included w/delay line assembly)</i>
	211-0504-00			2	SCREW, 6-32 x 0.25 inch, PHS <i>(not shown)</i>
-61	210-0457-00			1	NUT, keps, 6-32 x 0.312 inch
-62	211-0097-00			1	SCREW, 4-40 x 0.312 inch, PHS
-63	- - - - -			1	CAPACITOR
	- - - - -			-	mounting hardware: <i>(not included w/capacitor)</i>
-64	210-0507-00	B010100	B069999	2	NUT, hex., 6-32 x 0.25 inch
-65	210-0006-00	B010100	B069999	2	WASHER, lock, internal, 0.146 ID x 0.283 inch OD
	210-0457-00	B070000		2	NUT, keps, 6-32 x 0.312 inch
	131-0022-00	B070000		2	CONNECTOR, terminal, tie point, 1 point
-66	343-0013-00			4	CLAMP, cable, 0.375 inch diameter
	- - - - -			-	mounting hardware for each: <i>(not included w/clamp)</i>
-67	210-0457-00			1	NUT, keps, 6-32 x 0.312 inch
-68	210-0863-00			1	WASHER, D-shape, 0.191 ID x 0.515 inch
-69	202-0142-01			1	BOX, high voltage
	- - - - -			-	mounting hardware: <i>(not included w/box)</i>
-70	211-0504-00			6	SCREW, 6-32 x 0.25 inch, PHS
-71	358-0215-00			2	BUSHING, plastic
-72	348-0055-00			1	GROMMET, plastic, 0.25 inch diameter
-73	348-0056-00			2	GROMMET, plastic, 0.406 inch diameter
-74	348-0064-00			2	GROMMET, plastic, 0.625 inch diameter
-75	343-0002-00			1	CLAMP, cable, plastic, 0.188 inch diameter
	- - - - -			-	mounting hardware: <i>(not included w/clamp)</i>
-76	210-0457-00			1	NUT, hex., 6-32 x 0.312 inch
-77	210-0863-00			1	WASHER, D-shape, 0.191 ID x 0.515 inch OD

FIGURE 3 CHASSIS (cont)

Fig. & Index No.	Tektronix Part No.	Serial/Model No. Eff	No. Disc	Q					Description
				†	1	2	3	4	
3-78	343-0097-00			2					CLAMP, transistor
	- - - - -			-					mounting hardware for each: <i>(not included w/clamp)</i>
-79	210-0599-00			2					NUT, sleeve
-80	214-0368-00			1					SPRING, helical compression
-81	210-0004-00			2					WASHER, lock, internal, 0.12 ID x 0.26 inch OD
-82	210-0627-00			2					RIVET
-83	214-0317-00			2					HEAT SINK
	- - - - -			-					mounting hardware for each: <i>(not included w/heat sink)</i>
-84	211-0033-00			2					SCREW, sems, 4-40 x 0.312 inch, PHS
-85	211-0012-00			2					SCREW, 4-40 x 0.375 inch, PHS
-86	210-0004-00			2					WASHER, lock, internal, 0.12 ID x 0.26 inch OD
-87	210-0046-00			4					NUT, hex., 4-40 x 0.188 inch
-88	386-0202-01			1					PLATE, center bulkhead
-89	129-0069-00			3					POST, terminal, tie off
	- - - - -			-					mounting hardware for each: <i>(not included w/post)</i>
	361-0007-00			1					SPACER, plastic, 0.156 inch
-90	131-0181-00			1					CONNECTOR, terminal, standoff
	- - - - -			-					mounting hardware: <i>(not included w/connector)</i>
	358-0136-00			1					BUSHING, plastic
-91	210-0201-00			1					LUG, solder, SE #4
	- - - - -			-					mounting hardware: <i>(not included w/lug)</i>
-92	213-0044-00			1					SCREW, thread forming, 5-32 x 0.188 inch
-93	670-0414-07	B010100	B079999	1					CIRCUIT BOARD ASSEMBLY—Z AXIS A5
	670-0414-06	B080000		1					CIRCUIT BOARD ASSEMBLY—Z AXIS A5
	- - - - -			-					circuit board assembly includes:
	388-0641-02	B010100	B079999	1					CIRCUIT BOARD
	388-0641-05	B080000		1					CIRCUIT BOARD
-94	214-0506-00			20					PIN, connector
-95	214-0579-00			3					PIN, test point
-96	136-0183-00	B010100	B079999	4					SOCKET, transistor, 3 pin
	136-0183-00	B080000		5					SOCKET, transistor, 3 pin
-97	136-0220-00	B010100	B079999	4					SOCKET, transistor, 3 pin, square
	136-0220-00	B080000		3					SOCKET, transistor, 3 pin, square
	- - - - -			-					mounting hardware: <i>(not included w/circuit board assembly)</i>
-98	211-0116-00			3					SCREW, sems, 4-40 x 0.312 inch, PHB
-99	- - - - -			1					TRANSFORMER
	- - - - -			-					transformer includes:
-100	407-0741-00			1					BRACKET, component mounting
-101	343-0267-00			2					HOLD-DOWN, bracket
-102	212-0099-00			4					SCREW, 8-32 x 0.50 inch, HHS
-103	210-0409-00	B010100	B041229	4					NUT, hex., 8-32 x 0.312 inch
	210-0458-00	B041230		4					NUT, keps, 8-32 x 0.344 inch
	- - - - -			-					mounting hardware: <i>(not included w/transformer)</i>
-104	212-0001-00			4					SCREW, 8-32 x 0.25 inch, PHS

FIGURE 3 CHASSIS (cont)

Fig. & Index No.	Tektronix Part No.	Serial/Model No.		Q † y	Description
		Eff	Disc		
3-105	255-0334-00			ft	PLASTIC CHANNEL, 1 inch long
-106	352-0031-00			2	HOLDER, fuse, single
	- - - - -			-	mounting hardware for each: <i>(not included w/holder)</i>
-107	210-0406-00			1	NUT, hex., 4-40 x 0.188 inch
-108	210-0054-00			1	WASHER, lock, split, 0.118 ID x 0.212 inch OD
-109	343-0088-00			6	CLAMP, cable, plastic, small
-110	670-0415-00			1	CIRCUIT BOARD ASSEMBLY—LOW VOLTAGE REG. A6
	- - - - -			-	circuit board assembly includes:
	388-0642-01			1	CIRCUIT BOARD
-111	214-0506-00			21	PIN, connector
-112	136-0183-00			4	SOCKET, transistor, 3 pin
-113	136-0220-00			4	SOCKET, transistor, 3 pin, square
	- - - - -			-	mounting hardware: <i>(not included w/circuit board assembly)</i>
-114	211-0036-00			3	SCREW, 4-40 x 0.50 inch, BH plastic
-115	214-0781-01			3	INSULATOR, plastic
-116	407-0143-00			1	BRACKET, regulator
	- - - - -			-	mounting hardware: <i>(not included w/bracket)</i>
-117	211-0504-00			3	SCREW, 6-32 x 0.25 inch, PHS
	210-0802-00			1	WASHER, flat, 0.15 ID x 0.312 inch OD
-118	214-0289-00			2	HEAT SINK, transistor
	- - - - -			-	mounting hardware: <i>(not included w/heat sink)</i>
-119	220-0410-00			1	NUT, keps, 10-32 x 0.375 inch
-120	348-0056-00			1	GROMMET, plastic, 0.406 inch diameter
-121	- - - - -			2	RESISTOR
	- - - - -			-	mounting hardware for each: <i>(not included w/resistor)</i>
-122	211-0507-00			1	SCREW, 6-32 x 0.312 inch, PHS
-123	211-0553-00			1	SCREW, 6-32 x 1.50 inches, RHS
-124	210-0601-00			1	EYELET
-125	210-0478-00			1	NUT, hex., 0.312 x 0.656 inch long
-126	- - - - -			3	TRANSISTOR
	- - - - -			-	mounting hardware for each: <i>(not included w/transistor)</i>
-127	211-0510-00			2	SCREW, 6-32 x 0.375 inch, PHS
-128	387-0345-00			1	PLATE, insulator
-129	210-0811-00			2	WASHER, fiber, shouldered, #6
-130	210-0802-00			2	WASHER, flat, 0.15 ID x 0.312 inch OD
-131	210-0202-00			1	LUG, solder, SE #6
-132	210-0006-00			1	WASHER, lock, internal, 0.146 ID x 0.283 inch OD
-133	210-0407-00			2	NUT, hex., 6-32 x 0.25 inch

FIGURE 3 CHASSIS (cont)

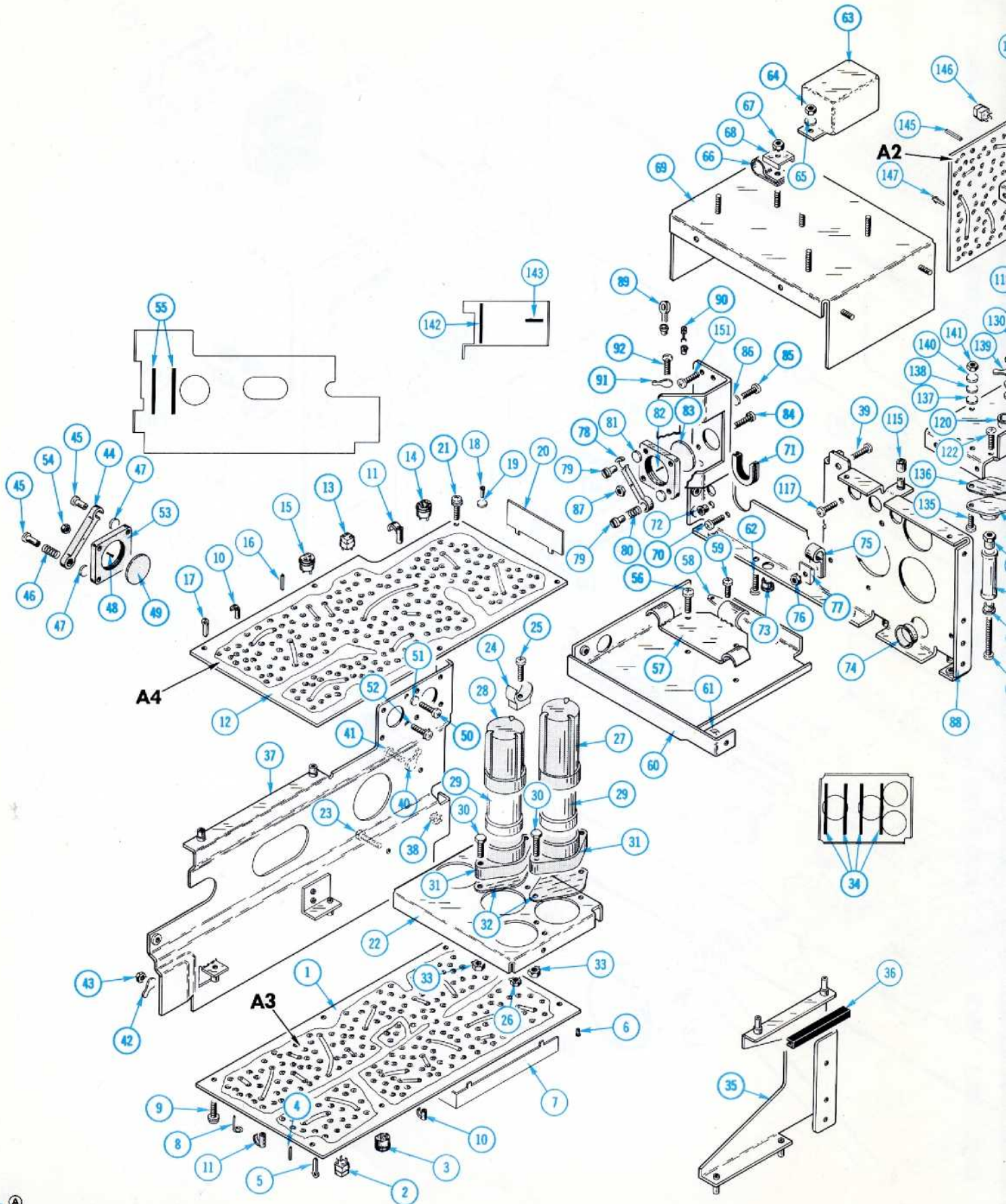
Fig. & Index No.	Tektronix Part No.	Serial/Model No.		Q	Description
		Eff	Disc		
				t	
				y	1 2 3 4 5
3-134	- - - - -			1	TRANSISTOR
	- - - - -			-	mounting hardware: <i>(not included w/transistor)</i>
-135	211-0510-00			2	SCREW, 6-32 x 0.375 inch, PHS
-136	386-0143-00			1	PLATE, mica, insulator
-137	210-0983-00			2	WASHER, fiber, shouldered
-138	210-0802-00			2	WASHER, flat, 0.15 ID x 0.312 inch OD
-139	210-0202-00			1	LUG, solder, SE #6
-140	210-0006-00			1	WASHER, lock, internal, 0.146 ID x 283 inch OD
-141	210-0407-00			2	NUT, hex., 6-32 x 0.25 inch
-142	124-0147-00			1	TERMINAL STRIP, ceramic, 0.438 inch h, w/13 notches
	- - - - -			-	terminal strip includes:
	355-0046-00			2	STUD, plastic
	- - - - -			-	mounting hardware: <i>(not included w/terminal strip)</i>
	361-0007-00			2	SPACER, plastic, 0.156 inch
-143	124-0119-00			1	TERMINAL STRIP, ceramic, 0.438 inch h, w/2 notches
	- - - - -			-	terminal strip includes:
	355-0046-00			1	STUD, plastic
	- - - - -			-	mounting hardware: <i>(not included w/terminal strip)</i>
	361-0007-00			1	SPACER, plastic, 0.156 inch
-144	670-0416-02	B010100	B049999	1	CIRCUIT BOARD ASSEMBLY—VERTICAL OUTPUT A2
	670-0416-04	B050000		1	CIRCUIT BOARD ASSEMBLY—VERTICAL OUTPUT A2
	- - - - -			-	circuit board assembly includes:
	388-0643-01	B010100	B049999	1	CIRCUIT BOARD
	388-0643-03	B050000		1	CIRCUIT BOARD
-145	214-0506-00			6	PIN, connector
-146	136-0220-00			6	SOCKET, transistor, 3 pin, square
-147	344-0119-00			4	CLIP, electrical
	- - - - -			-	mounting hardware: <i>(not included w/assembly)</i>
-148	211-0116-00			4	SCREW, sems, 4-40 x 0.312 inch, PHB
-149	407-0147-00			1	BRACKET, circuit board, 4.062 inches long
	- - - - -			-	mounting hardware: <i>(not included w/bracket)</i>
-150	211-0504-00			1	SCREW, 6-32 x 0.25 inch, PHS
-151	211-0008-00			2	SCREW, 4-40 x 0.25 inch, PHS
-152	407-0146-00			1	BRACKET, circuit board, 3.50 inches long
	- - - - -			-	mounting hardware: <i>(not included w/bracket)</i>
-153	210-0457-00			2	NUT, keps, 6-32 x 0.312 inch
-154	441-0719-00			1	CHASSIS, rear
-155	369-0025-00			1	IMPELLER, fan
	- - - - -			-	impeller includes:
	213-0126-00			1	SETSCREW, 6-32 x 0.25 inch, HSS

FIGURE 3 CHASSIS (cont)

Fig. & Index No.	Tektronix Part No.	Serial/Model No.		Q	Description
		Eff	Disc		
				t	
				y	1 2 3 4 5
3-156	407-0308-02			1	BRACKET, fan motor
	- - - - -			-	mounting hardware: (not included w/bracket)
-157	211-0012-00			3	SCREW, 4-40 x 0.375 inch, PHS
-158	210-0851-00			6	WASHER, flat, 0.119 ID x 0.375 inch OD
-159	348-0093-00			3	GROMMET, rubber, 0.14 ID x 0.375 inch OD
-160	220-0471-00			3	NUT, stepped, round, 4-40 x 0.217 inch long
-161	147-0027-00	B010100	B089999	1	MOTOR, fan
	147-0033-01	B090000	- 50 → 60 Hz	1	MOTOR, fan
	- - - - -			-	mounting hardware: (not included w/motor)
-162	211-0097-00	B010100	B089999	3	SCREW, 4-40 x 0.312 inch, PHS
	211-0158-00	B090000		3	SCREW, 4-40 x 0.25 inch, PHS
	210-0054-00	B010100	B089999	3	WASHER, lock, split, 0.118 ID x 0.212 inch OD
	210-0004-00	B090000		3	WASHER, lock, internal, 012 ID x 0.26 inch OD
-163	131-0759-00			1	TERMINAL, lug
-164	380-0114-00	B010100	B089999X	1	HOUSING, air flow
	337-1505-00	XB090000		1	SHIELD, fan motor
-165	348-0063-00			5	GROMMET, plastic, 0.50 inch diameter
-166	348-0064-00			2	GROMMET, plastic, 0.625 inch diameter
-167	- - - - -			1	THERMO CUTOUT
	- - - - -			-	mounting hardware: (not included w/thermo cutout)
-168	213-0044-00			2	SCREW, thread forming, 5-32 x 0.188 inch, PHS
-169	214-0210-00			1	SOLDER SPOOL ASSEMBLY
	- - - - -			-	solder spool assembly includes:
	214-0209-00			1	SPOOL, solder
	- - - - -			-	mounting hardware: (not included w/solder spool assembly)
-170	361-0007-00			1	SPACER, plastic, 0.156 inch
-171	210-0202-00			2	LUG, solder, SE #6
	- - - - -			-	mounting hardware for each: (not included w/lug)
-172	213-0044-00			1	SCREW, thread forming, 5-32 x 0.188 inch, PHS
-173	352-0031-00			1	HOLDER, fuse, single
	- - - - -			-	mounting hardware: (not included w/holder)
-174	211-0507-00			1	SCREW, 6-32 x 0.312 inch, PHS
-175	- - - - -			1	RESISTOR, variable
	- - - - -			-	mounting hardware: (not included w/resistor)
-176	210-0538-00			1	NUT, hex., 0.25-32 x 0.312 inch
-177	210-0940-00			1	WASHER, flat, 0.25 ID x 0.375 inch OD
-178	210-0223-00			1	LUG, solder, 0.25 ID x 0.438 inch OD, SE

FIGURE 3 CHASSIS (cont)

Fig. & Index No.	Tektronix Part No.	Serial/Model Eff	No. Disc	Q					Description	
				t	y	1	2	3		4
3-179	124-0145-00			2						TERMINAL STRIP, ceramic, 0.438 inch h, w/20 notches
	- - - - -			-						each terminal strip includes:
	355-0046-00			2						STUD, plastic
	- - - - -			-						mounting hardware for each: (not included w/terminal strip)
	361-0007-00			2						SPACER, plastic, 0.156 inch
-180	124-0147-00			1						TERMINAL STRIP, ceramic, 0.438 inch h, w/13 notches
	- - - - -			-						terminal strip includes:
	355-0046-00			2						STUD, plastic
	- - - - -			-						mounting hardware: (not included w/terminal strip)
	361-0007-00			2						SPACER, plastic, 0.156 inch
-181	179-0995-02			1						WIRING HARNESS, A sweep
	- - - - -			-						wiring harness includes:
-182	131-0371-00			37						CONNECTOR, terminal
	179-0991-01			1						WIRING HARNESS, regulator bracket
	179-0990-02			1						WIRING HARNESS, capacitor bracket
	- - - - -			-						wiring harness includes:
	131-0371-00			3						CONNECTOR, terminal



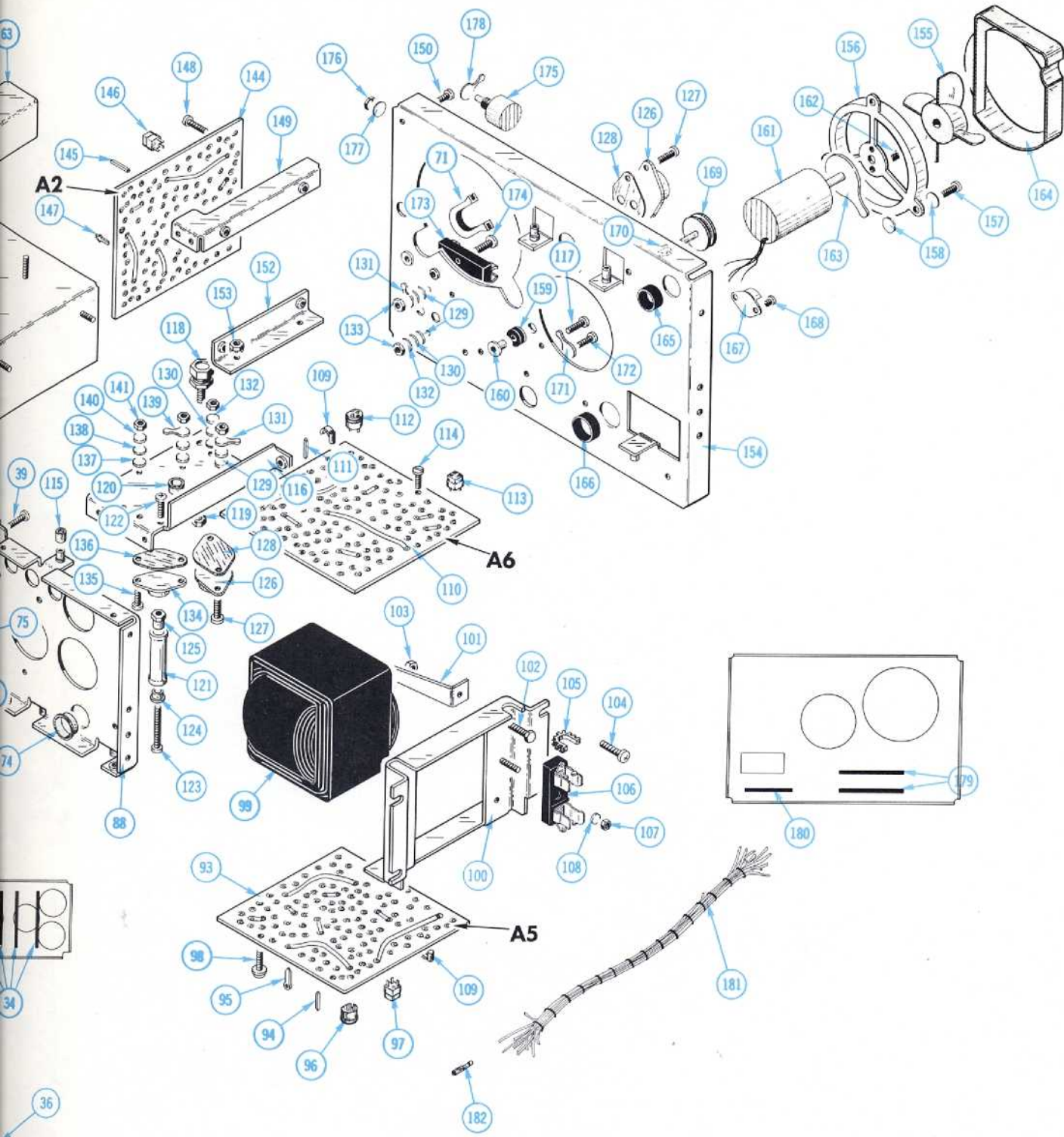
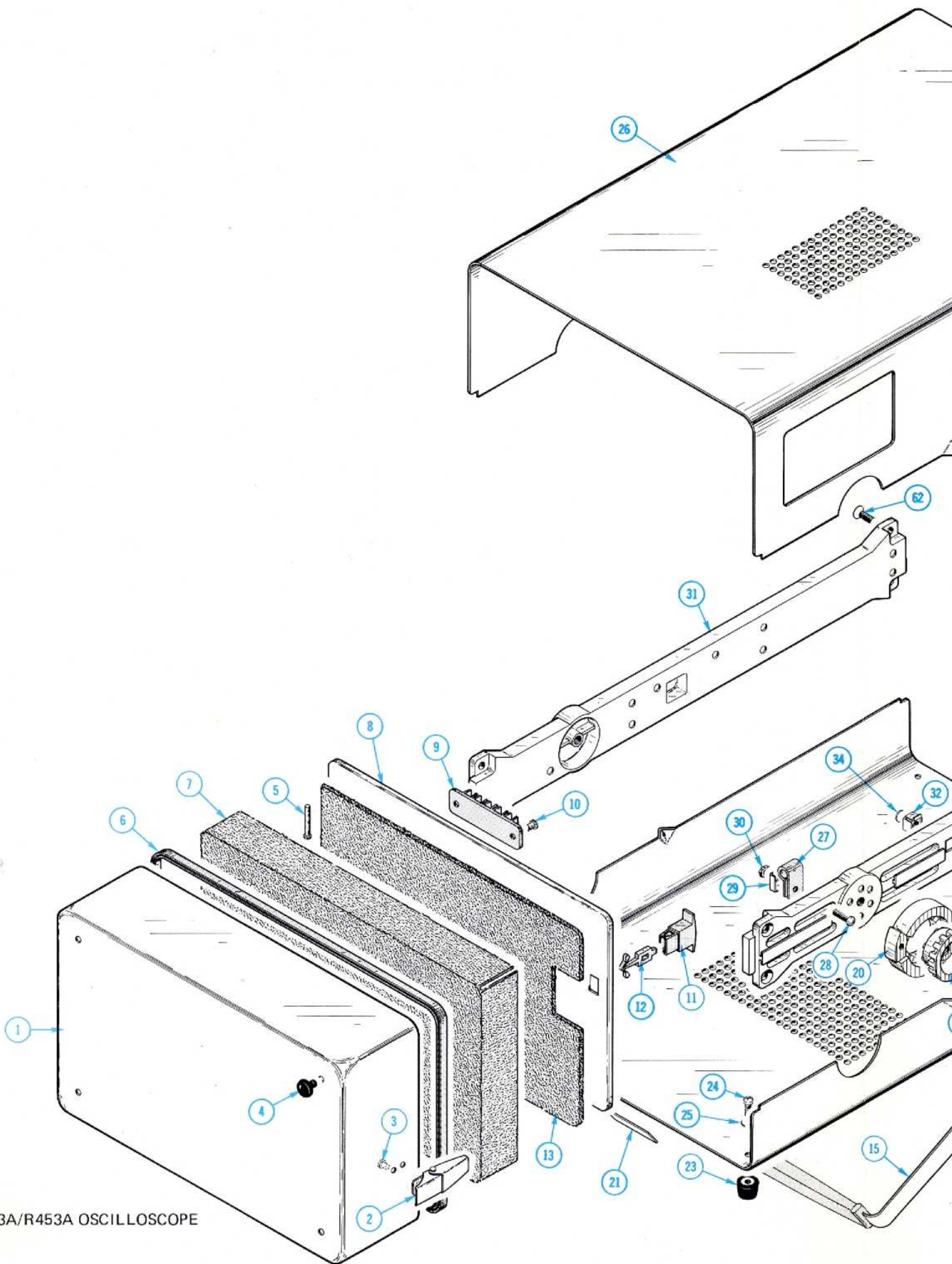


FIG. 3 CHASSIS

+



453A/R453A OSCILLOSCOPE

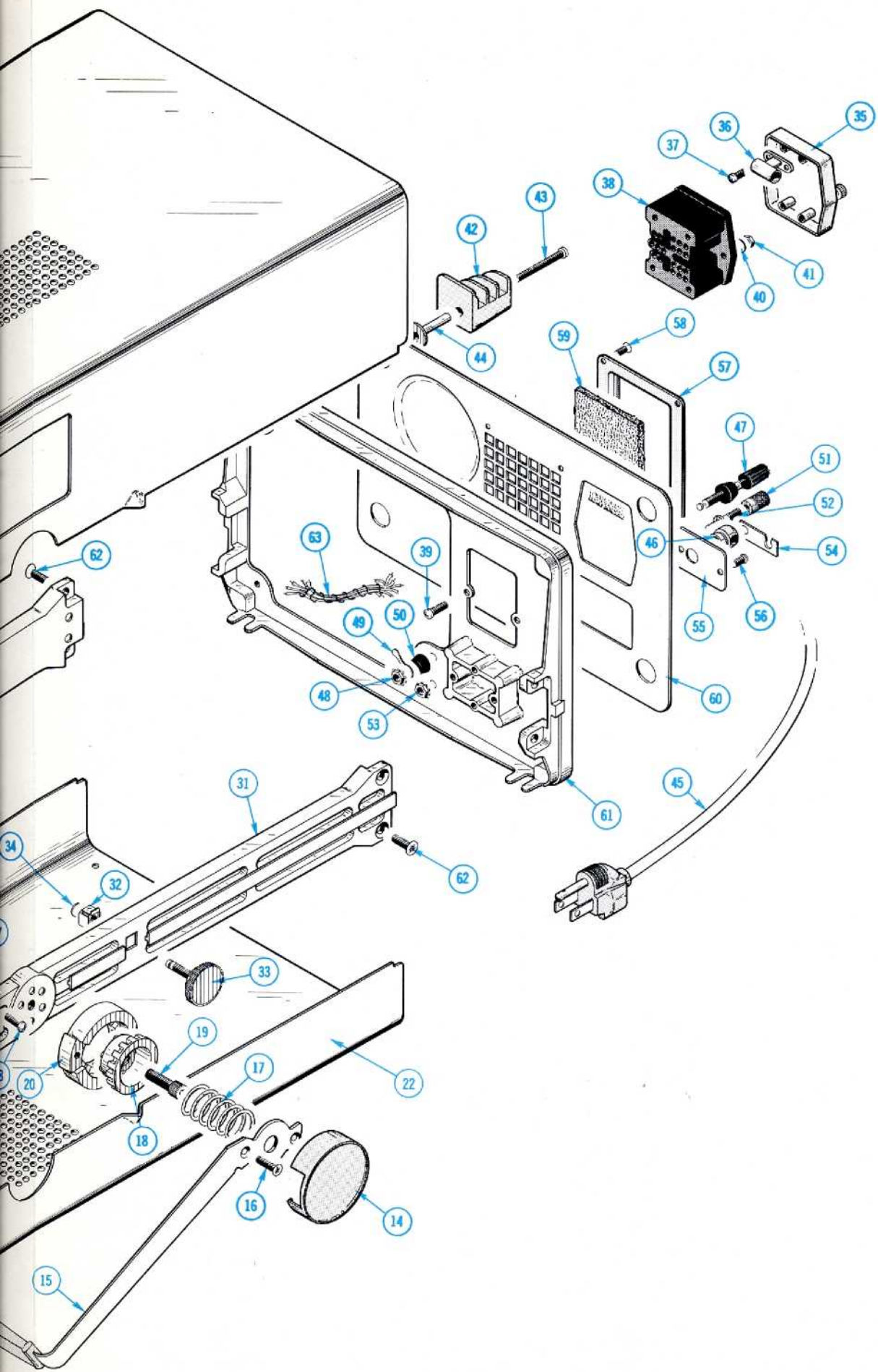


FIGURE 4 453A FRAME & CABINET

Fig. & Index No.	Tektronix Part No.	Serial/Model No. Eff	No. Disc	Q					Description	
				t	Y	1	2	3		4
4-1	200-0633-02			1						COVER ASSEMBLY, front
-2	214-0531-01			-						cover assembly includes:
				2						LATCH ASSEMBLY
-3	210-0666-00			-						mounting hardware for each: <i>(not included w/latch assembly)</i>
				2						RIVET
-4	348-0013-00			4						FOOT, rubber
-5	214-0755-00			2						PIN, hinge, plastic
-6	252-0571-00			ft						EXTENSION, plastic, 3 feet long
-7	348-0091-00			1						CUSHION, cover, bottom
-8	200-0710-00			1						DOOR, accessory storage
				-						door includes:
-9	352-0093-00			1						HOLDER, fuse, storage
				-						mounting hardware: <i>(not included w/holder)</i>
-10	210-0696-00			2						EYELET
-11	204-0282-00			1						BODY, latch
-12	214-0787-00			1						STEM, latch
-13	348-0118-00			1						PAD, cushion, door
-14	200-0602-00			2						COVER, handle latch
-15	367-0058-02			1						HANDLE, carrying
				-						mounting hardware: <i>(not included w/handle)</i>
-16	211-0512-00			4						SCREW, 6-32 x 0.50 inch, 100° csk, FHS
-17	214-0516-00			2						SPRING, handle index
-18	214-0578-00			2						HUB, handle index
				-						mounting hardware for each: <i>(not included w/hub)</i>
-19	213-0129-00			1						SCREW, hex., 0.25-20 x 0.75 inch, SHS
-20	214-0513-00			2						INDEX, handle ring
-21	334-1418-00			1						PLATE, identification
-22	386-1177-00			1						PLATE, cabinet bottom
-23	348-0080-01			4						FOOT, cabinet
				-						mounting hardware for each: <i>(not included w/foot)</i>
-24	211-0504-00			1						SCREW, 6-32 x 0.25 inch PHS
-25	210-0005-00			1						WASHER, lock, internal, 0.146 ID x 0.283 inch OD
-26	386-1178-00			1						PLATE, cabinet, top
-27	343-0004-00			1						CLAMP, cable, plastic, 0.312 inch diameter
				-						mounting hardware: <i>(not included w/clamp)</i>
-28	211-0511-00			1						SCREW, 6-32 x 0.375 inch, PHS
-29	210-0863-00			1						WASHER, "D" shape, 0.191 ID x 0.515 inch
-30	210-0457-00			1						NUT, keps, 6-32 x 0.312 inch

FIGURE 4 453A FRAME & CABINET (cont)

Fig. & Index No.	Tektronix Part No.	Serial/Model No.		Q † Y	Description
		Eff	Disc		
4-31	426-0260-00			2	FRAME, rail
	- - - - -			-	each frame includes:
-32	220-0439-00			1	NUT, speed grip retainer, 0.25-20 inch
-33	214-0910-01			2	SCREW, cabinet latch
	- - - - -			-	mounting hardware for each: <i>(not included w/screw)</i>
-34	354-0175-00			1	RING, retaining
-35	200-0704-00			1	COVER, line voltage selector
	- - - - -			-	cover includes:
-36	352-0102-00			2	HOLDER, fuse, plastic
	- - - - -			-	mounting hardware for each: <i>(not included w/holder)</i>
-37	213-0035-00			2	SCREW, thread cutting, 4-40 x 0.25 inch, PHS
-38	204-0279-00			1	BODY, line voltage selector
-39	211-0513-00			-	mounting hardware: <i>(not included w/body)</i>
	- - - - -			2	SCREW, 6-32 x 0.625 inch, PHS
-40	210-0006-00			2	WASHER, lock, internal, 0.146 ID x 0.283 inch OD
-41	210-0407-00			2	NUT, hex., 6-32 x 0.25 inch
-42	348-0258-00			4	FOOT, cabinet, w/cord wrap
	- - - - -			-	mounting hardware for each: <i>(not included w/foot)</i>
-43	212-0082-00			1	SCREW, 8-32 x 1.25 inch, PHS
-44	129-0294-00			1	POST, 0.188 ID x 0.26 OD x 1.03 inch long
-45	161-0033-07			1	CORD, power, 3 conductor
-46	358-0323-00			1	BUSHING, strain relief
-47	129-0064-00			1	POST, binding
	- - - - -			-	mounting hardware: <i>(not included w/post)</i>
-48	210-0457-00			1	NUT, keps, 6-32 x 0.312 inch
-49	210-0203-00			1	LUG, solder, SE #6, long
-50	358-0181-00			1	BUSHING, plastic
	129-0020-00			1	BINDING POST ASSEMBLY
	- - - - -			-	binding post assembly includes:
-51	200-0072-00			1	CAP, binding post
-52	355-0503-00			1	STEM, adapter
	- - - - -			-	mounting hardware: <i>(not included w/binding post assembly)</i>
-53	220-0410-00			1	NUT, keps, 10-32 x 0.375 inch
-54	346-0043-00			1	STRAP, gound
-55	386-1122-00			1	PLATE, power cord
	- - - - -			-	mounting hardware: <i>(not included w/plate)</i>
-56	211-0504-00			2	SCREW, 6-32 x 0.25 inch, PHS

FIGURE 4 453A FRAME & CABINET (cont)

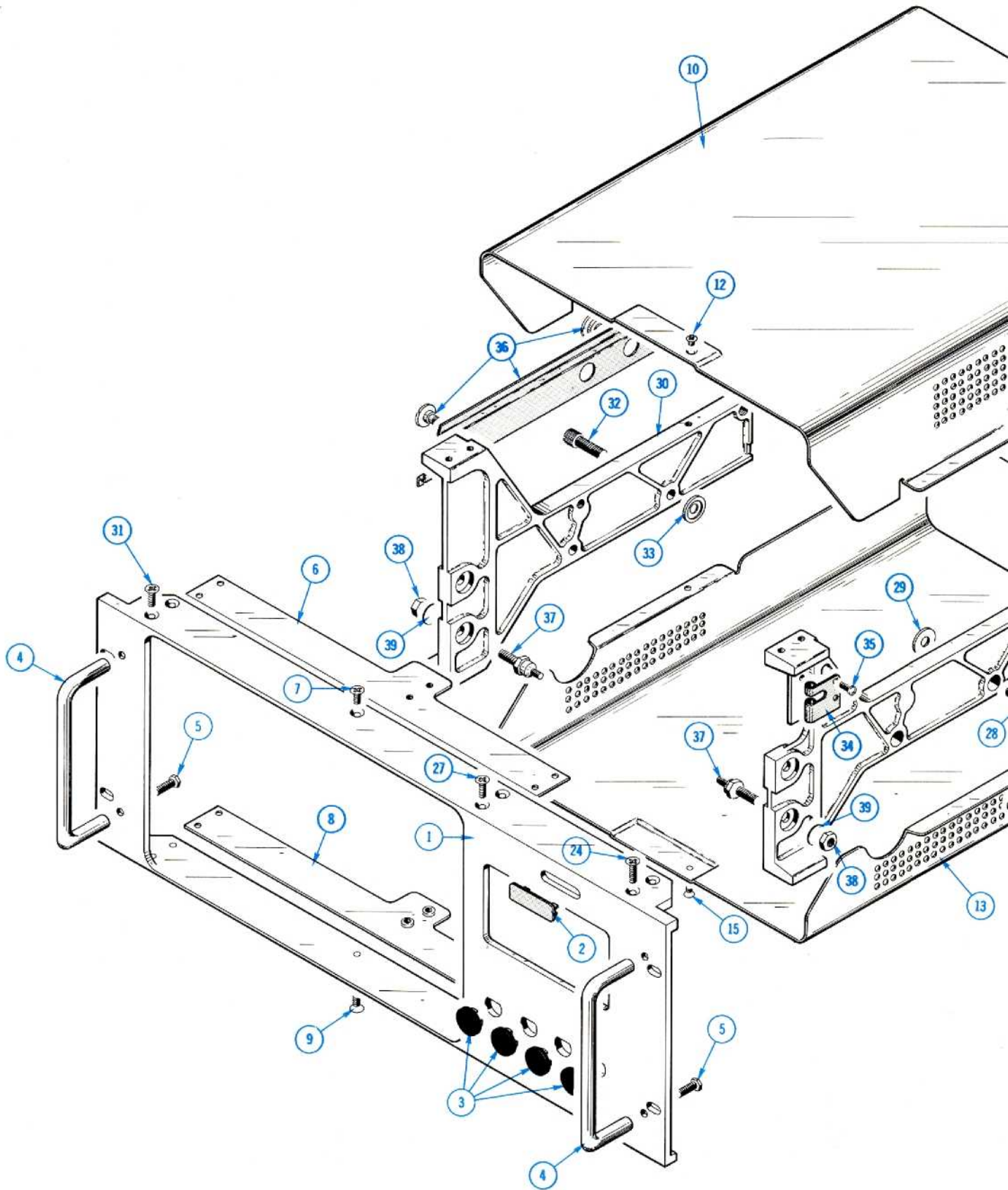
Fig. & Index No.	Tektronix Part No.	Serial/Model No. Eff	No. Disc	Q					Description	
				t	y	1	2	3		4
4-57	380-0082-00			1						HOUSING, fan filter
	- - - - -			-						mounting hardware: <i>(not included w/housing)</i>
-58	213-0107-00			4						SCREW, thread forming, 4-40 x 0.25 inch, 100° csk, FHS
-59	378-0036-01			1						FILTER, air
-60	386-1187-00			1						PANEL, rear
-61	426-0317-01			1						SUBPANEL, rear
	- - - - -			-						mounting hardware: <i>(not included w/subpanel)</i>
-62	212-0506-00			4						SCREW, 10-32 x 0.375 inch, 100° csk, FHS
-63	179-1140-00			1						WIRING HARNESS, w/connectors, line voltage

FIGURE 5 R453A CABINET

Fig. & Index No.	Tektronix Part No.	Serial/Model Eff	No. Disc	Q						Description
				y	1	2	3	4	5	
5-1	426-0378-01			1						FRAME, front
-2	334-1120-02			1						PLATE, identification
-3	134-0067-00			4						PLUG, gray plastic
-4	367-0022-00			2						HANDLE
-5	213-0090-00			-						mounting hardware for each: <i>(not included w/handle)</i>
				2						SCREW, 10-32 x 0.50 inch, HHS
-6	386-1063-00			1						PLATE, front frame backing, top
				-						mounting hardware: <i>(not included w/frame)</i>
-7	212-0002-00			1						SCREW, 8-32 x 0.25 inch, 100° csk, FHS
-8	386-1062-00			1						PLATE, front frame backing, top
				-						mounting hardware: <i>(not included w/plate)</i>
-9	212-0002-00			1						SCREW, 8-32 x 0.25 inch, 100° csk, FHS
-10	390-0012-00			1						CABINET TOP
				-						mounting hardware: <i>(not included w/cabinet top)</i>
-11	212-0001-00			2						SCREW, 8-32 x 0.25 inch, PHS
-12	211-0502-00			1						SCREW, 6-32 x 0.188 inch, 100° csk, FHS
-13	390-0013-00			1						CABINET BOTTOM
				-						mounting hardware: <i>(not included w/bottom)</i>
-14	212-0001-00			2						SCREW, 8-32 x 0.25 inch, PHS
-15	211-0502-00			1						SCREW, 6-32 x 0.188 inch, 100° csk, FHS
-16	386-1261-00			1						PLATE, rear
				-						mounting hardware: <i>(not included w/plate)</i>
-17	212-0010-00			4						SCREW, 8-32 x 0.625 inch, PHS
-18	210-0808-00			1						WASHER, centering
				-						mounting hardware: <i>(not included w/washer)</i>
-19	211-0507-00			1						SCREW, 6-32 x 0.312 inch, PHS
-20	210-0457-00			1						NUT, keps, 6-32 x 0.312 inch
-21	386-1064-00			1						PLATE, side
				-						mounting hardware: <i>(not included w/plate)</i>
-22	212-0023-00			1						SCREW, 8-32 x 0.375 inch, PHS
-23	212-0040-00			1						SCREW, 8-32 x 0.375 inch, 100° csk, FHS
-24	212-0043-00			4						SCREW, 8-32 x 0.50 inch, 100° csk, FHS
-25	210-0458-00			6						NUT, keps, 8-32 x 0.344 inch
-26	426-0358-01			1						FRAME, support right
				-						mounting hardware: <i>(not included w/frame)</i>
-27	212-0040-00			4						SCREW, 8-32 x 0.375 inch, 100° csk, FHS
-28	213-0129-00			2						SCREW, 0.25-20 x 0.75 inch, HSS
-29	361-0120-00			1						SPACER, stepped

FIGURE 5 R453A CABINET (cont)

Fig. & Index No.	Tektronix Part No.	Serial/Model No. Eff Disc	Q					Description	
			t	Y	1	2	3		4
5-30	426-0363-01		1						FRAME, support, left - mounting hardware: <i>(not included w/frame)</i>
-31	212-0040-00		4						SCREW, 8-32 x 0.375 inch, 100° csk, FHS
-32	213-0129-00		2						SCREW, 0.25-20 x 0.75 inch, HSS
-33	361-0120-00		1						SPACER, stepped
-34	214-0881-00		1						HINGE - mounting hardware: <i>(not included w/hinge)</i>
-35	211-0503-00		2						SCREW, 6-32 x 0.188 inch, PHS
-36	351-0104-00		1						GUIDE <i>(pair)</i> , w/hardware
-37	355-0114-00		4						STUD - mounting hardware for each: <i>(not included w/stud)</i>
-38	210-0411-00		1						NUT, hex., 0.25-20 x 0.438 inch
-39	210-0011-00		1						WASHER, lock, internal, 0.25 ID x 0.469 inch OD



+

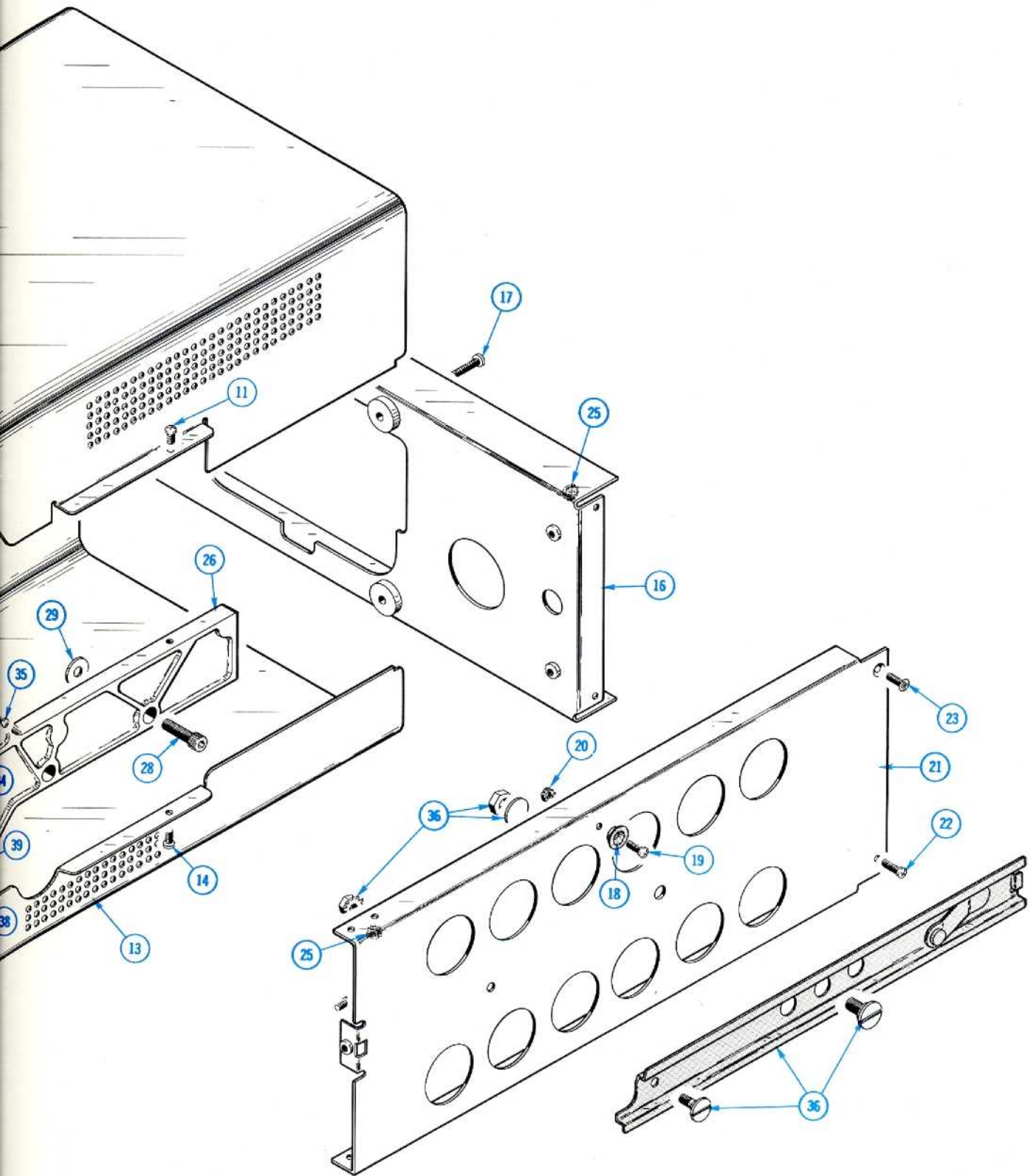


FIG. 5 R453A CABINET

+



Fig. & Index No.	Tektronix Part No.	Serial/Model No.		Q t y	1	2	3	4	
		Eff	Disc						
6-1	010-6061-01			2				PROBE	
-2	012-0076-00			1				CABLE,	
-3	012-0092-00			1				JACK, B	
-4	159-0021-00			2				FUSE, fa	
	159-0022-00			1				FUSE, fa	
	159-0025-00			1				FUSE, fa	
	159-0028-00			1				FUSE, fa	
	070-1105-00			1				MANUAL	
	070-1089-00			1				MANUAL	
OTHER PARTS FURNISHED WITH									
	016-0096-00			1				KIT, rug	
	016-0099-00			1				KIT, rack	
	351-0101-00			1				TRACK,	



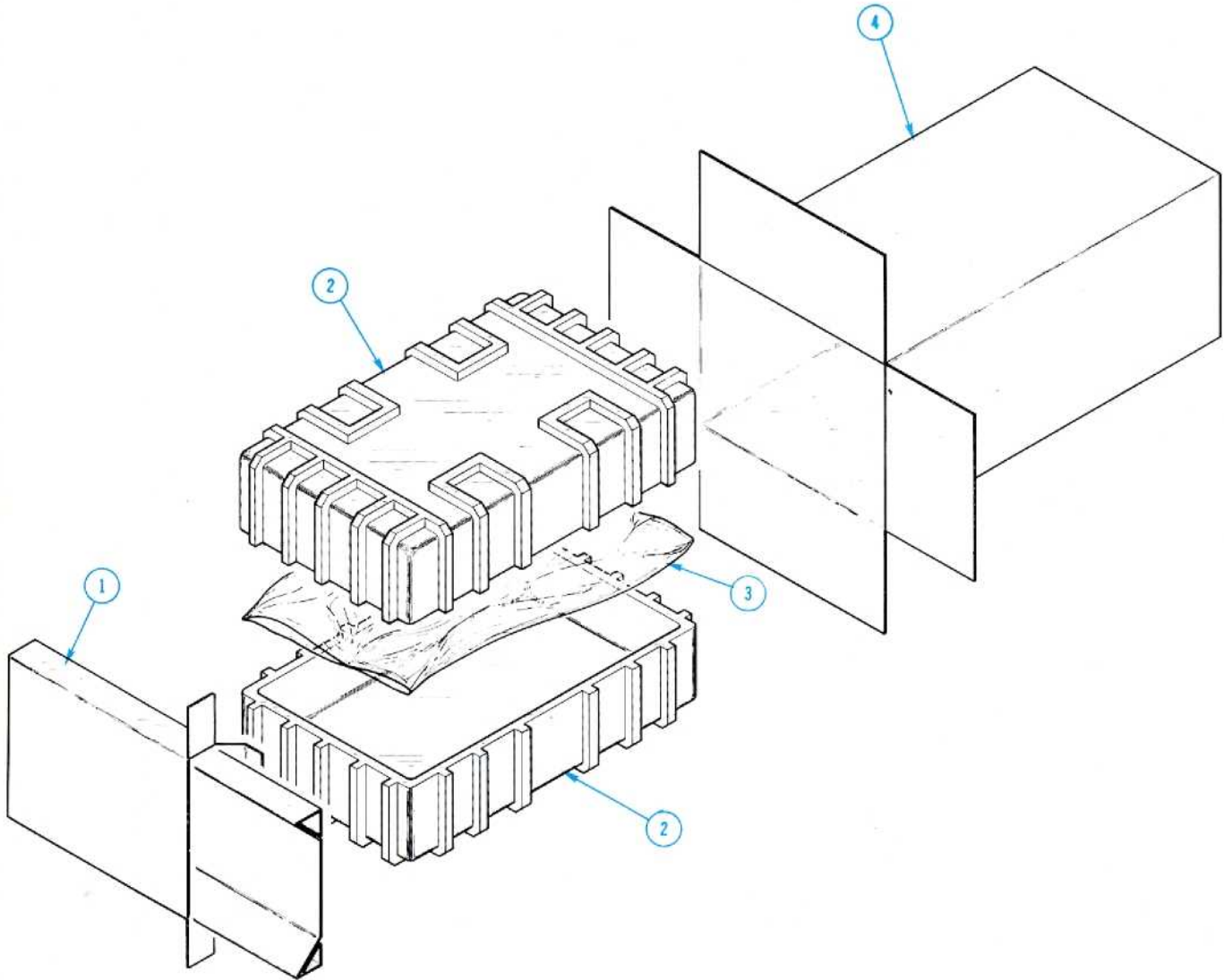
Serial/Model No.	Q						Description
Disc	t	1	2	3	4	5	
	y	2					PROBE PACKAGE, P6061
		1					CABLE, BNC to BNC, 18 inches long
		1					JACK, BNC-post
		2					FUSE, fast blo, 2 amp, 3AG
		1					FUSE, fast blo, 1 amp, 3AG
		1					FUSE, fast blo, 0.50 amp, 3AG
		1					FUSE, fast blo, 0.25 amp, 3AG
		1					MANUAL, operators (not shown)
		1					MANUAL, instruction (not shown)

OTHER PARTS FURNISHED WITH R453A ONLY

- 1 KIT, ruggedizing hardware (not shown)
- 1 KIT, rackmounting hardware (not shown)
- 1 TRACK, slide, stationary & intersection (not shown)

CARTON ASSEMBLY
(Part No. 065-0076-00)

+



Ⓐ

Fig. & Index No.	Tektronix Part No.	Serial/Model No. Eff	No. Disc	Q					Description	
				†	1	2	3	4		5
7-	065-0076-00			1						CARTON ASSEMBLY
-1	004-0685-00			-						carton assembly includes:
-2	004-0222-00			1						CARTON, accessory, w/pad
-3	006-0342-00			2						CASE HALF
-4	004-0679-00			1						BAG, plastic
				1						CARTON

453A/R453A OSCILLOSCOPE

Ⓐ
+

+

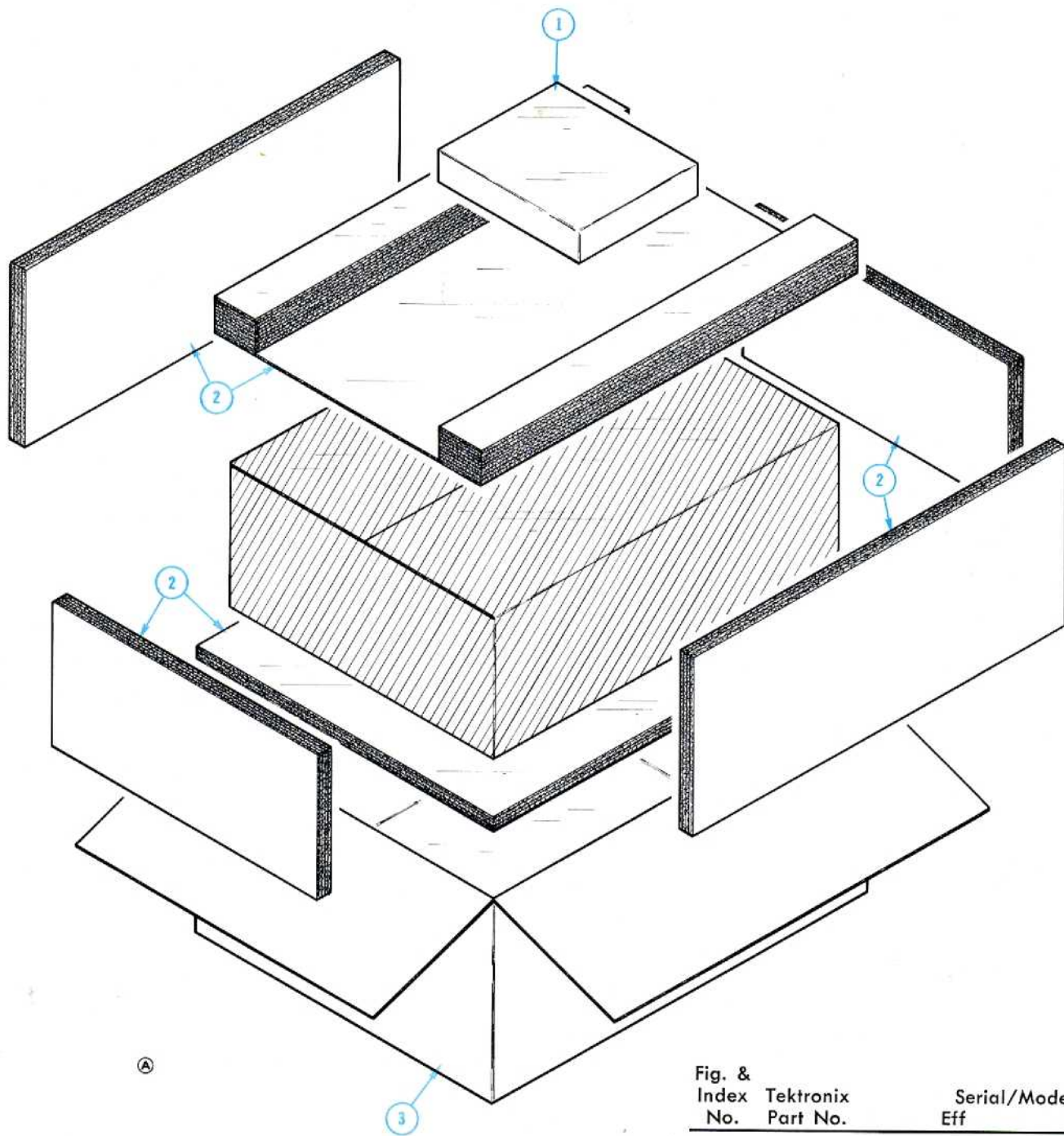
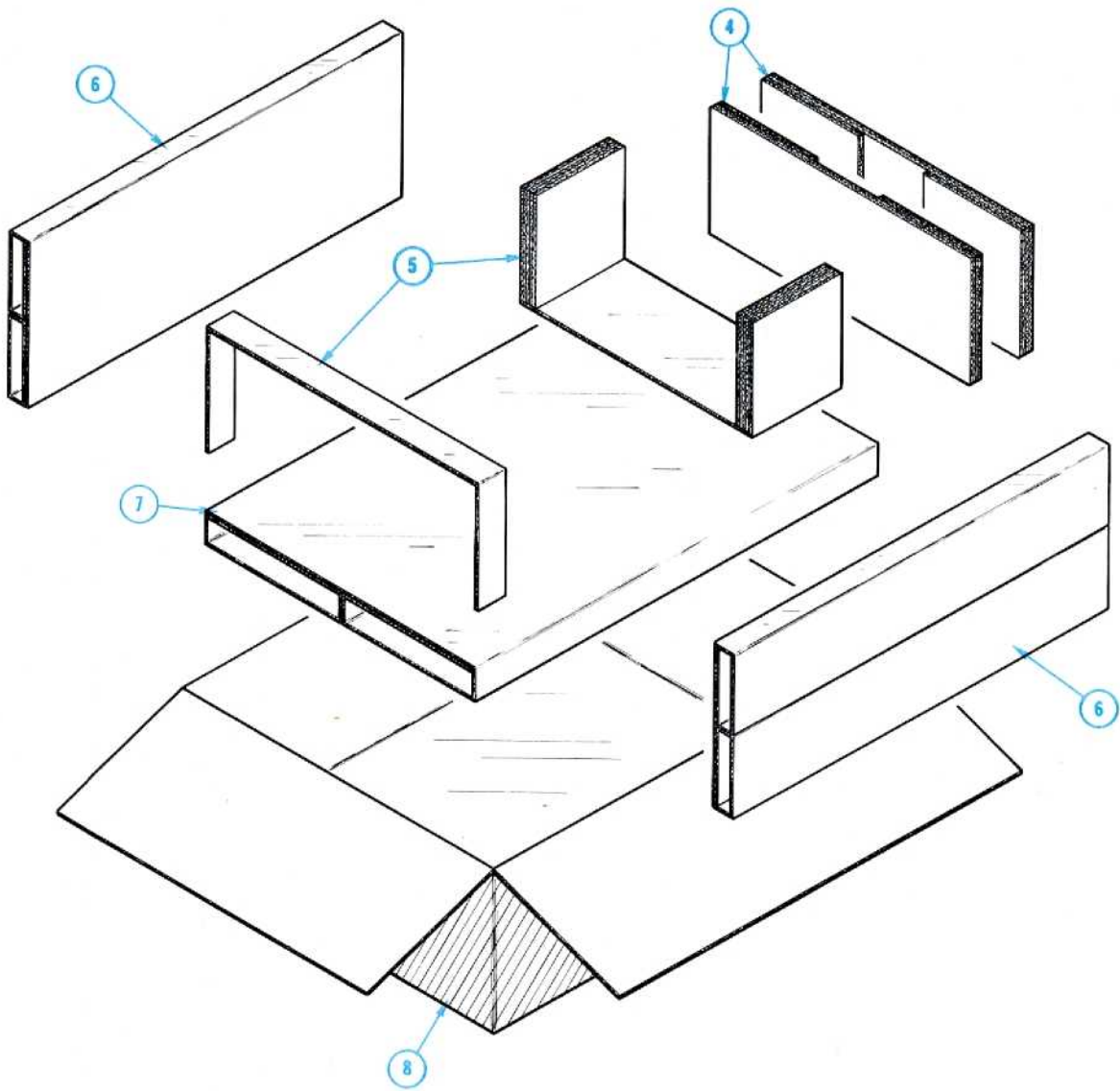


Fig. & Index No.	Tektronix Part No.	Serial/Model No. Eff	No. Disc	Qty
8-	065-0101-00			1
-1	004-0704-00			1
-2	004-0361-00			1
-3	004-0461-00			1
-4	004-0566-00			2
-5	004-0359-00			1
-6	004-0360-00			1
-7	004-0357-00			1
-8	004-0460-00			1



No. Disc	Qty	Description
----------	-----	-------------

- 1 CARTON ASSEMBLY
- carton assembly includes:
- 1 CARTON, accessory
- 1 PAD SET, 6 piece
- 1 CARTON, outer
- 2 PAD
- 1 PAD SET, 2 piece
- 1 PAD SET, side, 2 piece
- 1 PAD, bottom
- 1 CARTON, inner

Ⓐ

+

MANUAL CHANGE INFORMATION

At Tektronix, we continually strive to keep up with latest electronic developments by adding circuit and component improvements to our instruments as soon as they are developed and tested.

Sometimes, due to printing and shipping requirements, we can't get these changes immediately into printed manuals. Hence, your manual may contain new change information on following pages.

A single change may affect several sections. Sections of the manual are often printed at different times, so some of the information on the change pages may already be in your manual. Since the change information sheets are carried in the manual until ALL changes are permanently entered, some duplication may occur. If no such change pages appear in this section, your manual is correct as printed.

453A EFF. SN B0140000-up
453A-1/2/3 EFF SN B070000-up
453A-4 EFF SN B070000-up

Page 1

ELECTRICAL PARTS LIST CORRECTIONS

A6 LOW VOLTAGE REGULATOR Circuit Board Assembly

CHANGE TO:

(453A)	670-0415-03	Complete Board
(453A-1/2/3)	670-0415-04	Complete Board
(453A-4)	670-0415-04	Complete Board

CHANGE TO:

R1122	311-1223-00	250 Ω Var.
R1152	311-1222-00	100 Ω Var.
R1182	311-1223-00	250 Ω Var.

MECHANICAL PARTS LIST CORRECTIONS

CHANGE TO:

453A Page 9-18 Fig. 3-110	670-0415-03	1	CIRCUIT BOARD ASSEMBLY-LOW VOLTAGE REG. A6
453A-1/2/3 Page 8-14 Fig. 2-110	670-0415-04	1	CIRCUIT BOARD ASSEMBLY-LOW VOLTAGE REG. A6
453A-4 Page 8-13 Fig. 2-98	670-0415-04	1	CIRCUIT BOARD ASSEMBLY-LOW VOLTAGE REG. A6

M17673/673