



# PICOTEST

## Signal Injectors

---



## Documentation

Version 1.2, January, 2016

Copyright © 2011-2016 Picotest

All Rights Reserved

## **Trademarks**

The Picotest logo and “Picotest Injectors” are trademarks of Picotest Corp.

All other brand and product names mentioned herein are used for identification purposes only and are registered trademarks, trademarks, or service marks of their respective holders.

## **Copyright notice**

Except as permitted under the United States Copyright Act of 1976, no part of this publication may be reproduced or distributed in any form or by any means, or stored in a data base or retrieval system, without the prior written permission of Picotest Corp.

## **Contact information**

Corporate offices      1-877 914-PICO

Technical support e-mail      [info@picotest.com](mailto:info@picotest.com)

World Wide Web      <https://www.picotest.com>

# Table of Contents

<b>Chapter 1 - Overview</b> .....	<b>5</b>
Welcome .....	5
What's Included .....	6
Documentation and Support .....	6
Warranty.....	7
Calibration.....	7
Safety Information.....	7
<b>Chapter 2 – Introduction to Signal Injectors</b> .....	<b>8</b>
Introduction.....	8
Injection Transformers – J2100A & J21101A.....	9
Solid State Voltage Injector – J2110A .....	10
Solid State Current Injectors – J2111A & J2112A.....	12
Line Injector – J2120A .....	13
Bias Injector – J2130A, P2130A.....	14
Attenuators – J2140A.....	14
USB Harmonic Comb Injector – J2150A .....	14
Preamplifier – J2180A.....	15
Active Filter – J2190A.....	15
Common Mode Transformer – J2102A.....	15
<b>Chapter 3 - Signal Injectors: Measurements and Specifications</b> .....	<b>16</b>
J1200A/J2101A Injection Transformers.....	16
Main Features .....	16
Description.....	17
Connecting the Injection Transformer: Stability .....	18
Technical Specifications: J2100A.....	19
Technical Specifications: J2101A.....	20
J2110A Solid State Voltage Injector.....	22
Main Features .....	22
Description.....	22
Connecting the Solid State Injector: : Stability .....	22
Technical Specifications .....	23
J2120A Line Injector.....	24
Main Features .....	24
Description.....	24
Connecting the Line Injector: PSRR.....	24
Measuring Input Impedance.....	25
Connecting the Line Injector: Input Impedance.....	25
Technical Specifications and Block Diagram.....	26
P2130A - J2130A DC Blocker/DC Bias Injector.....	28
J2130A Main Features .....	28

Description.....	28
Connecting the DC Bias Injector: Component Bias.....	29
Technical Specifications .....	29
P2130A Main Features .....	30
J2111A/J2112A Solid State Current Injector.....	32
Main Features .....	32
Description.....	32
J2111A vs. the J2112A.....	33
J2111A – J2112A Injector Similarities .....	34
J2111A – J2112A Injector Differences .....	34
Basic Operation of the Current Injector and Other FAQs .....	34
Connecting the Current Injector Example: Output Impedance VNA measurement ....	35
Technical Specifications .....	37
J2170A High PSRR Power Supply Adapter .....	39
Main Features .....	39
Description.....	39
J2140A Attenuators.....	40
Main Features .....	40
Description.....	40
Technical Specifications .....	40
J2180A 0.1Hz to 100MHz Ultra Low Noise Preamp .....	42
Main Features .....	42
Description.....	42
Connecting the Preamp: EMI and Noise Measurements .....	43
Technical Specifications .....	44
J2190A 0.1Hz to 10Hz Active Filter.....	45
Main Features .....	45
Description.....	45
J2102A Common Mode Transformer .....	47
Main Features .....	47
Description.....	47
Technical Specifications .....	51
Injector Input/Output Impedances.....	52

## Chapter 1 - Overview

### Welcome

Thank you for purchasing one or more of Picotest's Signal Injectors.

Regulator and SMPS applications today are much more demanding than ever. Today's designs require increases in switching frequency and bandwidth, higher efficiency and lower standby current. A high resolution, high fidelity test setup is more critical than ever to getting the accurate measurements you need.

Picotest Signal Injectors are designed to greatly improve the accuracy of your test results.

#### **Summary of Benefits:**

- More accurate voltage regulator and power supply measurements
- Ability to your test systems' stability and step load non-invasively
- Ability to your test systems' stability in the production circuit configuration
- Ability to make high fidelity PSRR measurements
- Ability to test output impedance
- Ability to bias components under test
- Greatly reduce distortion in Bode and impedance measurements
- Improve RSA, SA and MDO measurements related to noise and EMI

## What's Included

Your Picotest Signal Injector set includes one or more of the following:

- **J2100A** Injection Transformer (1Hz-5MHz) – Stability, Gain/Phase
- **J2101A** Injection Transformer (10Hz-45MHz) – Stability, Gain/Phase
- **J2110A** Solid State “Bode Box” voltage injector \* – Stability, Gain/Phase
- **J2111A** Solid State current injector \* – Non-invasive stability, impedance, and step load
- **J2112A** Solid State high current injector \* – Non-invasive stability, impedance, and step load measurements
- **J2120A** Line Injector - PSRR, Ripple Rejection and Conducted Susceptibility
- **P2130A/J2130A** DC Blocking, DC Bias Injector – Impedance, Component biasing
- **J2140A** Attenuators – Stability, noise
- **J2150A** USB Harmonic Comb Injector – EMI/EMC, Cables, See the J2150A manual for more information on this injector
- **J2170A** High PSRR adapter (used to power the J2110A, J2111A, J2112A, J2180A, & J2190A)
- **J2180A** 0.1Hz – 100MHz Ultra Low Noise Preamp \* - Noise, EMI
- **J2190A** 0.1Hz – 10Hz Active Filter \* - Noise, EMI
- **J2102A** Common Mode Transformer - Impedance

\* Note: the J2170A low noise, high PSRR power adapter, is used to power the J2110A, J2180A, J2190A, J2111A or the J2112A. The J2170A is included if you purchase any one of the aforementioned injectors. No other power adapter should be used with these injectors. The other adapters not listed do not require external power. One J2170A is included with each Signal Injector Bundle (set of Signal Injectors). One J2170A will be included with each injector requiring external power if the injector is purchased individually.

## Documentation and Support

This documentation details the use of various Signal Injectors. Specifications for the individual injectors are also included.

The support section of Picotest’s web site, <https://www.picotest.com/support.html>, contains additional documentation and various publications on testing power supplies, regulators, and other equipment using the Picotest Signal Injectors.

## Warranty

Every Picotest product you buy from Picotest.com is backed by a 3 year manufacturer's warranty.

For warranty service or repair this product must be returned to a service facility designated by PICOTEST. Please contact your local service representative for further assistance.

## Calibration

The Signal Injectors do not require calibration.

## Safety Information



Caution: To avoid equipment damage and/or severe injuries or death ensure that the absolute maximum ratings defined in this manual are observed at all times.

Please note that the absolute maximum voltages ratings are below 50VAC and 75VDC for the following Signal Injectors: J2110A, J2111A, J2180A, J2102A, J2120A, J2112A, J2130A, J2140A, J2150A, P2130A

## Chapter 2 – Introduction to Signal Injectors

### Introduction

Signal Injectors, also known as test adapters or interface adapters, are used to inject or transmit signals into and from various circuits so that the circuit's characteristics can be tested. Tests include Bode plot control loop analysis, circuit and component impedance measurements and conducted susceptibility measurements, to name just a few.

The network analyzer, sometimes referred to as a Frequency Response Analyzer (“FRA”) or Vector Network Analyzer (“VNA”), is a common piece of equipment in most electronics labs. Analyzers are used for a variety of tasks including stability analysis, component characterization and of course frequency response measurements. They can vary in features, but regardless of the analyzer being used, the analyzer oscillator signal must be injected into the circuit being tested in order for a measurement to be made.

The quality of the test signal injector, or test adapter, and the injection method can have a direct impact on the test results. For example, it is often the case that we see hobby store transformers used to inject signals into the loops of power supplies. In this case, the results are likely to be distorted due to the poor frequency response and impedance matching of the transformer.

It is critical that you understand the bandwidth limitations and the impedance of the test interface adapter, as well as, the impact of the injection signal magnitude on the measurement if you want to get accurate and repeatable test results.



Different injectors are used for different tests. In some cases, more than one injector will support various aspects of the test. The details can be found in the following sections.

The Picotest Injectors may be used with any network analyzer including those from OMICRON Lab, Agilent, Venable, Ridley and others. Please refer to the connection diagrams, shown with each injector, to see how each is interconnected with your test equipment.

## Injection Transformers – J2100A & J21101A

The injection transformer is by far the prevalent method for connecting the network analyzer to a circuit being tested for loop stability (Figure 1). The goal of the transformer is to inject a signal into the control loop being measured, without impacting the performance of the loop. In order to accomplish this to a reasonable degree, it is important to pick an injection point that is unaffected by the terminating impedance of the transformer, which is often in the range of 5 to 50 Ohms.

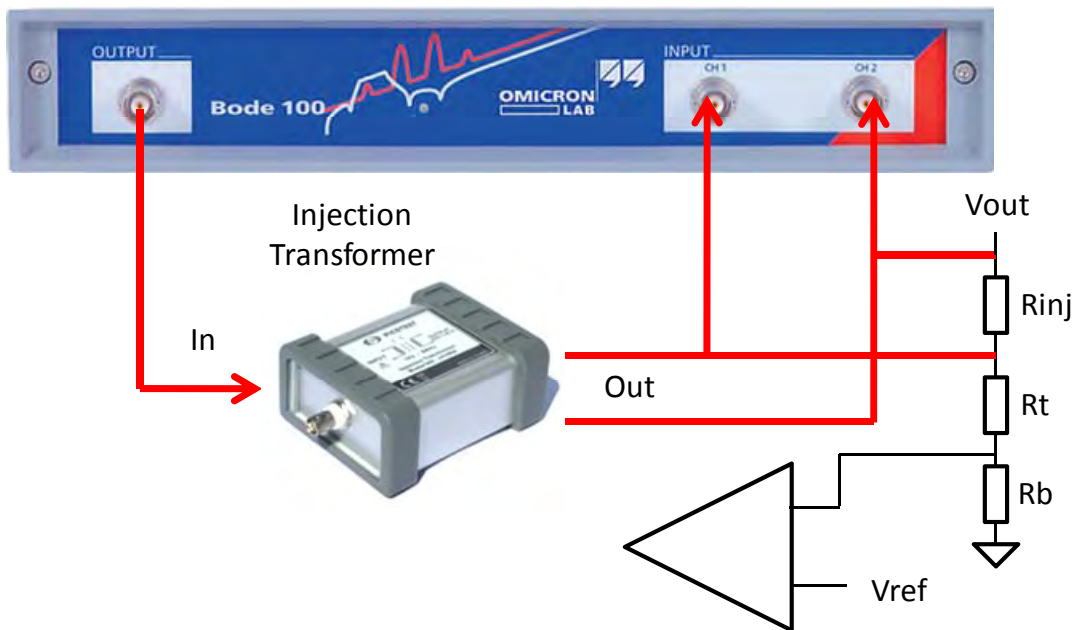

Figure 1: Sample setup for the injection transformer (J2100A or J2101A) used to perform stability measurements.

The transformer itself is outside of the measurement, leading many to incorrectly believe that the transformer is a non-critical element. The frequency range of the injection signal is dependent on the circuit being measured. The measurement of a typical Power Factor Corrector (PFC) control loop generally requires a measurement frequency of 1Hz or lower, as it is common for a PFC to have a control loop bandwidth of less than several Hz. The bandwidth of a high performance linear regulator can be as high as several MHz. While several different transformers can be used to address this range, it is beneficial to use a single transformer or two transformers covering different frequency bands at most, due to the high cost of the transformers.

The design of a transformer that has significant permeability at 1Hz and minimal attenuation at 10MHz or more is difficult to achieve. The core materials are quite expensive and the transformers generally must be hand wound. These issues, combined with the relatively small market volume size dictate the cost. Engineers often use audio transformers or hum eliminators as signal injection transformers. The result is that the incorrect results are invariably produced from the use of these poor injection transformers.

## Solid State Voltage Injector – J2110A

While it is possible to obtain high quality injection transformers with bandwidths as wide as 1Hz to 5MHz or more, in some cases this is still insufficient for the testing of some circuits. For example, a typical heater control loop might have a bandwidth of less than 1Hz while some linear regulators and opamp circuits can have bandwidths of up to 100MHz or greater. For these applications, a solid state injector can provide the necessary bandwidth. The solid-state injector is often called a “Bode Box.” A solid state injector can perform at DC, while the upper frequency limit is dictated by the components selected and the printed circuit board material and layout. It is possible to obtain a solid state injector with a working range of DC – 200MHz, though above 50MHz the interconnection between the injector and the circuit being tested can become quite critical. It is essential that ripple from the injector’s power supply does not dramatically degrade the dynamic range or the signal to noise ratio of the measurement. Bode and other plots are often much cleaner when using a solid state injector than compared with those made with an injection transformer.

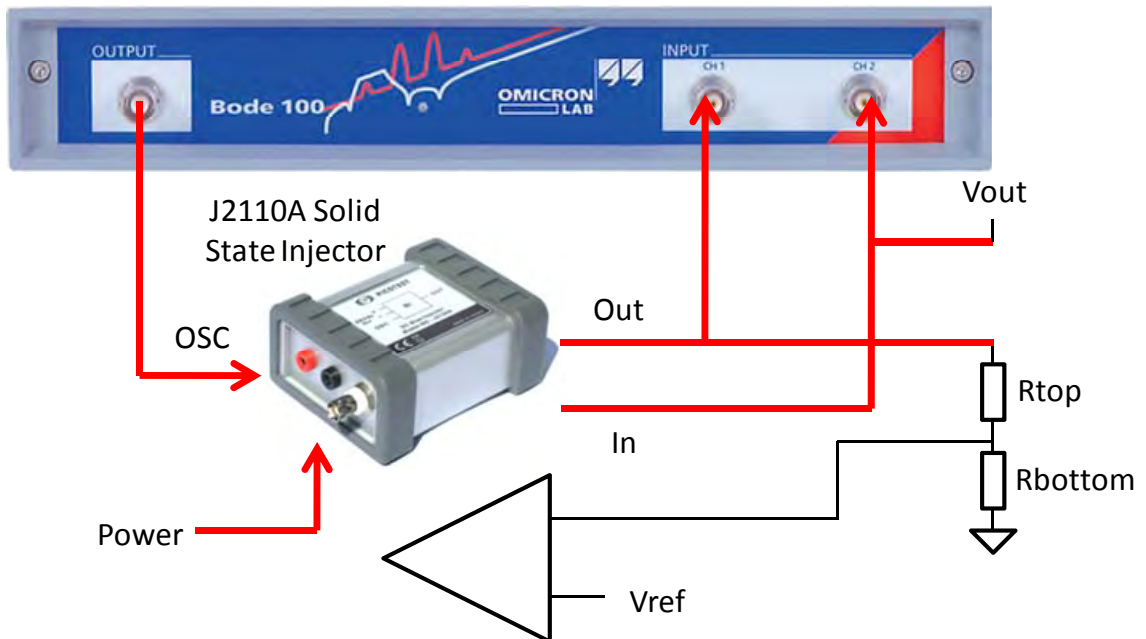

**Figure 2: Sample setup for the solid state injector “Bode Box” (J2110A) used to perform stability measurements.**

The selection of a valid injection point in the circuit is more critical when using a solid state injector than with the injection transformer. The solid state injector presents an infinite impedance between the points of injection. In order to provide correct results one side of the measurement must present a much higher impedance than the other side. In a typical power supply control loop, the voltage sense divider is generally a good injection point, since the output impedance of the power supply is very low compared with the impedance of the voltage sense divider.

The solid state injector is sometimes limited by its operating voltage, in this case  $\pm 12V$ . This is not the amplitude of the injection signal, but the DC operating voltage of the output that the injector is connected to. However, most applications requiring a solid state injector fall within these operational limits.

## Solid State Current Injectors – J2111A & J2112A

The current injector is possibly the most versatile of the Signal Injectors. While it is not designed to replace an electronic load, it is capable of performing a transient small-signal step loading at switching speeds and bandwidths that electronic loads cannot match. Also, the capacitance of an electronic load is generally too high and impacts the measurement where the J2111A and J2112A are minimally invasive. .

Incorporating a 40MHz current monitor, the current injector can also be used to measure output impedance, as well as, the stability of a filter, combined with the negative resistance of a switching converter or power supply. An added benefit is that using a current injector, these measurements can all be made using the full system loading since the injector is connected in parallel with the actual load.

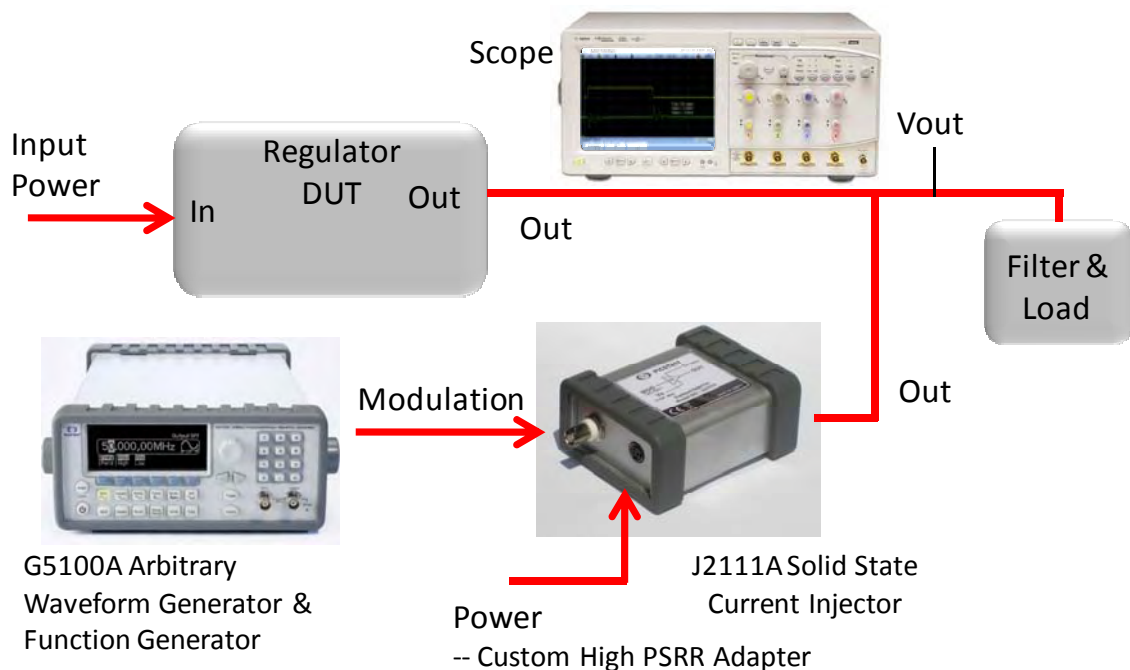

**Figure 3: Sample setup for the Solid State Current Injector (J2111A) used to perform a non-invasive load transient measurement.**

The J2111A current injector is a bilateral device, which works with positive or negative voltages and includes an internal bias for use with a network analyzer. The bias can be disconnected for use with an external waveform or arbitrary waveform generator such as the Picotest G5100A.

The current injector is basically a voltage to current converter with a gain of 10mA/V for the J2111A and 200mA/V for the J2112A. For example, with the J2111A, put in a 1V signal into the modulation port and you get 10mA out of the output port and 10mV out of the current monitor port. The current injector can be controlled by the output of the network analyzer (for frequency domain sweeps) or a function generator or arbitrary waveform generator (for time domain control and load profiling).

The J2111A current injector is capable of sinking 100mA while the J2112A can sink up to 1A. The J2112A is not bilateral and can only operate from positive voltages while the J2111A can sink current from either positive or negative voltages. There is no bias switch for the J2112A as the bias is always positive 24mA.

## Line Injector – J2120A

While the injection transformer is a very wideband adapter, it is not useful for measuring ripple rejection (PSRR) of a power supply or even an opamp. This is because the attributes that make the injection transformer perform so well also result in a transformer that is absolutely intolerant of DC current. Even very small DC currents (5mA or less) can greatly reduce the signal capacity or even totally saturate the transformer. For this reason, the line injector is another essential test adapter.

It allows a test signal to modulate the line or bus voltage. Like the current injector, the line injector can be controlled by a network analyzer's oscillator output or a time domain signal.

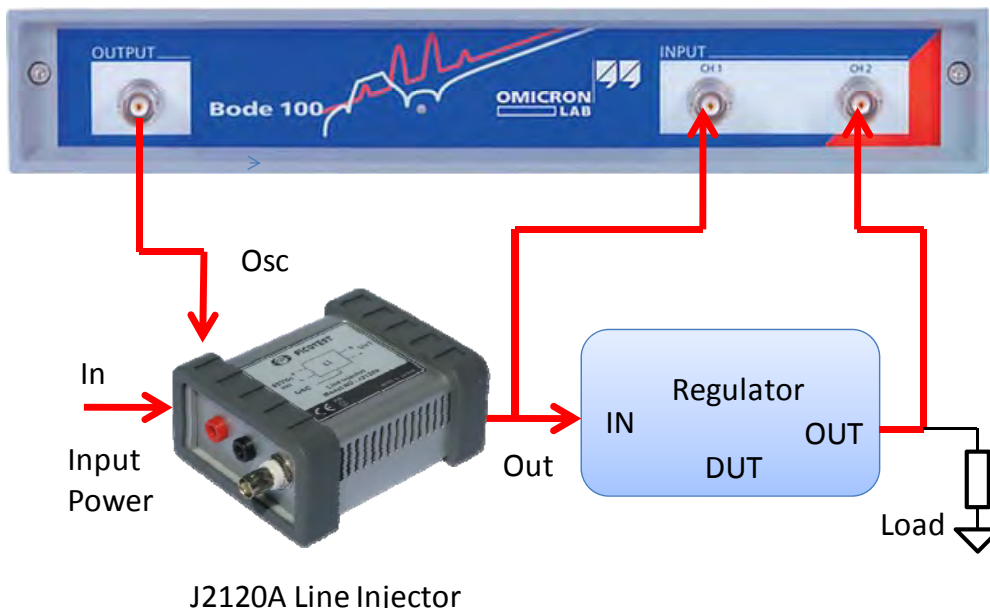

Figure 4: Sample setup for the Line Injector (J2120A) used to perform a PSRR measurement.

---

## Bias Injector – J2130A, P2130A

When using the network analyzer to measure impedance, such as the capacitance and ESR or a capacitor, or the DCR of an inductor, etc., it is often necessary to provide a voltage bias to the device being tested. This is true of semiconductor junction capacitances, varactors, and some ceramic capacitors (especially X5R). In these cases the impedance is a function of the DC bias on the device. The Picotest DC bias injector (J2130A) is used for this purpose during impedance measurements. The P2130A is a simple DC blocker that has a frequency response range of 500Hz - 6GHz while simultaneously providing low insertion loss and excellent VSWR. It is used when DC isolation is required to protect sensitive RF system components.

## Attenuators – J2140A

There are two common uses for attenuators when used in conjunction with the network analyzer. One is to attenuate the oscillator source signal. While this may seem odd, one of the most common errors in analyzer measurements is using a source signal that is too large. Even though the analyzer allows setting of the signal output amplitude, the lowest setting is often too high to allow an accurate small-signal measurement to be made. The correct amplitude is the smallest amplitude that exceeds the noise floor.

Attenuators are also useful for improving the dynamic range of the measurement. In some cases, as in measuring the open loop gain of an opamp as one example, the low frequency loop gain will be extremely large (100dB or more is not uncommon). Attenuating the output signal increases the effective range of the measurement.

## USB Harmonic Comb Injector – J2150A

The USB Harmonic Comb Injector is a fast, easy-to-use, ultra-portable signal generator for interrogating your PDN to identify noise sensitivities. It is used for cable testing, EMI/EMC chamber testing, and power integrity and clock jitter testing.

The injector supports 1kHz Impulse, 100kHz Impulse, 8MHz Impulse, and 10kHz Square wave outputs. Mode 1 repeatedly auto-cycles through the three impulse modes. Each impulse mode includes time and frequency jitter. The output is DC coupled so that the signal can also be used to modulate various Picotest voltage and current injectors. A separate P2130A DC blocker can be used to AC couple the output. The output voltage is 5V out into a high impedance termination, 2.5V into 50 ohms. Please see the Picotest web site for more information on the J2150A including a separate manual.

## Preamplifier – J2180A

The J2180A low noise preamplifier provides a fixed, AC coupled 20dB gain while converting a 1 MegOhm input impedance to a 50 Ohm output impedance. With a 3dB bandwidth of 0.1Hz to 100MHz, the preamplifier improves the sensitivity of oscilloscopes, network analyzers and spectrum analyzers while reducing the effective noise floor and spurious response. The preamplifier can also serve as a low frequency DC blocker for a spectrum analyzer or you can use it to connect a high input impedance oscilloscope probe to 50 Ohm equipment.

The J2180A preamplifier offers very low noise, fast 100V/uS slew rate for pulse applications and very low distortion for audio applications.

Note of Caution: the J2170A power supply is a switching supply and, therefore, radiates noise. The J2180A can pick-up this noise and amplify it and the result can be seen as spurs in the output spectrum of the J2180A, if it is close to the J2170A, or any other switching power supply for that matter. Please make sure to separate the J2170A power supply from the J2180A as far as the connecting cable with stretch in order to avoid this issue.

## Active Filter – J2190A

The J2190A active filter presents a high impedance (approximately 150kOhms) minimizing the loading of the circuit being tested. The output impedance is 50 Ohms allowing low noise coaxial connections to all typical test equipment. The 0.1Hz-10Hz noise band is common for opamp measurements, voltage regulators and voltage references.

The J2190A is a 4th order high pass and 4th order low pass filter with an optimally flat response and 0dB gain. Additional filters can be cascaded for even sharper cutoff.

The J2190A is not a programmable filter, though it is easily customizable to a particular noise bandwidth and/or circuit gain.

## Common Mode Transformer – J2102A

The J2102A is a common mode transformer used to attenuate the effects of low frequency ground loops for 2 port Shunt Thru impedance measurements. It is used for the Bode 100, Keysight E5061B (port 1-2 measurements) and most other VNAs.

## Chapter 3 - Signal Injectors: Measurements and Specifications

### J1200A/J2101A Injection Transformers

One of the most common tests performed by a network analyzer is the control loop stability measurement, or Bode plot. The injection transformer is the most prevalent method for connecting a network analyzer to the circuit in order to perform the stability measurements.

There are two different injection transformers, each with different overall bandwidths to support various types of applications.

#### Main Features

##### J2100A          1Hz-5MHz Transformer

- 1Hz supports PFC regulators
- 5MHz high enough for most power supplies and regulators
- 23 Octave range
- Low distortion for superior precision
- 5 Ohm termination for minimum impact to loop
- Includes attenuation to assure small signal measurement

##### J2101A          10Hz-45MHz Transformer

- 10Hz supports off-line power supplies
- 45MHz high enough for even state of the art regulators
- 23 Octave range
- Low distortion for superior precision
- 5 Ohm termination for minimum impact to loop
- Includes attenuation to assure small signal measurement



## Description

The goal of the transformer is to inject a signal into the control loop being measured, *without impacting the performance of the loop*. The test is performed by inserting an oscillator signal into the control loop, allowing an OPEN LOOP measurement in a CLOSED LOOP system. The analyzer sweeps the frequency while measuring the voltage at each side of the transformer. One side of the transformer is the input signal while the other side is the output signal. The division of the two results in the loop gain and loop phase, or bode response. The transformer is isolated and, therefore, capable of floating on a high voltage, such as in a Power Factor Corrector (PFC) circuit, which is often close to 400VDC.

The usable bandwidth of an injection transformer is generally significantly greater than its 3dB frequency limits. This is because the transformer itself is outside of the measurement, leading many to incorrectly believe that the transformer is a non-critical element.

The bandwidth of the transformer is strongly related to the terminating impedance (i.e. the impedance of the instrument). The source impedance of the oscillator in the Omicron Bode-100, and most other network analyzers, is 50 Ohms. Assuming this impedance, the recommended termination resistor is 5 Ohms. This significantly attenuates the injection signal, which is generally beneficial, as a common error in Bode measurements is using a signal which is too large, and therefore, resulting in a measurement that is not a “small signal” measurement. This low value termination resistance also improves the low frequency bandwidth of the transformer.

An added benefit of this low value is that it can generally be left in the circuit at all times, simplifying the connection to the network analyzer without appreciably impacting the output voltage of the circuit being tested.

Today’s power systems demand better measurements at both higher and lower frequencies. Engineers often use audio transformers or video transformers for signal injection purposes. This is unwise, as the low frequency performance of a video transformer is generally quite poor while both the low and high frequency performance of the audio transformer are quite poor. Many of the transformers sold as injection transformers use ferrite core materials, which are good for high frequency but relatively poor for high frequency.

The design of a transformer that has sufficient permeability at 1Hz and minimal attenuation at 10MHz or more is difficult to achieve. The core materials are specially processed and the transformers generally must be hand wound.

Most other injection transformer manufacturers use an inexpensive ferrite transformer; the price is not indicative of the cost of the transformer. The Picotest injection transformers are made of a specially annealed amorphous material in order to obtain nearly infinite permeability (>100,000). The difference in the measurement results between a Picotest transformer and another variety of transformer depends on the circuit. A switch-mode

power supply is less demanding, while an opamp or a 3 terminal regulator is more demanding. In particular, the LM317 style regulator requires the measurement to be referenced to  $V_{out}$  and not ground. In this case the transformer parasitics are much more evident.

The Picotest injection transformers are capable of an impressive 23 Octave bandwidth. This bandwidth is still not sufficient to support all requirements, and so two transformers have been designed. One is optimized for performance from 1Hz to 10MHz while the other is optimized for 10Hz to 40MHz.

Either transformer is usable for most applications. The lower frequency transformer is usable for PFC measurements, where the bandwidth is generally below 10Hz while the higher frequency transformer is usable for the newest switch-mode converters and LDO's which have bandwidths up to several MHz.

While the injection transformer is a very wideband adapter, it is not useful for measuring ripple rejection (PSRR) of a power supply or even an opamp. This is because the attributes that make the injection transformer perform so well also result in a transformer that is intolerant of DC current. Even very small DC currents (5mA or less) can greatly reduce the signal capacity or even totally saturate the transformer.

#### Connecting the Injection Transformer: Stability

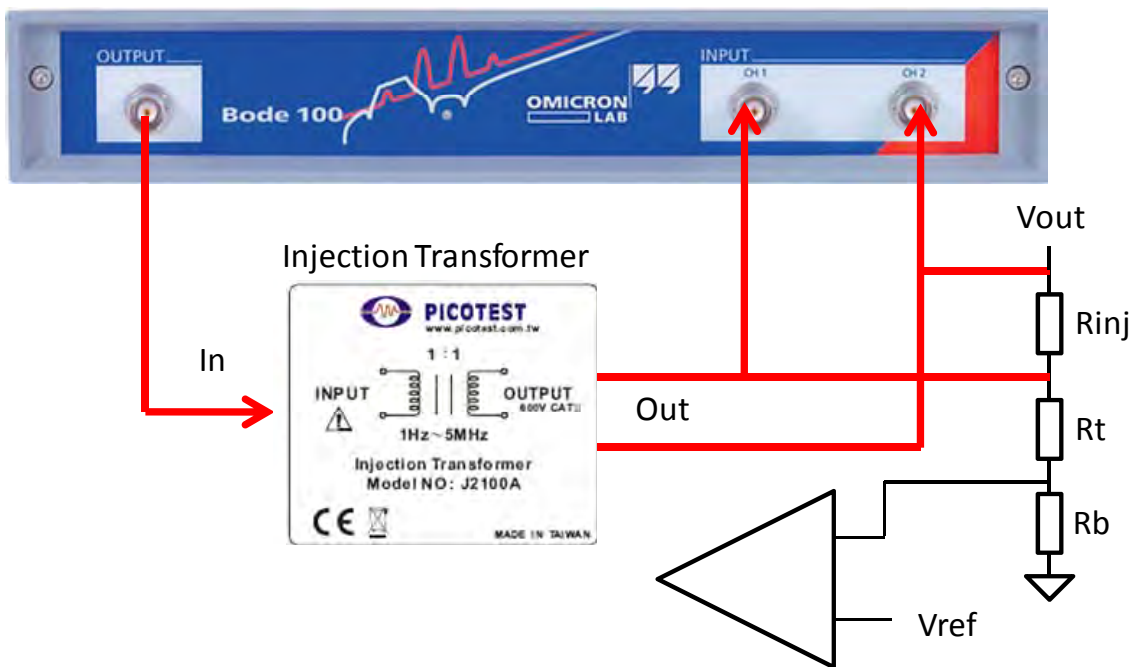
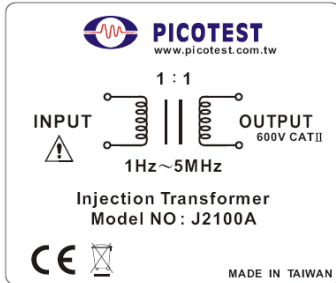

Figure 5: Injection Transformer Connections for stability measurements.

The injection transformer is connected as shown above. The output oscillator of the Bode analyzer is connected via a BNC connector to the input of the transformer. The output of the transformer is connected across the “in-circuit” injection resistor ( $R_{inj}$ ). This allows the analyzer oscillator to stimulate the loop while the loop response is recorded.

### Technical Specifications: J2100A



Characteristic	Rating	Conditions
DCR		25 degC
Ratio	1:1	
Termination Impedance	5 Ohms	
Nominal 3dB Bandwidth	10Hz - 5MHz	10mHz~100Hz, 10Hz~100MHz
Isolation Voltage	600V CAT II	3kVrms/1min
Isolation Capacitance	150pF	1kHz
DC current	10mA	DC current at which inductance(@1kHz) drops 10% (typ) from its value without current
Temperature range	0-50°C	inductance(@1kHz) / 0,50 degC
Maximum Altitude	6000 Ft	

\* Performance at -10dBm input level



Caution: To avoid equipment damage and/or severe injuries or death ensure that the absolute maximum ratings are never exceeded.

### Frequency Sweep

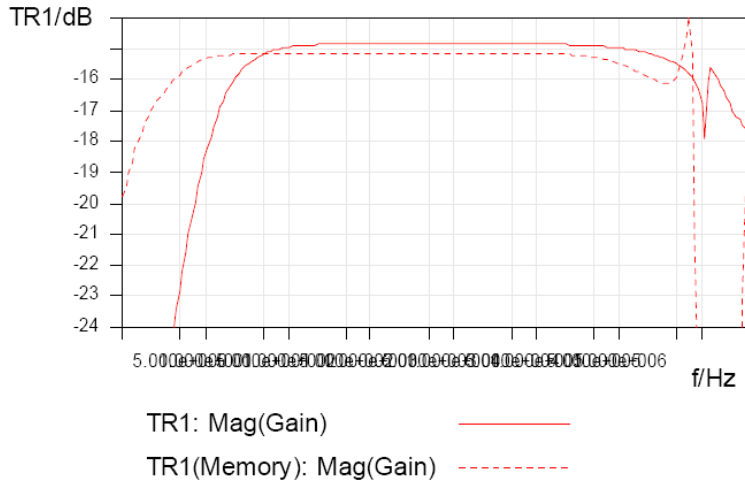
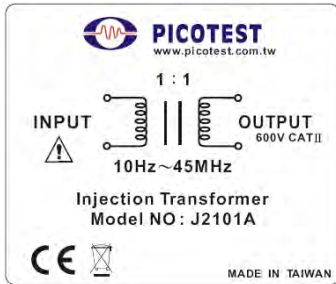

Figure 6: Frequency Response for the J2100A and J2101A injection transformer.

### Technical Specifications: J2101A



### Frequency Sweep

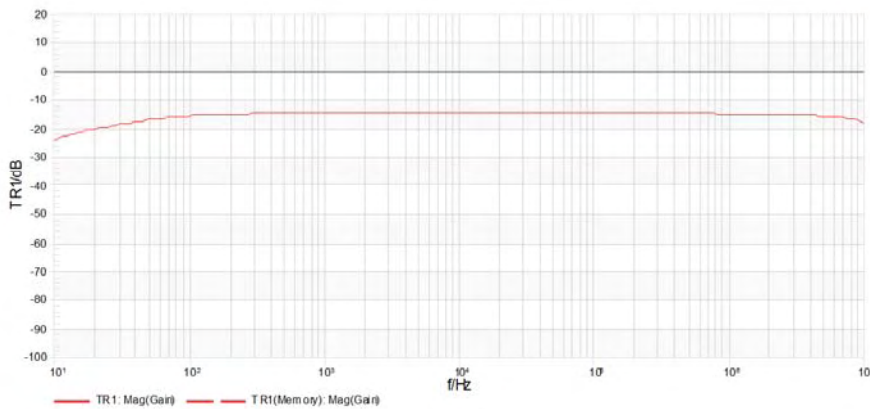

Figure 7: Frequency Response for J2101A injection transformer.

Characteristic	Rating	Conditions
DCR		25 degC
Ratio	1:1	
Termination Impedance	5 Ohms	
Nominal 3dB Bandwidth	10Hz - 5MHz	100mHz~100Hz, 10Hz~500MHz
Isolation Voltage	600V CATII	3kVrms/1min
Isolation Capacitance	150pF	1kHz
DC current	10mA	DC current at which inductance(@1kHz) drops 10% (typ) from its value without current
Temperature range	0-50°C	inductance(@1kHz) / 0,50 degC
Maximum Altitude	6000 Ft	



Caution: To avoid equipment damage and/or severe injuries or death ensure that the absolute maximum ratings are never exceeded.

## J2110A Solid State Voltage Injector

### Main Features

#### J2110A Solid State Bode Box Voltage Injector

- DC-45MHz; supports thermal and mechanical controls and highest performance regulators
- Low distortion for superior precision
- 25 Ohm insertion resistance
- 50 Ohm oscillator input
- < 3uA typical bias current
- >2 M $\Omega$  typical Input Resistance
- Includes J2170A High PSRR Low Noise Regulator with Universal input

### Description

The solid state voltage injector, or “Bode box”, is employed in the same way as the injection transformer. As noted in the introduction section, the J2110A injector has a wider bandwidth. However, the selection of a point in the circuit to insert the injection connection can be more challenging. In order to provide correct results one side of the measurement must present much higher impedance than the other side. A rule of thumb is that one side should have an impedance that is at least 50 to 100 times greater than the other. In a typical power supply control loop, the voltage sense divider is generally a good injection point, since the output impedance of the power supply is very low compared with the impedance of the voltage sense divider.

### Connecting the Solid State Injector: : Stability

The solid state injector is connected in much the same way as the injection transformer. The exception, as noted above, is that the impedance on the Vout side must be different from the Rtop side.

No injection resistor is used.

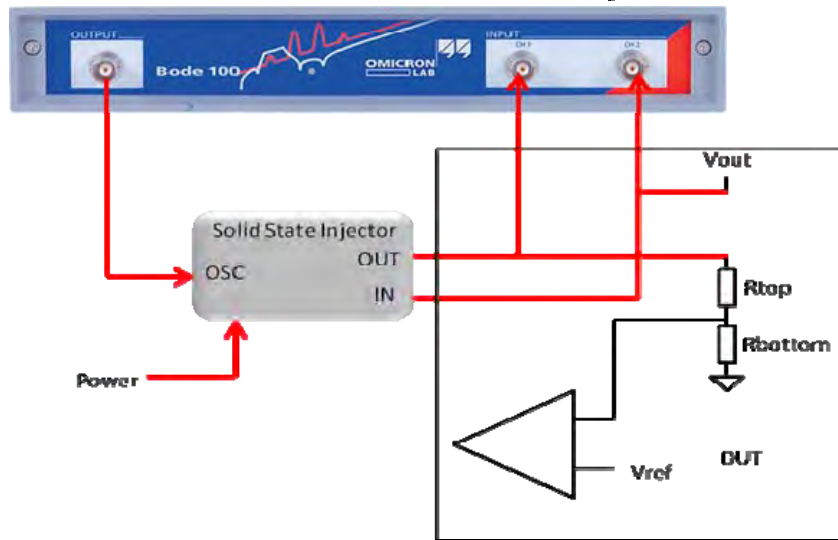
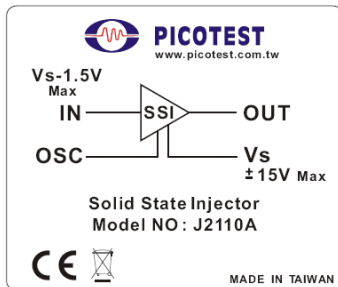

Figure 8 Solid State Injector Connections for stability measurements.

Technical Specifications



Characteristic	Rating	Conditions
Max Vs	+/-12V	25 degC
Max Icc	20mA	
Max input voltage DC+AC	+/-10.5V	
Output Voltage	+/-10.5V	
Offset Voltage	3mV	
-3dB Bandwidth (-10dBm)	DC-40MHz	
Temperature range	0-50°C	0,50 degC -3dB BW
Maximum Altitude	6000 Ft	
Absolute Maximum Voltage	<50 VAC and 75VDC	

## J2120A Line Injector

### Main Features

#### J2120A Line Injector

- 10Hz-10MHz usable bandwidth
- Low loss design
- 5 Amps maximum current
- 50VDC max input
- Easily measure input filters and PSRR

### Description

The line injector allows the input DC supply voltage to be modulated by the network analyzer source signal, as in the case of a PSRR measurement. The line injector must be capable of a frequency range well below the AC line frequency and at least above the control loop bandwidth of the circuit being tested.

### Connecting the Line Injector: PSRR

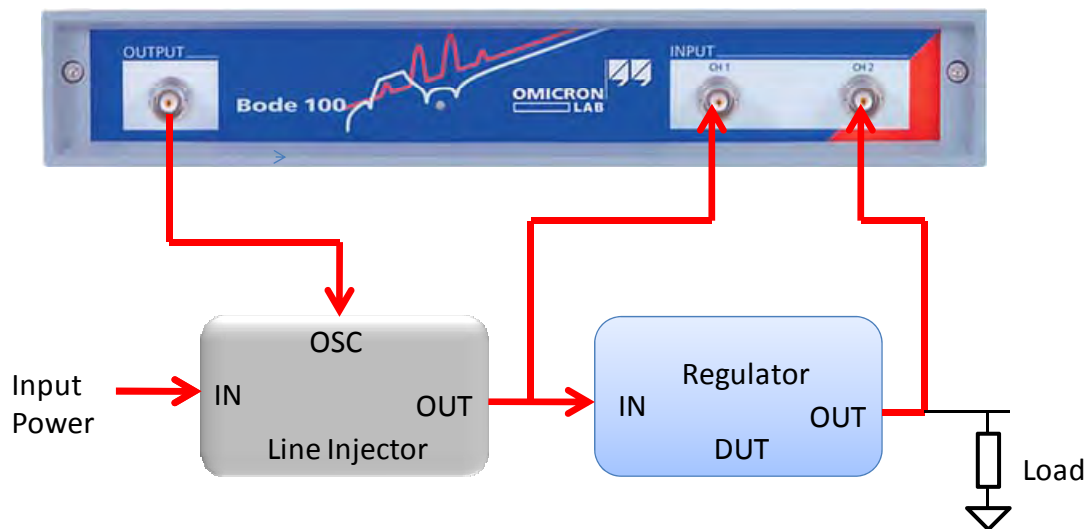

Figure 9: Line Injector Connections for PSRR measurements.

The line injector is only capable of sourcing current, so that the output amplitude can be significantly impacted by the operating current and the total storage capacitance at the load. The Bode-100 network analyzer has a very high selectivity so distortion at the output of the line injector generally does not influence the measurement. Again, this is a small signal injector, so the oscillator signals should be kept as small as possible above the noise floor. As a guide, try to keep the input signal amplitude below 50mVpp (-20dBm). In some cases



we want to attenuate the source signal even further, and so we have included the attenuators in the injector kits. Some analyzers, such as the Omicron-Lab Bode-100 allow shaping the injection amplitude as a function of frequency, which helps optimize the signal level.

### Measuring Input Impedance

The line injector can also be used in conjunction with a current probe to measure the input impedance of a power supply. The input impedance of a switching power supply or regulator is negative, which is a stability concern when combined with an EMI filter, making the measurement an important part of the design, analysis and verification process. The current probe must be set for 1A/V or the results need to be scaled accordingly for different settings.

### Connecting the Line Injector: Input Impedance

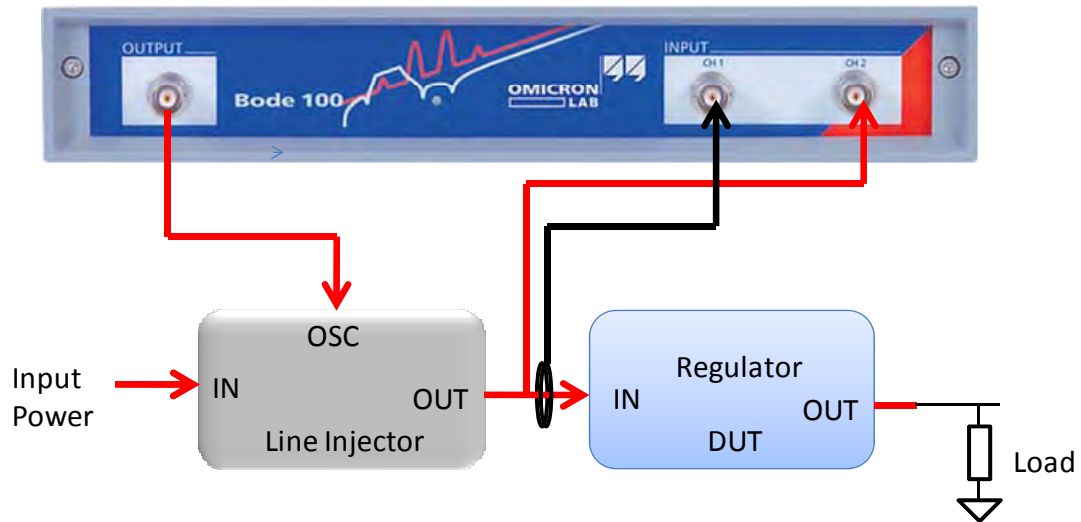
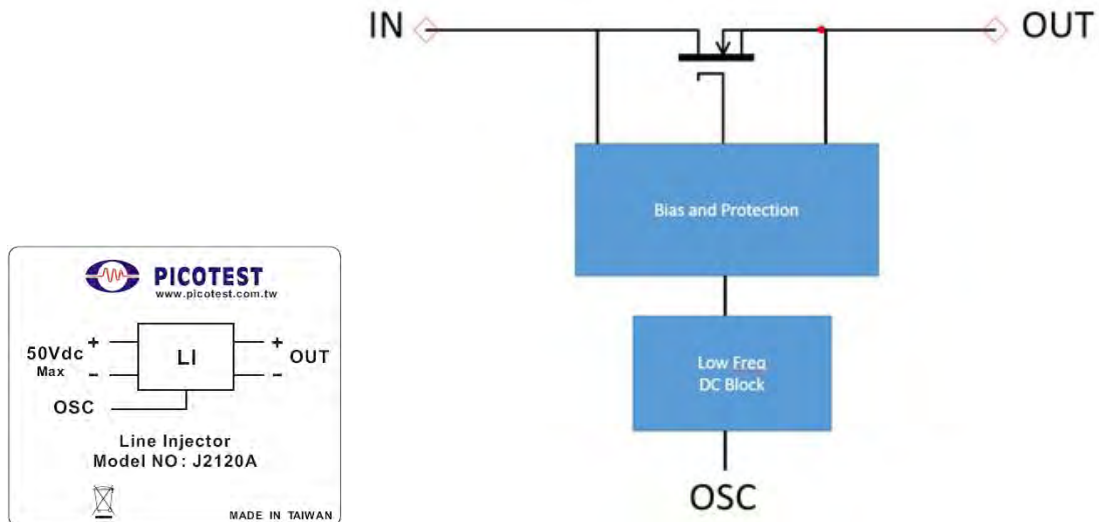

Figure 10: Line Injector Connections for input impedance measurements.

### Technical Specifications and Block Diagram



Note: The J2120A line injector includes an internally biased N-Channel Mosfet. This means that there is a voltage drop between the J2120A input and output. To get an input voltage of 1.2V at your regulator could require 2.5-3.5V depending on the operating current.

The Mosfet operates open loop so as not to become unstable when connected to the external regulator

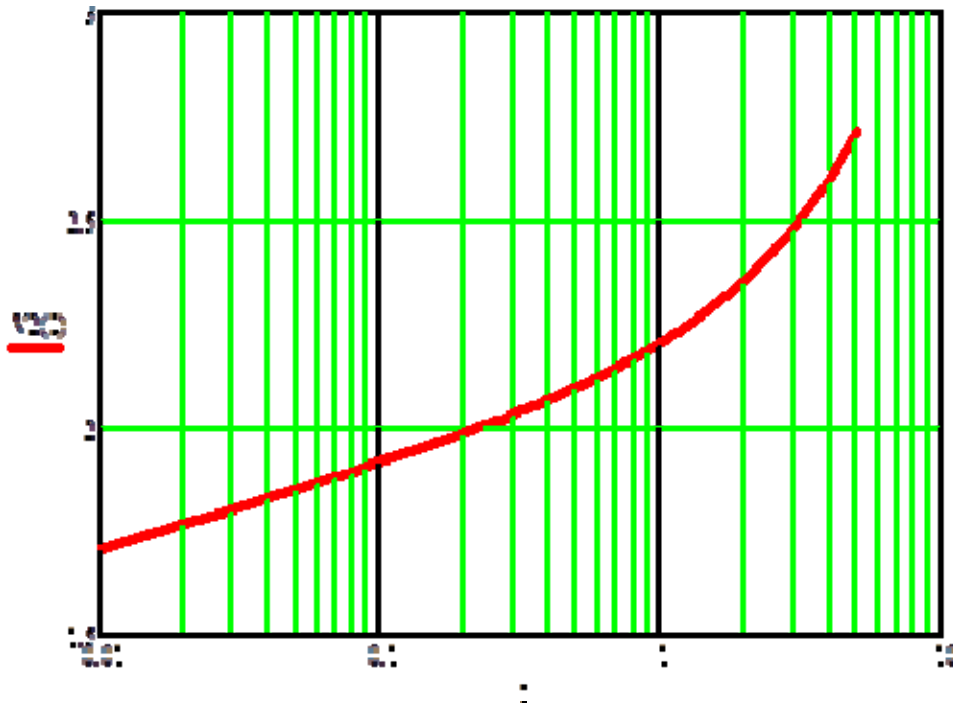

Figure 11: Line Injector voltage drop.

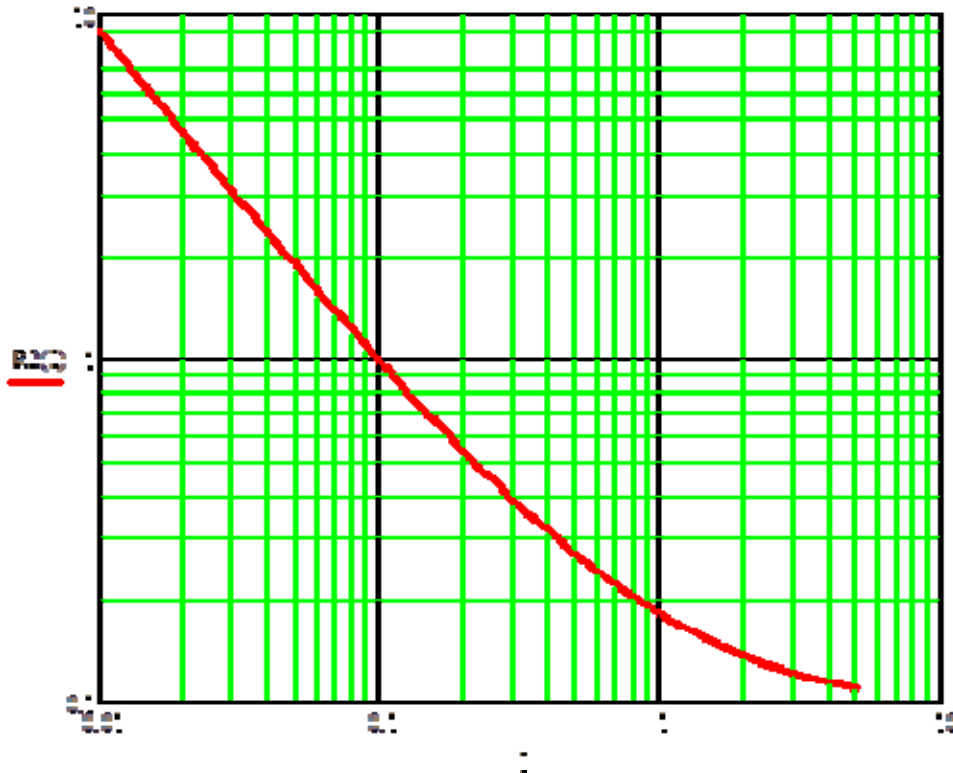

Figure 12: Line Injector output resistance.

Characteristic	Rating	Conditions
Maximum DC Input Voltage	50V	
Maximum Continuous Current	5A	
Maximum Voltage Drop	3.25V	At 5A
3dB Frequency Response	15Hz-5MHz	Vin=5V RL=50 Ohms
Useable frequency response	10Hz-10MHz	
Recommended injection signal	-20dBm-10dBm	
Temperature range	0-50°C	
Maximum Altitude	6000 Ft	
Absolute Maximum Voltage	<50 VAC and 75VDC	

## P2130A - J2130A DC Blocker/DC Bias Injector

### J2130A Main Features

#### J2130A Bias Injector

- 10Hz-10MHz usable bandwidth Low loss design
- Easily measure varactors, junction capacitance
- Measure X5R capacitor voltage sensitivity
- Bias low power transistor amplifiers and diodes for parameter extraction

### Description

The Picotest DC bias injector (J2130A) is used for applying a DC voltage bias on components during impedance measurements. The J2130A is a Resistor Capacitor Bias Tee which is useful for measuring components, such as capacitors, diodes, small signal BJTs, opto-couplers and more.

### Connecting the DC Bias Injector: Component Bias

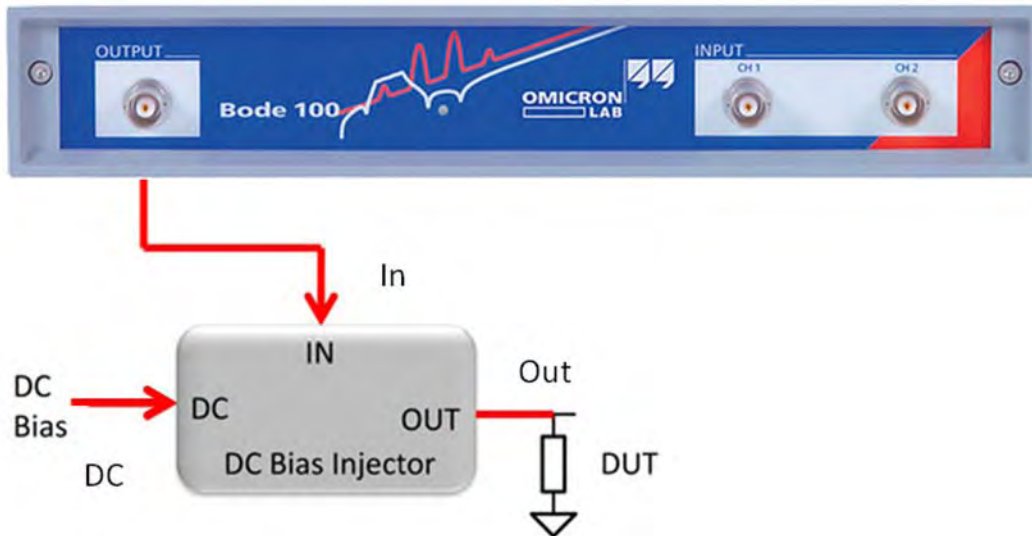
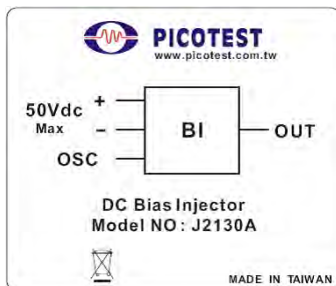

Figure 13: Connections for DC Bias Impedance measurements.

### Technical Specifications



Characteristic	Rating	Conditions
Maximum DC Bias	50VDC	
Bias Resistance	10kOhms	
Maximum Bias Current	5mA	At 50V
Frequency Response	15Hz-40MHz+	Frequency sweep 10Hz~500MHz, power=-10dBm
Temperature range	0-50°C	
Maximum Altitude	6000 Ft	
Absolute Maximum Voltage	<50 VAC and 75VDC	

### P2130A Main Features

#### P2130A DC Blocker

The P2130A is a coaxial DC blocker with SMA connectors. It is used when DC isolation is required to protect sensitive RF system components like receivers or test equipment. This DC Block lets through frequencies between 500 Hz and 6 GHz.



Figure 14: The P2130A DC blocker has a frequency response of 500Hz – 8GHz.

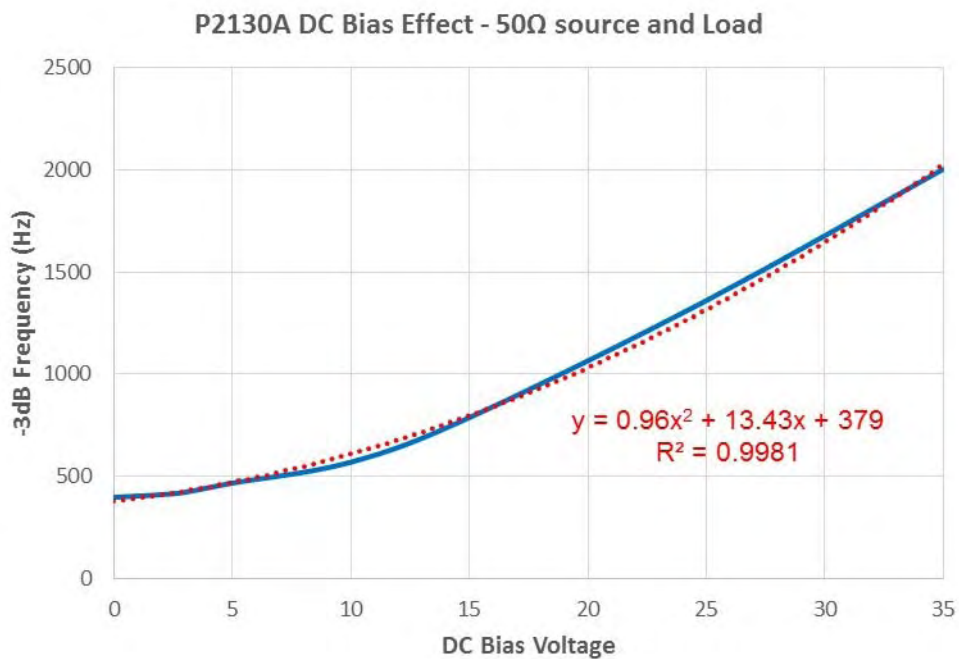

Figure 15: The effect of DC bias on the P2130A DC blocker frequency performance which shifts the - 3dB frequency.

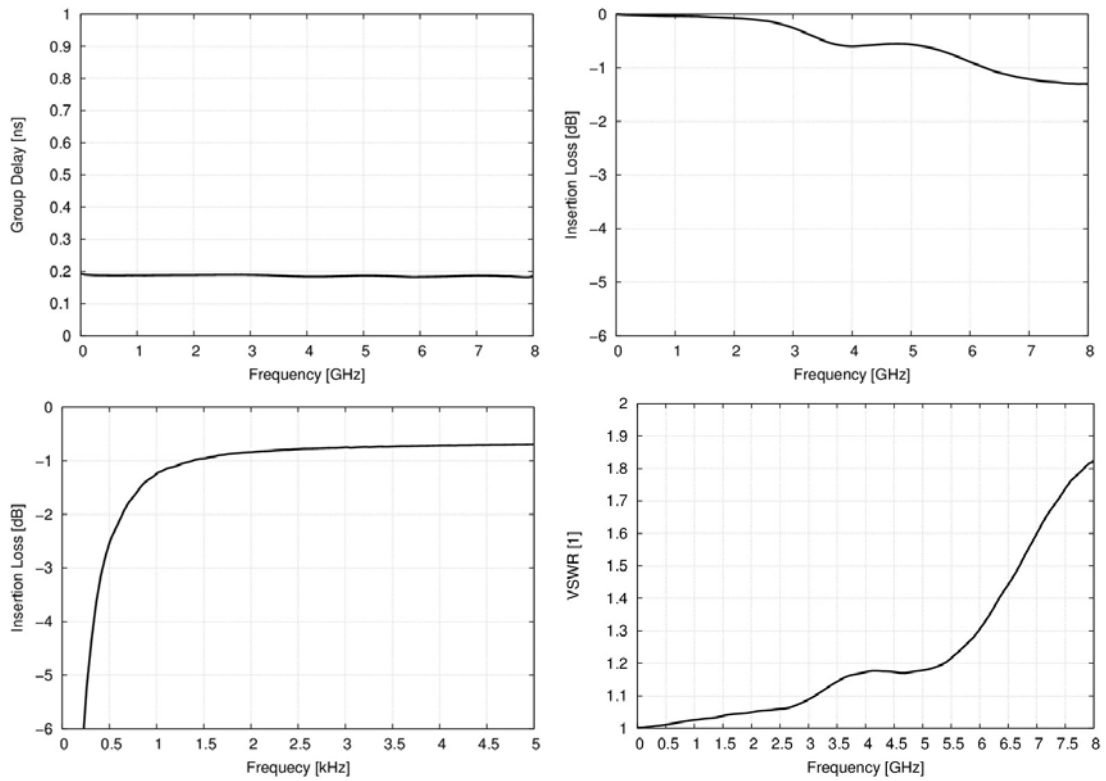

Figure 16: Electrical performance characteristics of the P2130A DC blocker.

## J2111A/J2112A Solid State Current Injector

### Main Features

#### J2111A & J2112A Solid State Current Injector

- High PSRR Low Noise Regulator with Universal input
- 20nSec typical rise and fall time
- DC-40MHz usable range (interconnection dependent)
- Two Quadrant Bipolar operation works with positive or negative source
- Build in offset for use with Network Analyzer
- Precision current monitor with 50 Ohm output
- Works with AWG, Function generator and network analyzer
- Measures Non-invasive phase margin, Output impedance, reverse transfer, crosstalk, input filter stability
- Fast transient load stepping (up to 100mA with the J2111A and 1A with the J2112A)

### Description

The current injector is one of the most versatile of the injector products. Coupled with the G5100A, or other equivalent function generator, it is capable of performing small signal load steps up to 40MHz, with very fast rising and falling edges. Using the G5100A or other AWG, also allows the rise and fall times to be controlled, various waveforms or even arbitrary waveforms. This can be used to simulate the effects of many different types of loads, including high speed digital circuit loading, which is often largely dynamic.

The current injector can also be used to measure output impedance of power supplies, voltage regulators, power buses and even batteries. It can be used to non-invasively measure the stability of a combined input filter and the negative resistance of a switching power supply. It also has application in the measurement and extraction of transistor data, including small signal current gain,  $F_t$  and many other dynamic performance parameters.

In RF and instrumentation circuits it can be used to provide constant current biasing for class A amplifiers and buffers.

The current injector has two connections for the output, Output and GND. The input is DC+AC and can be connected to either a signal generator or a network analyzer. A built in bias current enables Class A operation for use with a network analyzer. The Current Injector and DC Bias injector can also be used for this purpose.

The current injector is basically a voltage to current converter with a gain of 10mA/V for the J2111A and 200mA/V for the J2112A. For example, with the J2111A, put in a 1V signal into the modulation port and you get 10mA out of the output port and 10mV out of the current monitor port. The current injector can be controlled by the output of the network



analyzer (for frequency domain sweeps) or a function generator or arbitrary waveform generator (for time domain control and load profiling).

The J2111A is not the same as an electronic load. In many cases, the use of an electronic load will interfere with the measurement results, either due to limited bandwidth or due to high capacitance of the load and internal dampers, necessary to stabilize the load.

The J2111A is designed to provide only small signal currents, with very low capacitance and with high speed. In most cases, we prefer that the system be the load and that the J2111A be used to make measurements in an operating system as this provides the most accurate results.

The J2111A includes bias positions of -25mA, 0 and +25mA. This bias is provided as a convenience for the user (negative bias for testing negative voltages, positive bias for testing positive voltages). Since the J2111A can only sink current it is necessary to provide a bias in order to put the device into class A operation. If you do not do this, only one half of the analyzer signal would be provided, resulting in a severely distorted signal and poor accuracy. To be clear the J2111A only sinks current, not sources, and, therefore, cannot generate voltages much higher than the power supply being tested. So, for example, you cannot use it to measure a resistor as it requires a voltage source to sink current.

In cases where the 25mA is too large, it is possible to provide an external bias. The modulation input is 50 Ohms and the transconductance of the J2111A is 10mS. You can use the J2130A bias injector along with the J2111A for measuring references. This combination results in 50uA/V and at the 50V limit of the bias injector the J2111A can produce up to 2.5mA. The typical offset in the J2111A is 150uA, and it can be as high as 400uA. It is also possible to use the J2110A in conjunction with the J2111A.

The J2111A current injector is capable of SINKING 100mA while the J2112A can SINK up to 1A. The J2112A is not bilateral and can only operate from positive voltages while the J2111A can sink current from either positive or negative voltages. There is no bias switch for the J2112A as the bias is always positive 24mA.

#### **J2111A vs. the J2112A**

The J2111A is a bit more versatile than the J2112A since it is bidirectional and operates to zero current. Most engineers want to take advantage of the larger current injection capability of the J2112A. However, what they don't understand is that it is VERY difficult to drive long cable interconnect inductances at that level of current. Therefore, such large currents are usually better created by load stepper circuits directly on your PCB.

In fact, what customers should be more interested in is not large signal testing, but small signal testing for stability measurement purposes.

### J2111A – J2112A Injector Similarities

- Both injectors can be used to perform Non-Invasive Stability Measurement (getting the phase margin from an output impedance measurement)
- Both injectors can be used in the time domain for step load or load profile testing or in the frequency domain for impedance testing
- The output signals of both injectors are driven the same; from either the Bode 100 or a voltage source/AWG

### J2111A – J2112A Injector Differences

The differences are:

- The J2111A is bidirectional. It can sink or source current. The J2111A can work with positive or negative voltages
- The J2112A can only source current so it can only work with positive voltages
- The J2111A has a maximum current output of 75mA (Bias DC current of +/-25mA and 0mA, and Voltage controlled current portion of 50mA)
- The J2111A has a voltage to current scaling 1V/10mA (10mA/V scaling)
- The J2112A has a maximum current output of 1A (minimum output current of 24mA)
- The J2112A has a voltage to current scaling 1V/200mA (200mA/V scaling)
- The J2111A goes to 40MHz (about 20ns edges, but this will be dependent upon the interconnect inductance)
- The J2112A goes to 50MHz (about 10ns edges possible, but this will be dependent upon the interconnect inductance)

### Basic Operation of the Current Injector and Other FAQs

If you are measuring negative regulators the negative voltage goes to the red jack and ground goes to the black jack, just as if it were positive. For negative regulators a modulation voltage of zero is Zero amps and -5V is -50mA. For positive regulators a modulation of zero volts is zero amps and +5V is 50mA. The transconductance is 10ms, so 10mA/Volt.

The bias switch can bias the positive regulator 25mA (+bias position) and the negative regulator -25mA (-bias position).

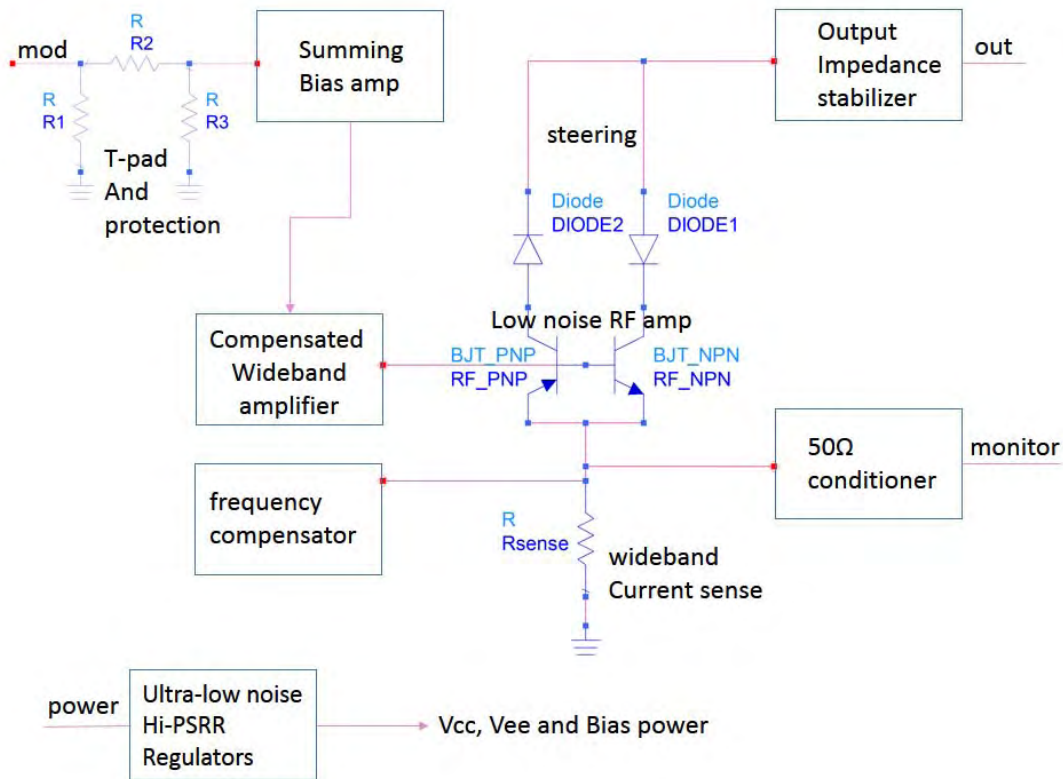

Figure 17: Current Injector internal block diagram.

### Connecting the Current Injector Example: Output Impedance VNA measurement

For an output impedance measurement you need to connect the output of the current injector using a scope probe (preferably 1X for best sensitivity) from the VNA to the output of your regulator.

You would connect the scope probe to the “T” input (terminated into 1M $\Omega$ ) and the current monitor from the current injector to the “R” input (terminated into 50  $\Omega$ ). The LF Output connects to the modulator input of the current injector. This is all shown below in the connection diagram.

There is also a bias switch on the current injector that needs to be switched to the “+” position for positive (voltage) regulator measurements.

The sweep frequency should be from 100Hz to 10MHz and a signal injection level of 0dBm is a good place to start for signal level. We would also recommend using a low receiver bandwidth or IF Frequency (at most 100Hz).

For the number of points per decade in the sweep, we typically use 401. Going higher than that is not a problem, but potentially unnecessary. Should the peak in impedance at the

bandwidth of the regulator be so steep that it appears to be aliased or truncated, increasing the number of points per decade and/or narrowing the frequency sweep span around that peak will help improve the accuracy.

Plot the magnitude ( $|Z|$ ) and group delay ( $T_g$ ) on 2 grids since when using 2 traces on the same grid only one axis is displayed at a time (corresponding to whichever trace is selected).

To do a small signal load step you would change the modulator from the network analyzer to an AWG and change the bias switch on the current injector from the “+” position to the middle position (no bias current). The scope probe and current monitor would then go to an oscilloscope. Now generate a square voltage pulse with the AWG and this will present itself as a square load pulse at the output of the regulator. The scaling for the AWG voltage to load current transformation is 100:1, meaning a 0 to 1V pulse would represent a 0 to 10mA load step.

Make sure the current monitor is terminated into 50 Ohms and that the voltage waveform is AC coupled so as to best see the voltage response at the output of the device. I find it easiest to trigger off of the “Sync” output of the AWG, however, syncing off of the load current pulse will also work.

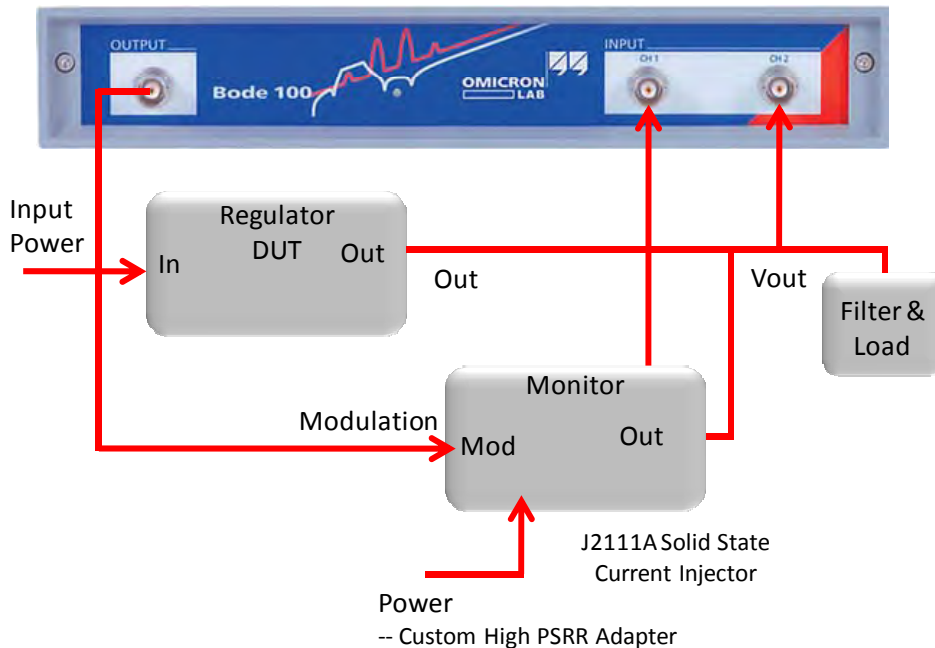
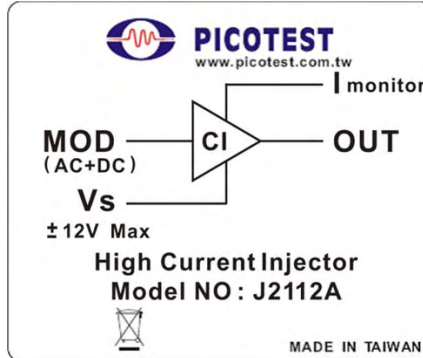
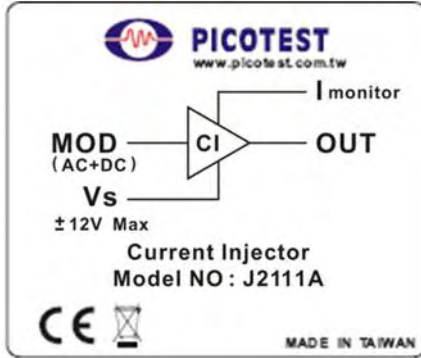

Figure 18: Current Injector Connections for output impedance measurements.

### Technical Specifications



Characteristic	J2111A Rating	J2112A Rating
Max input voltage DC+AC	+/-5V	+5V
Maximum Output Current	+/-74mA	+1A
Minimum Output Current	0A	24mA
Max Output Voltage	40V	10.5V
Current Monitor	1V/A	0.1V/A
Modulator Gain	10mA/V	200mA/V
Offset Current (typical)	+/-24mA	+24mA
Usable Bandwidth	DC-40MHz	DC-40MHz
Temperature range	0-50°C	0-50°C
Maximum Altitude	6000 Ft	6000 Ft
Absolute Maximum Voltage	<50 VAC and 75VDC	<50 VAC and 75VDC

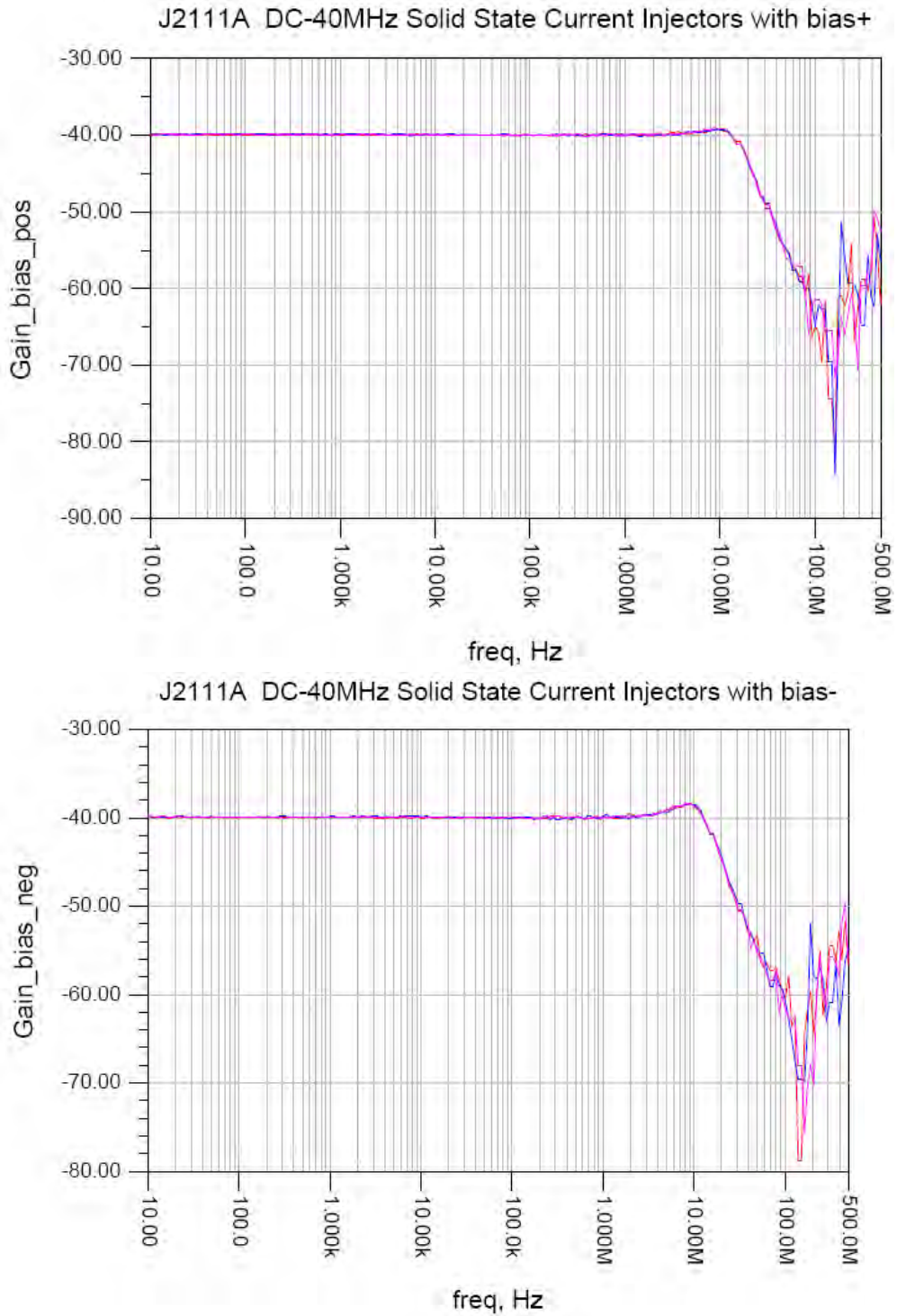

Figure 19: J2111A frequency response.

## J2170A High PSRR Power Supply Adapter

### Main Features

#### J2170A Power Supply for J2110A and J2111A

- Universal input voltage 100V-240V
- +/-12V 40mA output
- Very low output impedance (see below)
- Very low noise (have not measured, nor do we have the capability to)
- Ultra high PSRR (see below)

### Description

The J2170A power adapter is specially designed for use with the Picotest J2110A and J2111A signal injector products. The supply combines a universal worldwide input (100 to 240 VAC ) with two high performance linear regulators.

While there are many off-the-shelf power supplies available that can provide a universal input voltage and 12V output voltage, they do not provide the same performance as the J2170A. Most switching regulators produce significant ripple at and above 100kHz. This ripple passes through the PSRR of the internal opamps, reducing the noise floor. While this may work in many applications, it is less than ideal. Typical switching power supplies and even typical linear regulators have a high output impedance at 40MHz, due to the ESL of the output capacitors and the nature of the control loop.

The J2170A uses a discrete design approach, offering very low output impedance, stable performance with large ceramic decoupling capacitors and ultra high PSRR compared with typical off-the-shelf devices. To maintain a good noise floor for various measurements, the power supply must have very low noise.

Characteristic	Rating	Conditions
Absolute Maximum Input Voltage	240V	60Hz
Output Voltage	+/-12V	
Maximum Icc	50mA	
Temperature range	0-50°C	

## J2140A Attenuators

### Main Features

#### J2140A Attenuator

- Integrated unit includes 20dB, 40dB and 60dB
- Cascade for greater attenuation
- Improve noise floor or assure small signal measurement

### Description

There are two common uses for attenuators when used in conjunction with the network analyzer. One is to attenuate the oscillator source signal. While this may seem odd, one of the most common errors in analyzer measurements is using a source signal that is too large. Even though the analyzer allows setting of the signal output amplitude, the lowest setting is often too high to allow an accurate small-signal measurement to be made. The correct amplitude is the smallest amplitude that exceeds the noise floor.

Attenuators are also useful for improving the dynamic range of the measurement. In some cases, as in measuring the open loop gain of an opamp as one example, the low frequency loop gain will be extremely large (100dB or more is not uncommon). Attenuating the output signal increases the effective range of the measurement.

### Technical Specifications

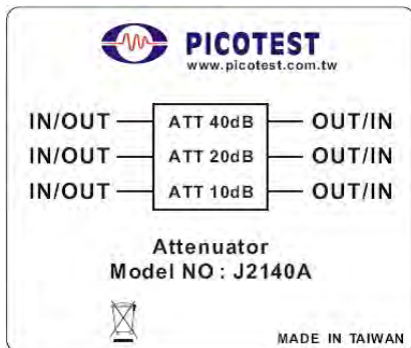

Characteristic	Rating
Maximum input level	+20dBm
3dB Frequency Range	DC-50MHz
Maximum VSWR	1.3
Attenuation accuracy	0.2 dB
Absolute Maximum Voltage	<50 VAC and 75VDC



## Frequency Sweep

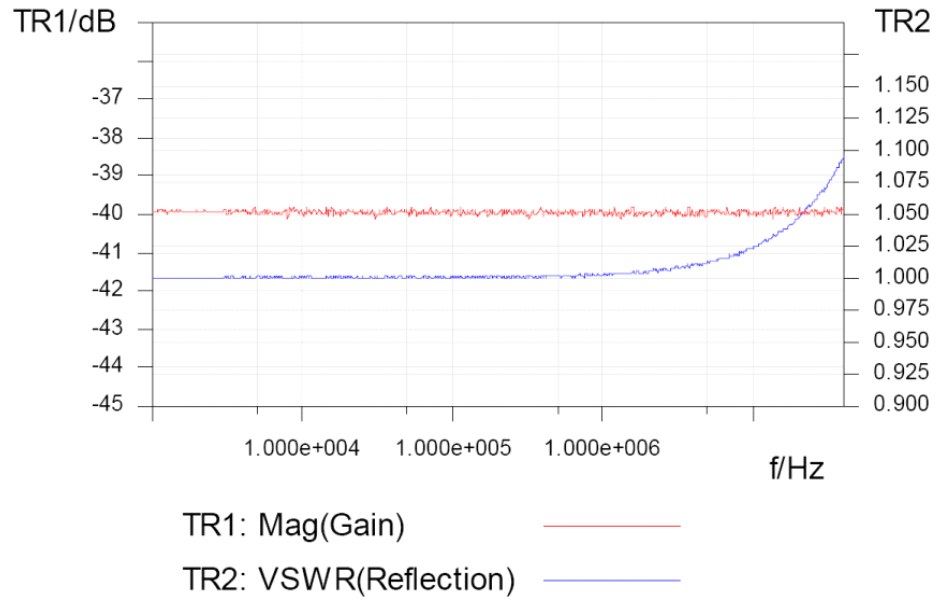

Figure 20: 40dB attenuator frequency response.

## J2180A 0.1Hz to 100MHz Ultra Low Noise Preamp

### Main Features

#### J2180A 0.1Hz to 100MHz Ultra Low Noise Preamp

- Works with all oscilloscopes, spectrum analyzers and network analyzers
- Active DC bias loop maintains low DC output voltage
- High input impedance compatible with typical probes minimizes circuit loading
- Ultra low noise
- Works with near field probes for EMI troubleshooting
- Improves effective noise floor and spurious response
- Very wide bandwidth (0.1Hz – 100MHz)
- Compatible with J2170A power supply

### Description

The J2180A low noise preamplifier provides a fixed, AC coupled 20dB gain while converting a 1 MegOhm input impedance to a 50 Ohm output impedance. With a 3dB bandwidth of 0.1Hz to 100MHz, the preamplifier improves the sensitivity of oscilloscopes, network analyzers and spectrum analyzers while reducing the effective noise floor and spurious response. The preamplifier can also serve as a low frequency DC blocker for a spectrum analyzer or you can use it to connect a high input impedance oscilloscope probe to 50 Ohm equipment.

The J2180A preamplifier offers very low noise, fast 100V/uS slew rate for pulse applications and very low distortion for audio applications.

**Connecting the Preamp: EMI and Noise Measurements**

Figure 21: Sample setups for the J2180A Preamp used for noise and EMI measurements.

### Technical Specifications



Characteristic	Rating
Maximum Vcc	+/-12V
Maximum Input Voltage	300mVpp
Output Voltage	3.0Vpp
Maximum Icc	20mA
Usable Bandwidth	0.1Hz - 100MHz
Temperature range	0-50°C
Absolute Maximum Voltage	<50 VAC and 75VDC

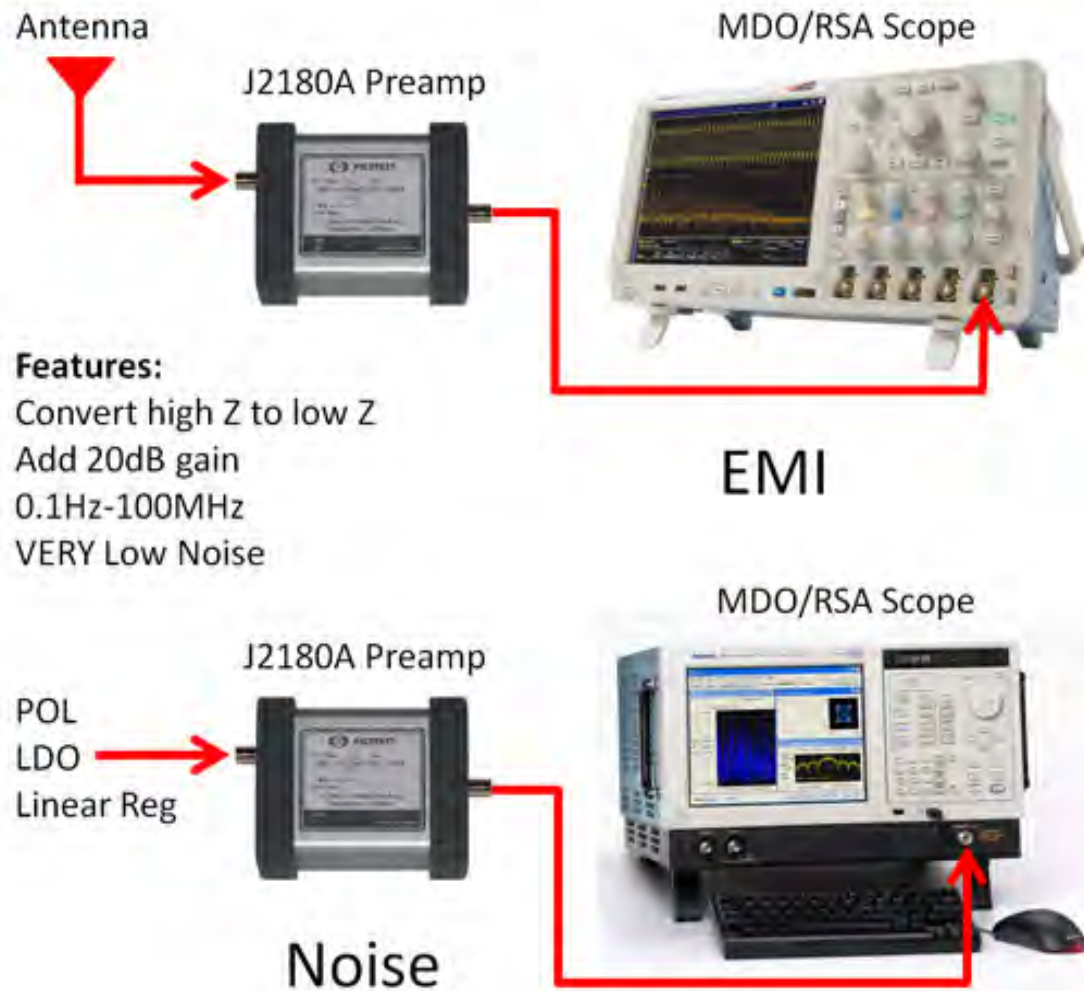
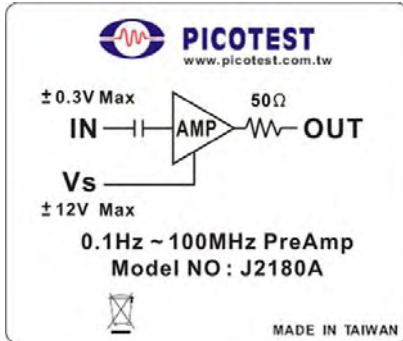
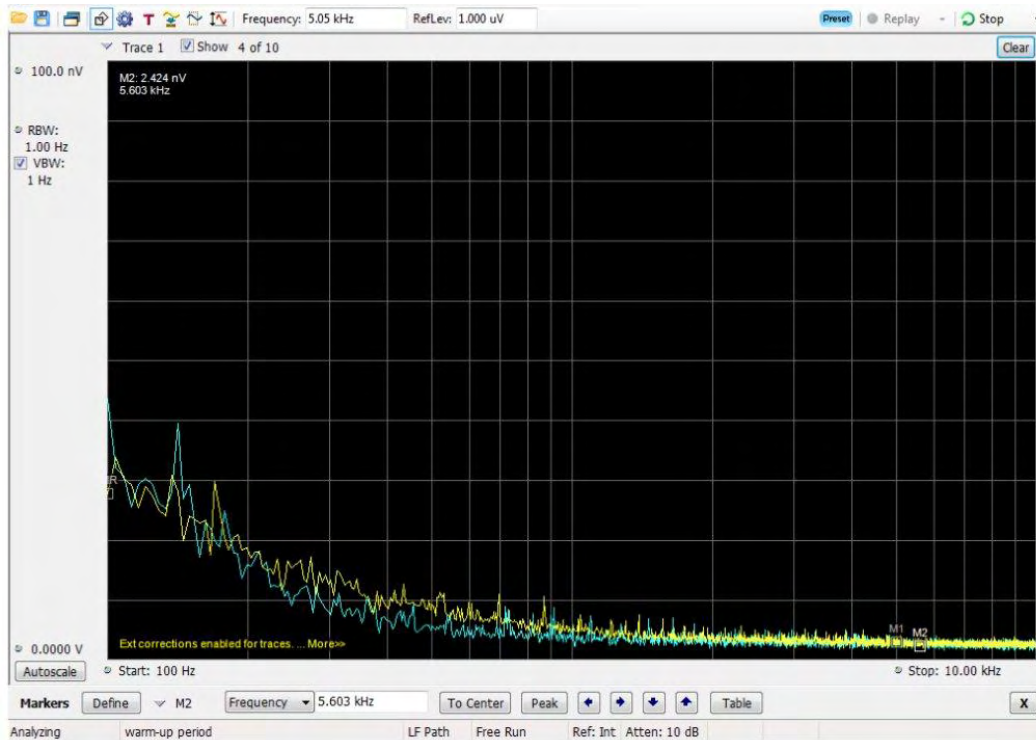

Figure 22: Noise Density 100nV full scale, mid range noise density is 2nV/Root-Hz.

## J2190A 0.1Hz to 10Hz Active Filter

### Main Features

#### J2190A 0.1Hz to 10Hz Active Filter

- 0.1Hz to 10Hz 4<sup>th</sup> Order Filter
- Ultra low noise
- Cascadable with additional filters
- Compatible with J2170A power supply

### Description

The J2190A active filter presents a high impedance (approximately 150kOhms) minimizing the loading of the circuit being tested. The output impedance is 50 Ohms allowing low noise coaxial connections to all typical test equipment. The 0.1Hz-10Hz noise band is common for opamp measurements, voltage regulators and voltage references. Many application notes offer schematics of such a filter for test purposes. An engineer's time is much too valuable to be spent building test equipment. We have created a 4th order high pass and 4th order low pass filter with an optimally flat response and 0dB gain. Additional filters can be cascaded for even sharper cutoff.

The J2190A is not a programmable filter, though it is easily customizable to a particular noise bandwidth and/or circuit gain.

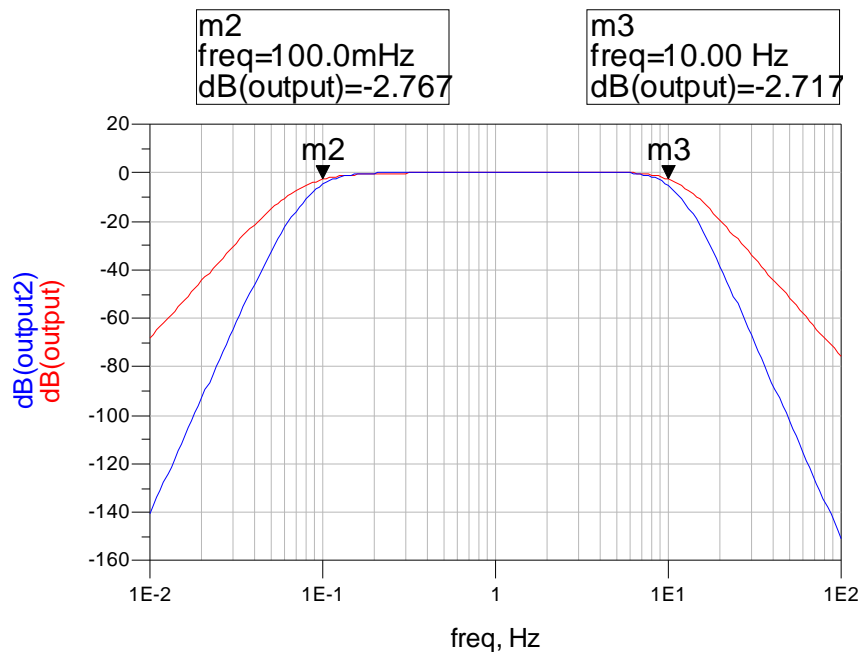
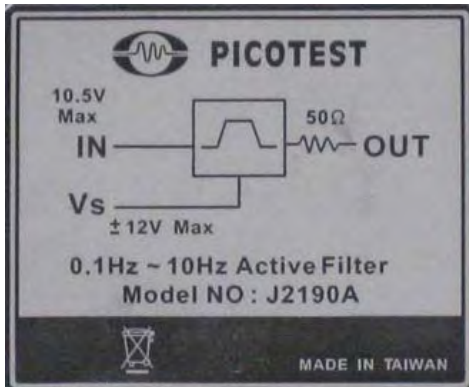

Figure 23: Frequency response of a single filter (red trace) and 2 cascaded filters (blue trace).



Characteristic	Rating
Gain	0 dB
Noise	
Input Impedance	High
Output Impedance	50 ohms
Bandwidth	0.1Hz – 10Hz
Temperature Range	0 – 50C
Maximum Altitude	6000
Absolute Maximum Voltage	<50 VAC and 75VDC

## J2102A Common Mode Transformer

### Main Features

- Greatly attenuates the effects of low frequency ground loops
- Supports the 2 Port Shunt Thru impedance measurement required for Power Distribution Networks (PDN's)
- Maintains 50 Ohm transmission line integrity to approximately 500MHz
- Works with all types of test equipment to eliminate ground loops, such as Network Analyzers, Oscilloscopes and Spectrum Analyzers

### Description

It is difficult for conventional low frequency network analyzers with grounded receivers to measure a  $m\Omega$  shunt impedance in the low-frequency range, because the measurement error is caused by the test cable ground loop between the source and receiver. Generally, this problem occurs in the low-frequency range below 100 kHz, which is an essential frequency range for evaluating the impedance of DC-DC converters and bulk bypass capacitors. The simplest and most effective solution for eliminating a ground loop is to add a wideband common mode transformer to the measurement, such as the Picotest J2102A Common Mode Transformer. The transformer for a low impedance PDN measurement must have very wide bandwidth, low loss and tight coupling; otherwise, the results will not be accurate over the measured frequency range. It is also important to maintain the 50 Ohm transmission line impedance through this transformer. The J2102A accomplishes this.

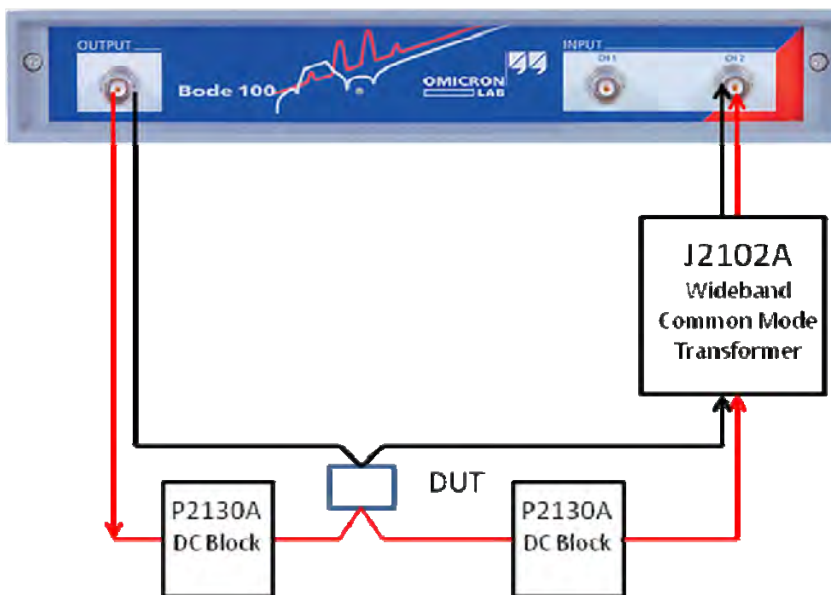

Figure 24: Connection diagram showing the placement of the J2102A common mode transformer. Inclusion of the transformer eliminates the low frequency distortion caused by

instrumentation ground loops.

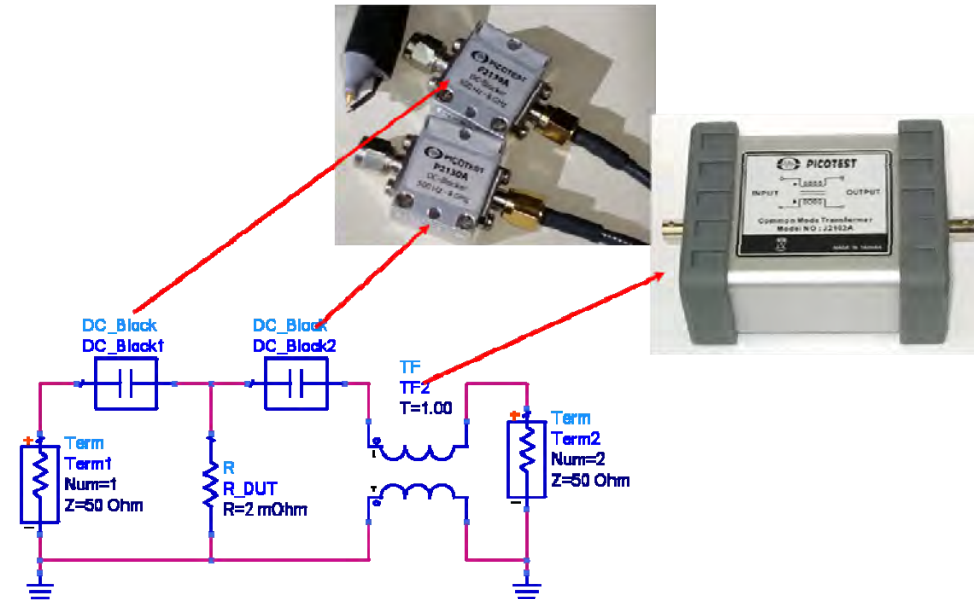

Figure 25: Electrical connection diagram showing the placement of the J2102A and P2130A DC blockers for a 2 port shunt impedance measurement.

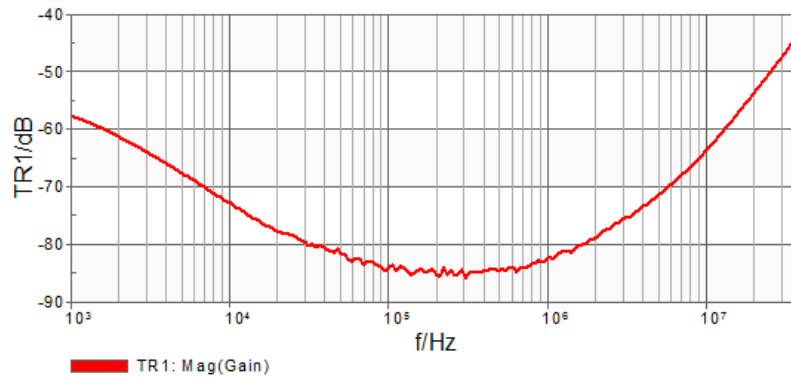

Figure 26: Frequency response of the J2102A.



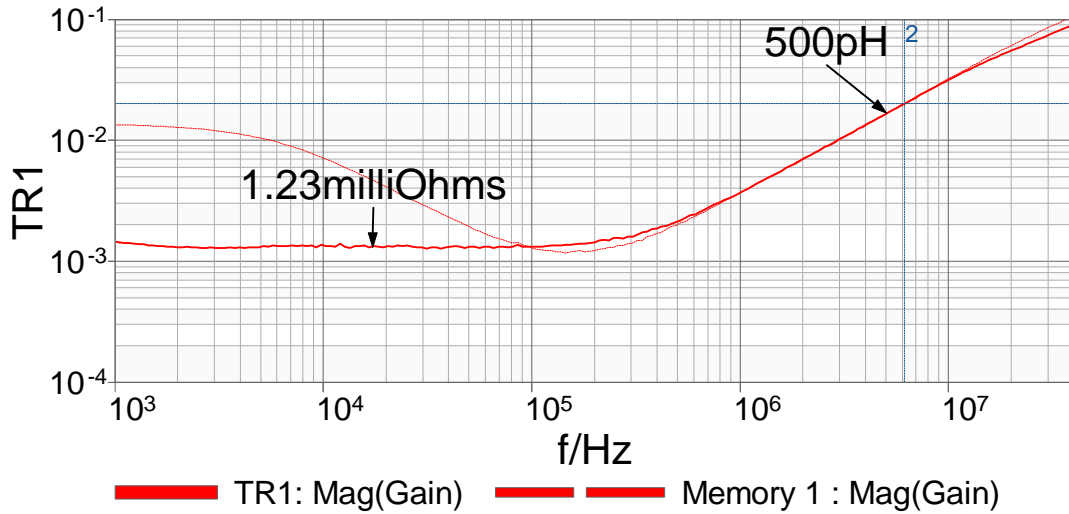

Figure 27: Impedance measurement of a  $1\text{m}\Omega$  resistor with and without the J2102A common mode transformer using the OMICRON Lab Bode 100.

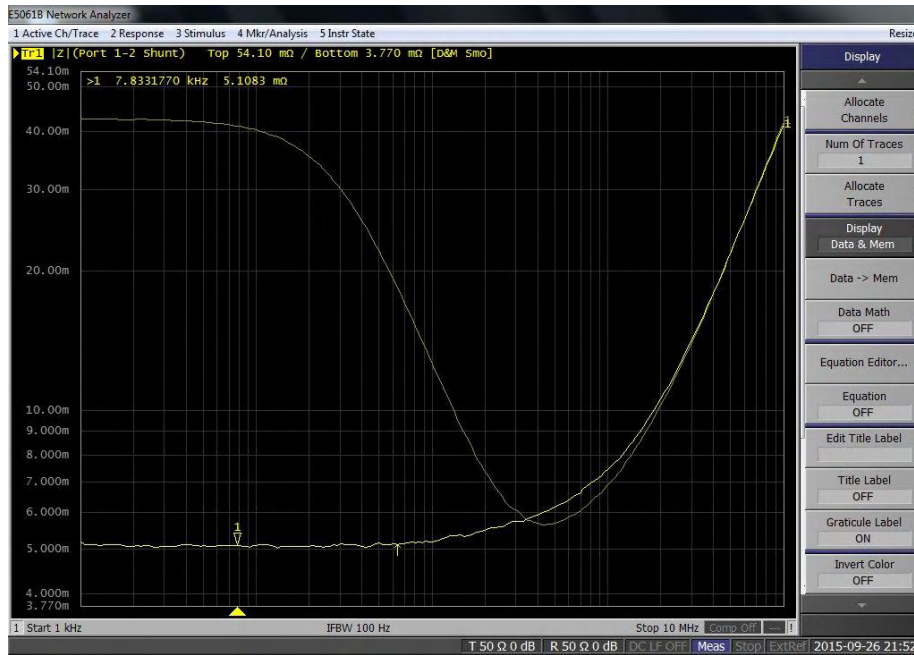

Figure 28: Impedance measurement of a  $5\text{m}\Omega$  resistor with and without the J2102A common mode transformer using the Keysight E5061B.

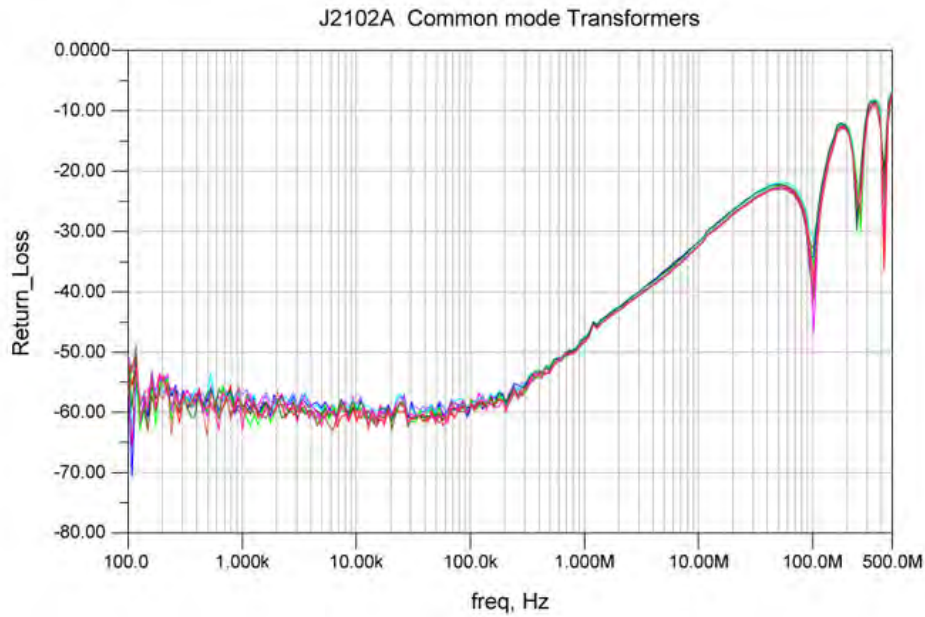

Figure 29: J2102A Return Loss Graph.

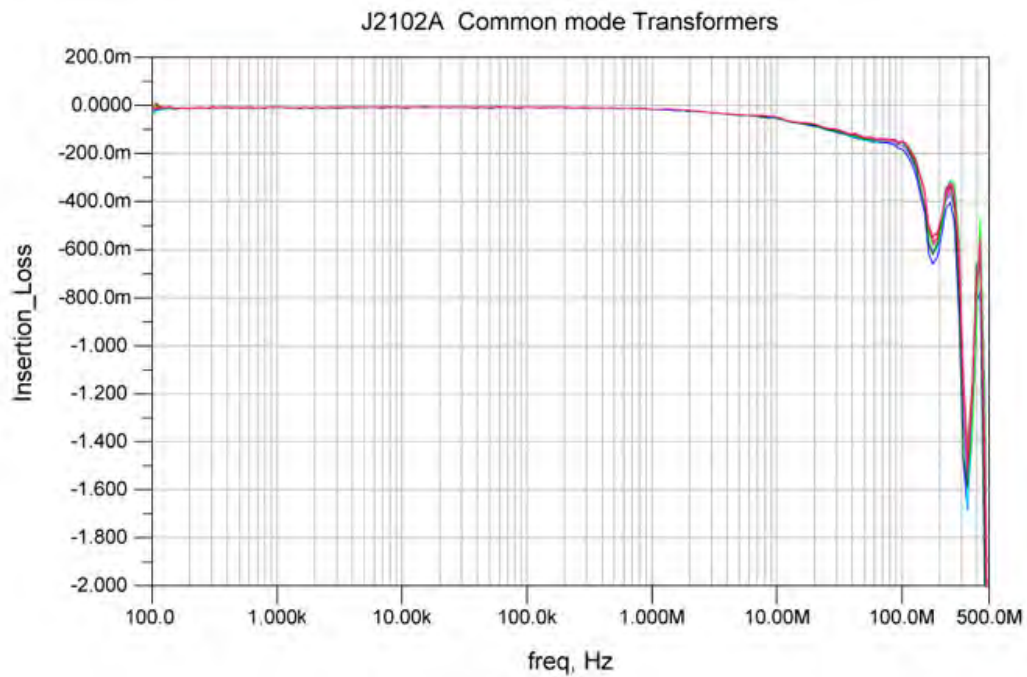
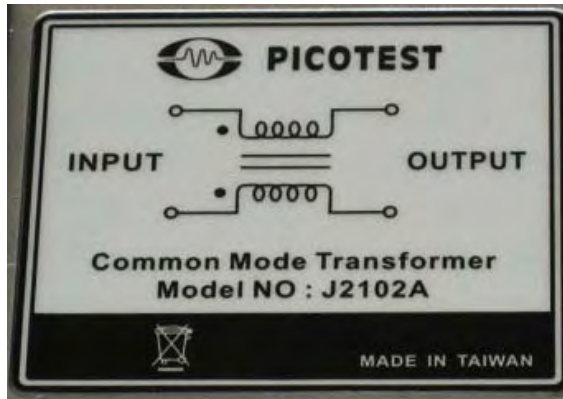

Figure 30: J2102A Insertion Loss Graph.

### Technical Specifications



Characteristic	Rating
Recommended Bandwidth	1Hz-100MHz
Insertion Loss	1Hz-100MHz 0.2dB typical, 0.5dB max
Return Loss	1Hz-100MHz 20dB typical, 10dB min
Max voltage	50v
Temperature range	0-50C
Maximum Altitude	6000 Ft
Absolute Maximum Voltage	<50 VAC and 75VDC

## Injector Input/Output Impedances

<b>J2110A</b>	<b>Impedance</b>
Modulation Input	50 Ohms
Output	25 Ohms
Input	High Z
<b>J2111A</b>	
Modulation Input	50 Ohms
Current Monitor Output	50 Ohms
<b>J2120A</b>	
Modulation Input	10K Ohms
<b>J2140A</b>	
Input	50 Ohms
Output	50 Ohms
<b>J2180A</b>	
Input	High Z
Output	50 Ohms
<b>J2190A</b>	
Input	High Z
Output	50 Ohms
<b>J2112A</b>	
Modulation Input	50 Ohms
Current Monitor Output	50 Ohms
<b>J2102A</b>	
Input	50 Ohms
Output	50 Ohms