

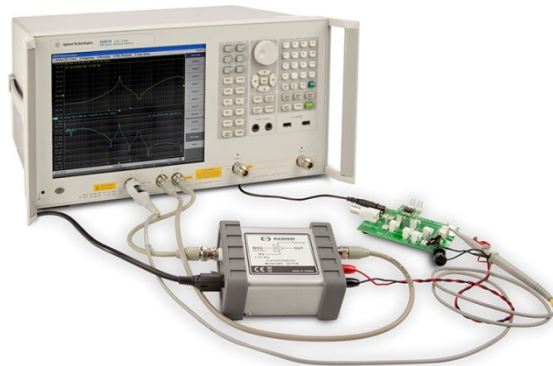

Non-Invasive Stability Margin Measurement

For the Keysight E5061B and E5071C and
Rhode & Schwarz ZNL/ZNLE



Documentation

Version 1.6, 2019

Copyright © 2016-2019 Picotest

All Rights Reserved

Trademarks

The Picotest logo and “Picotest Injectors” are trademarks of Picotest Corp.

Rohde & Schwarz, the Rohde & Schwarz Logo, Keysight, the Keysight Logo, the ZNL, ZNLE, E5061B, and the E5071C are trademarks or registered trademarks of their respective owners.

All other brand and product names mentioned herein are used for identification purposes only and are registered trademarks, trademarks, or service marks of their respective holders.

Copyright notice

Except as permitted under the United States Copyright Act of 1976, no part of this publication may be reproduced or distributed in any form or by any means, or stored in a data base or retrieval system, without the prior written permission of Picotest Corp.

Contact information

Corporate offices	1-877 914-PICO
Technical support e-mail	info@picotest.com
World Wide Web	https://www.picotest.com

Table of Contents

Chapter 1 - Overview	4
Welcome	4
What's Included	5
Documentation and Support	5
Chapter 2 –Measuring Non-Invasive Stability (Phase) Margin	6
Introduction.....	6
Installing and Running the Software - Keysight	8
Making Non-Invasive Stability Measurements - Keysight.....	8
Saving Data.....	17
Installing and Running the Software – Rohde & Schwarz	17
Making Non-Invasive Stability Measurements - Rohde & Schwarz	19
Chapter 3 - Examples	26
Example 1– T Over R Measurement.....	26
Example 2 – 1Port – 2Port Measurement	33
Example 3– 1-Port Measurement	39
Example 3– 2-Port Shunt-Through Measurement.....	41

Chapter 1 - Overview

Welcome

Thank you for purchasing the Picotest Non-Invasive Stability Measurement ('NISM') software product.

Summary of Benefits:

- Measure the stability margin of all types of control loops
- Ability to determine stability margin of regulators, switchers, POLs, and opamps, even if the control loop is not accessible or exposed outside of the device.
- Ability to find the phase margin of regulators and switchers that have multiple loops; even if one or more of those loops are internal to the device.
- Ability to derive the phase or stability margin from output impedance measurements
- Easily perform the Non-Invasive Stability Measurement on the Keysight E5061B, E5071C ENAs, or the Rohde & Schwarz ZNL/ZNLE VNAs.

What's Included

Your Picotest Non-Invasive Stability Margin software is available in one of the following configurations:

- Option 1 –Software only –Non-invasive Stability Margin software
- Option 2 –Option 1 Non-Invasive Stability Measurement Software with one Picotest 1-Port PDN Probe and one DC blocker. Probe accessory kit included.
- Option 3 –Option 2 Non-Invasive Stability Measurement Software with one Picotest 1-Port PDN Probe, one 2-Port PDN Probe, and one DC blocker. Probe accessory kit included.

Specific NISM software versions are available for the Keysight E5061B and the E5071C and the R&S ZNL and ZNLE instruments.

Documentation and Support

This documentation details the use of the Non-Invasive Stability Measurement software. Details on the use of the Picotest 1-Port or 2-Port PDN probes are available at https://www.picotest.com/products_PDN_Probe.html.

The support section of Picotest's web site, <https://www.picotest.com/support.html>, contains additional documentation and various publications on testing power supplies, regulators, and other equipment using Picotest products.

Chapter 2 –Measuring Non-Invasive Stability (Phase) Margin

Introduction

The Non-Invasive Stability Margin Measurement is performed by a licensed software program that uses proprietary mathematical conversion algorithms, based on minor loop gain. The conversion transforms impedance, normally output impedance, and the associated group delay waveform into phase margin.

Keysight E5061B Notes

For the E5061B, a 'nism' file folder is provided with several files (VBA, EXE, STA, etc.). The measurement macro used by the instrument is called NISM.VBA.

NISM.VBA–Works with the 2-port shunt thru measurement using the low frequency T/R Gain-Phase analyzer and both the 1-port (S11 reflection) and 2-port (S21 shunt thru) measurements using the high frequency channel (Port 1 and Port 2).

Please note that the low frequency T/R channel does not require a common mode coaxial transformer, since these inputs are semi-floating in the E5061B. A common mode coaxial transformer is required when using the high frequency channels of the E5061B. The Picotest J2102B is made for this purpose.

Keysight E5071C Notes

For the E5071C, one macro is provided since the same macro works with 1 or 2 port impedance measurements.

The file is called E5071CNISM.VBA.

E5071CNISM.VBA– Works with both the 1-port (S11 reflection) and 2-port (S21 shunt thru) measurements using any combination of the high frequency channels (Ports 1-Port 4).

A common mode coaxial transformer may be required when using the E5071C (in order to attenuates the effects of low frequency ground loops when making 2-Port shunt thru impedance measurements). The Picotest J2102B (www.picotest.com/products_J2102B.html) is made for this purpose.

R&S ZNL Notes

For the R&S VNAs, there is a software installer which installs a 'nism' file folder on the instrument with several files. Currently the ZNL and the ZNLE support NISM.

Installing and Running the Software - Keysight

For the Keysight E5061B/E5071C

To install and run the NISM software:

1. Install and run the VBA macro files by first copying the 'nism' folder to the analyzer's D:/ drive. You must copy the entire folder.

You may have to unzip the nism folder if the software was shipped via email in a zip file. In some cases, due to email system constraints, the zip file may need to be renamed from nism.txt to nism.zip, before being unzipped.

2. Press [Macro Setup], (Load Project), and load the macro NISM.VBA. Press [Macro Run] to run the macro.

Making Non-Invasive Stability Measurements - Keysight

Instructions on running the software are shown below.

PLEASE NOTE: This measurement is limited to phase margins of approximately 71 degrees OR LESS. Above this value, there are no imaginary roots in the output impedance data and, therefore, there will not be a peak in the effective Q waveform. Therefore, in these cases, the software will only say that the margin exceeds 71 degrees. In some cases, you may only be able to measure phase margins of less than 65 degrees depending on the accuracy/noise of the measurement and the group delay waveform conversion.

To measure the stability (phase) margin of your circuit using a T/R measurement (gain/phase ports, E5061B only):

1. Load the Macro, **NISM.VBA** as instructed above. Please refer to the E5061B's user manual for instructions on loading and running the macro.
2. Click the [Macro Run] hardkey. The instrument is now in the macro state.
3. Select ToverR from the mode menu
4. Perform a THRU calibration.

Optional: Load a setup file if available. Several example setup files can be found at <https://www.picotest.com/support.html> in the Setup Files tab.

It is important to make sure that the instrument be in the correct configuration, otherwise, the macro may not be able to process and display the impedance data and computed margins properly.

5. Acquire the magnitude of the output impedance **IN LOG FORMAT** using the T/R ports in trace 1. This data would normally be taken at the output of your regulator, switcher, POL, opamp, filter, etc. Make sure the trace is the LOG MAGNITUDE. You can display the phase of the output impedance in trace two if you want, but the macro you will run in the next step will acquire it if you don't.

You can use any measurement configuration (1 port reflection, 2-port shunt, etc. as long as the measurement is suitable for the impedance level you are measuring). MAKE SURE to keep the measurement acquiring data (probe on the test point or cable connected to the DUT) WHILE you run the macro. That way the macro can acquire the phase data.

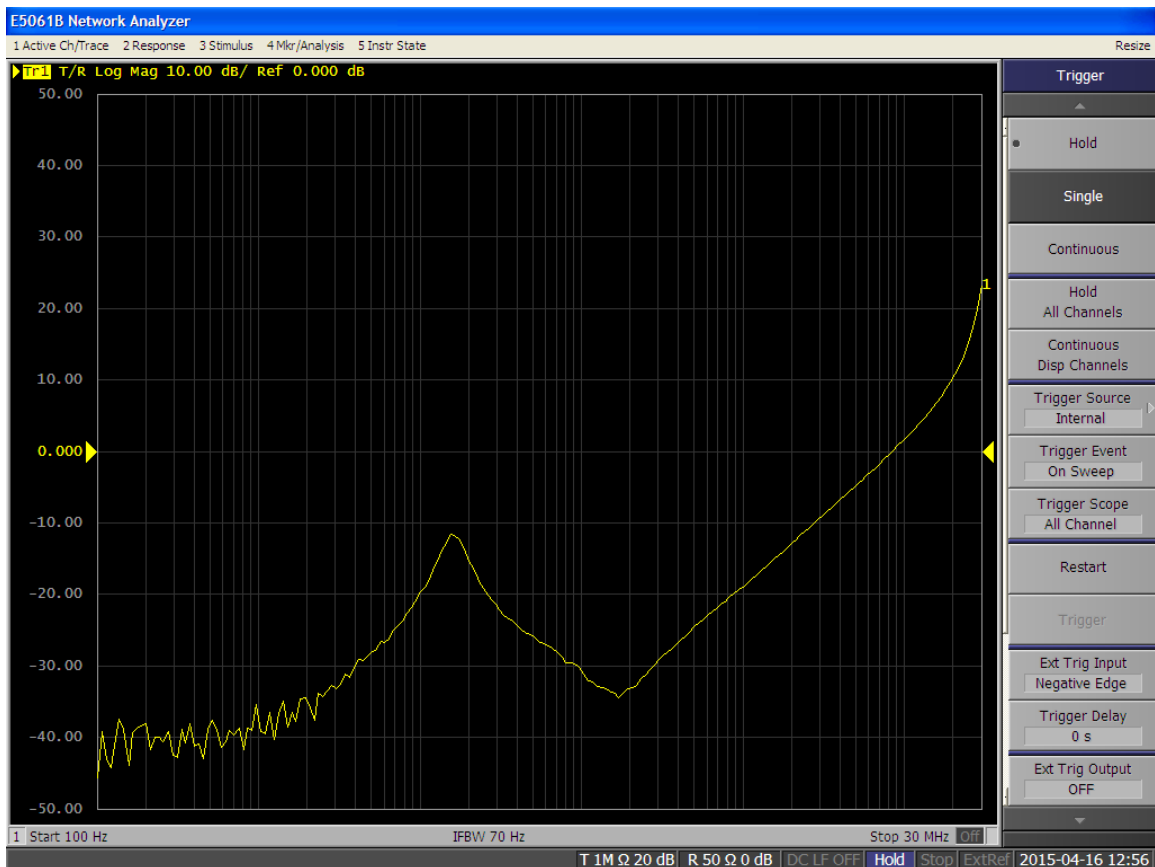

Figure 1: Step 4. Acquire the log magnitude of the output impedance using the T/R ports in trace 1.

- Click Calculate Q in the Command Menu window. The macro will process the impedance data. After the macro runs, a second waveform will be displayed in trace 2; the Effective Q, which is related to the group delay/phase of the output impedance as shown in the next figure.

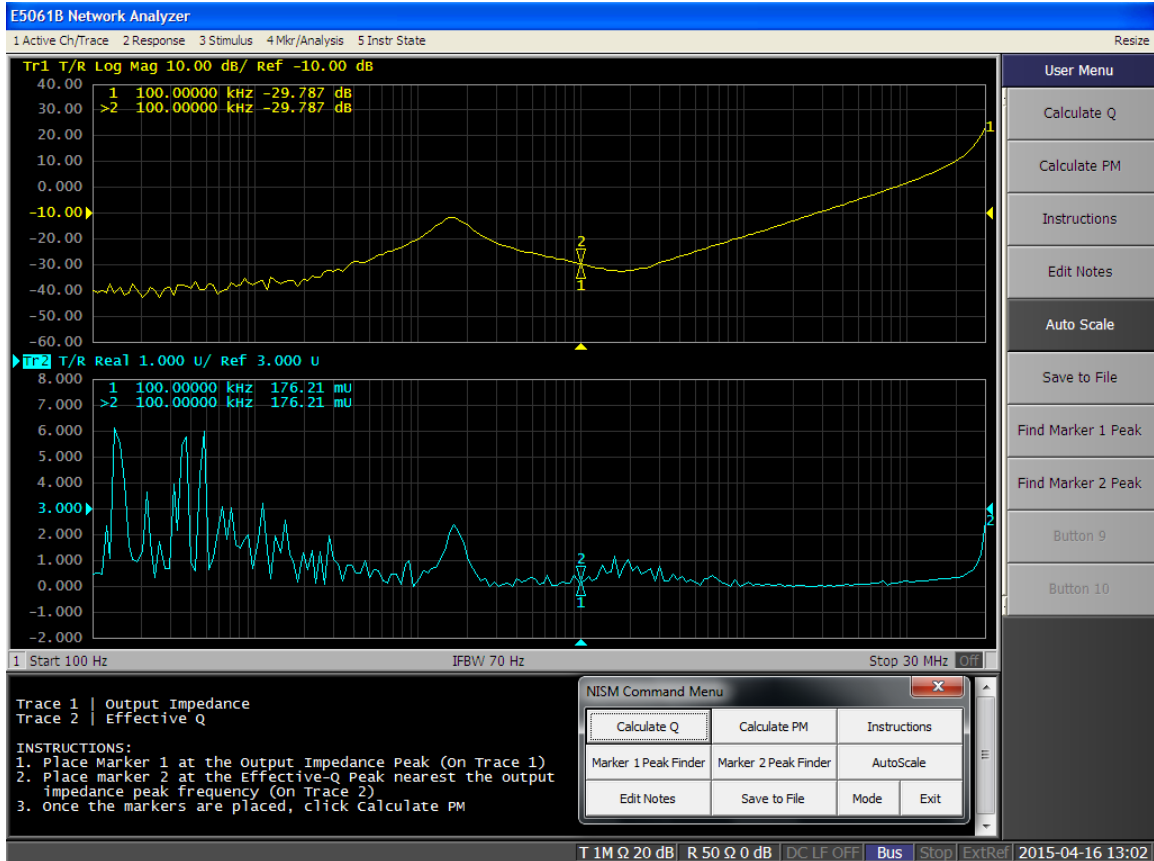

Figure 2: Step 5. After the macro runs, the impedance conversion process will occur and display the Effective Q trace.

- Position marker 1 on trace one (output impedance) at the impedance peak. Position marker 2 on trace two (Effective Q waveform) on the peak nearest in frequency to the impedance peak.

The Marker Peak Finder buttons (Marker 1 Peak Finder/Marker 2 Peak Finder) on the NISM command menu assists in finding a local maximum once you place the marker near the impedance peak. It is useful to first move the marker near the peak.

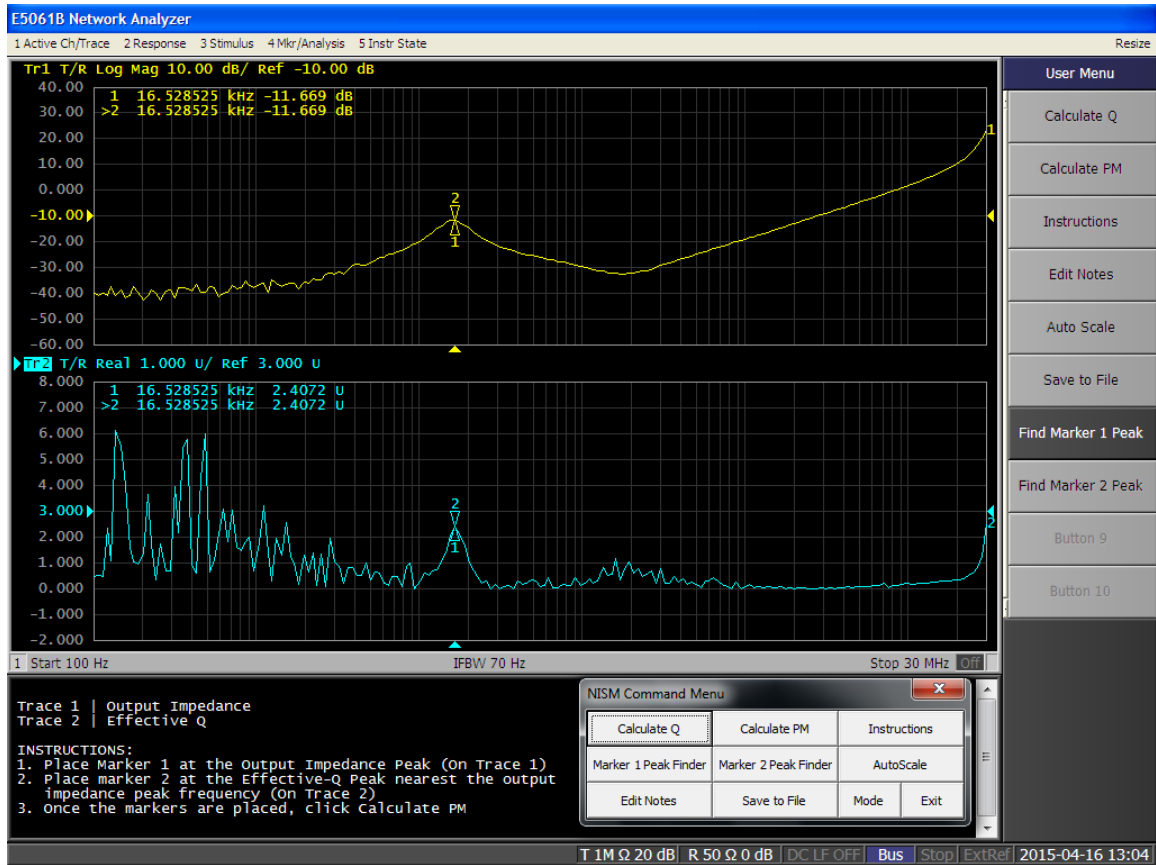

Figure 3: Step 6. Position marker 1 on trace 1 and marker 2 on trace 2 as detailed in the instructions at the bottom of the screen.

8. Click the “Calculate PM” button in the User menu. The phase margin will be displayed at the bottom of the instruction window. You may move the markers and click the Calculate button repeatedly to update the Phase Margin computation.

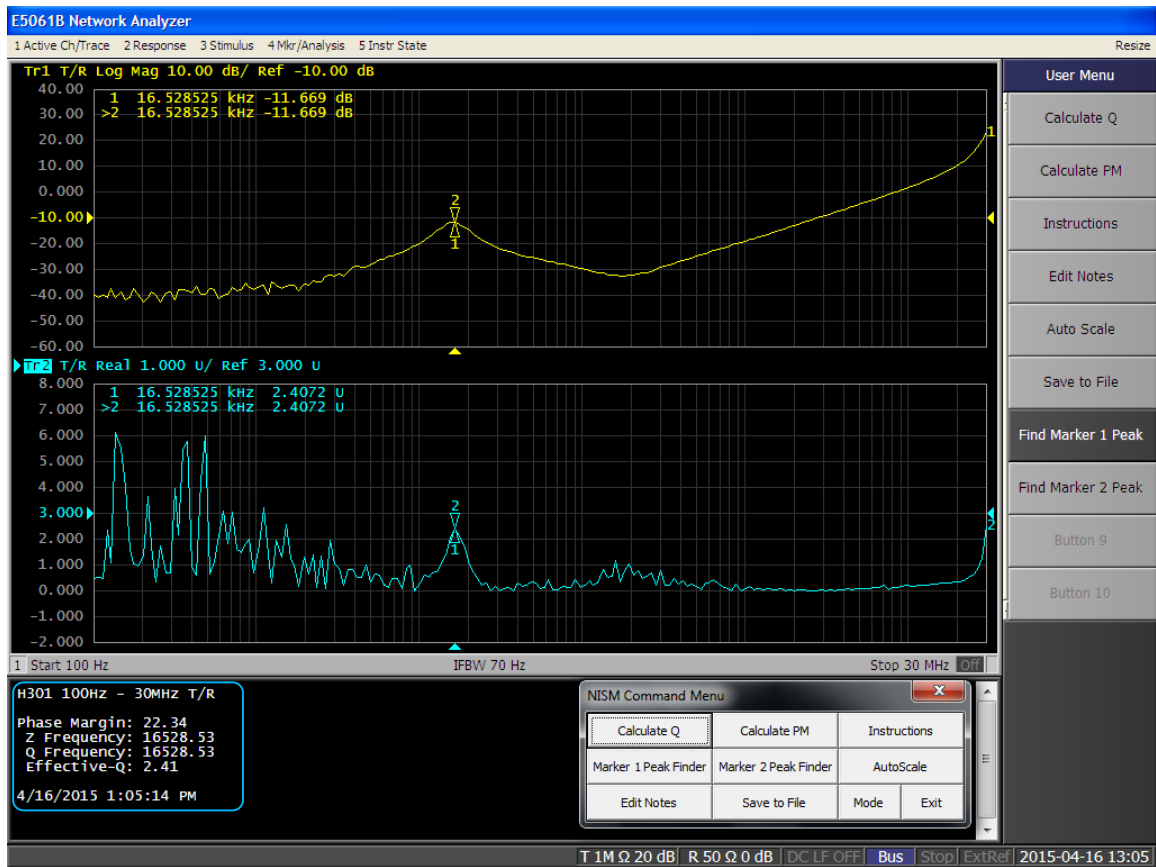

Figure 4: Step 7. After positioning the markers, click the “Calculate PM” button. The phase margin will be displayed at the bottom of the instruction window.

Note: if you change or re-measure the output impedance, you will need to click the ‘Calculate Q’ button to re-measure the impedance and re-compute the Effective Q waveform.

To Measure Stability (Phase) Margin of your circuit using Port 1/Port 2 High Frequency Ports (for 1-port or 2-port) measurements:

1. Load the Macro. For the E5061B, use **NISM.VBA**. For the E5071C, use **E5071C NISM.VBA**.
2. Click the [Macro Run] hardkey.
3. Perform an OPEN/SHORT/THRU calibration.
4. Select Port 1 - Port 2 from the mode menu
5. Adjust the scopes settings as required for your particular measurement.
6. Acquire the output impedance in LOG MAGNITUDE format (S11) in trace 1. Next, open another trace and set trace 2 to also be in LOG MAGNITUDE format (S11). For a more detailed example of how to appropriately setup the instrument for a NISM 1Port-2Port measurement, see Example 2 in Chapter 3 below.

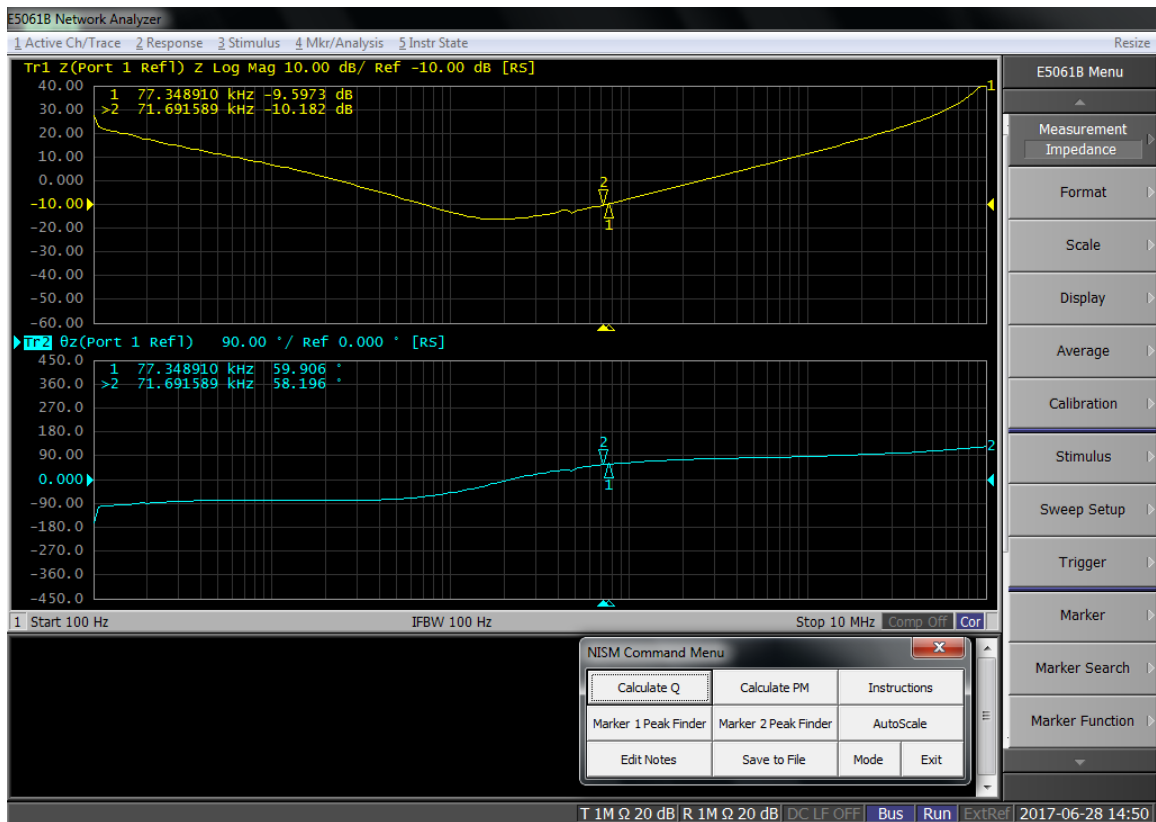

Figure 5: Step 4. Make sure that trace 1 is in log magnitude S11 Format.

- Click Calculate Q in the Command Menu. After the macro runs, phase of the output impedance waveform will be replaced by a new waveform; the Effective Q, which is related to the Group Delay of the output impedance. As the macro runs, make sure your test probe is on the test point and the output impedance data that is being collected is valid.

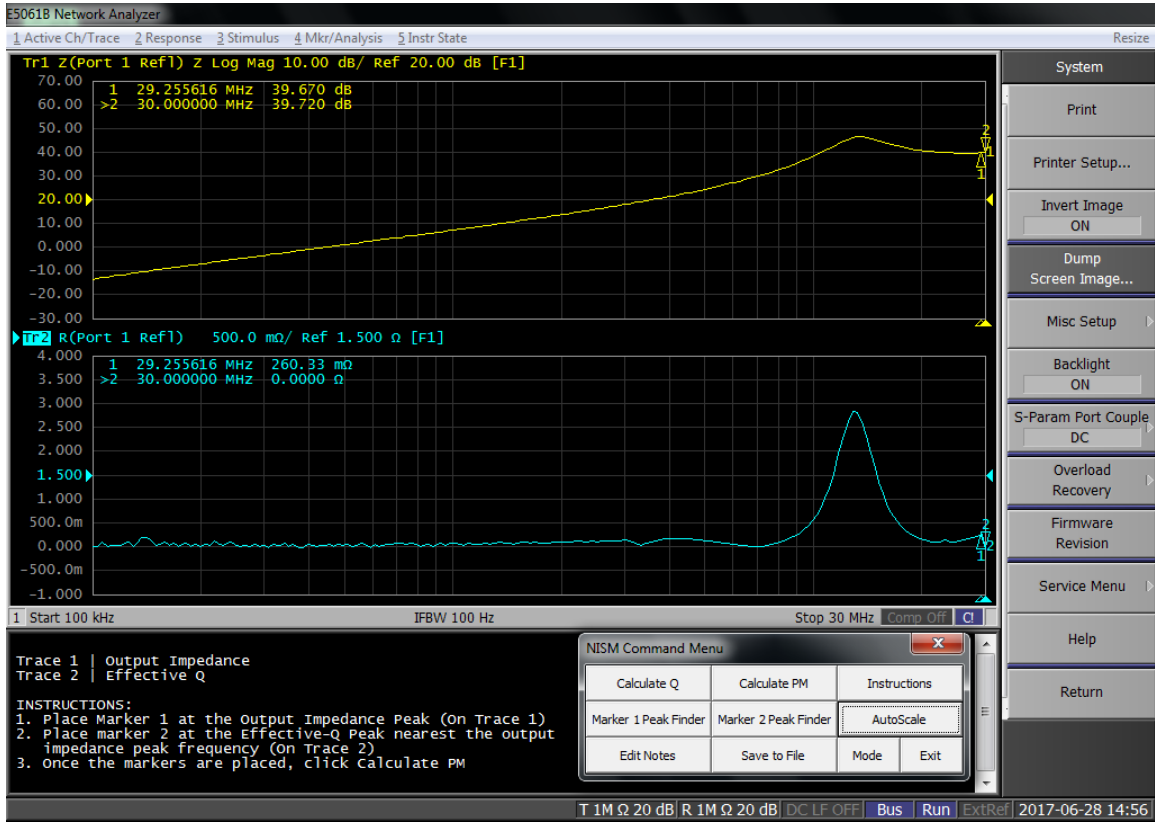

Figure 6: Step 5. After the macro runs, the impedance conversion process will begin and the phase trace will be replaced with the Effective Q waveform.

8. Position marker 1 on trace 1 (output impedance magnitude) at the impedance peak. Position marker 2 on trace two (Effective Q) on the peak nearest in frequency to the impedance peak. The Marker Peak Finder buttons on the NISM command menu assist in finding the local maxima once you place the marker near the impedance peak.

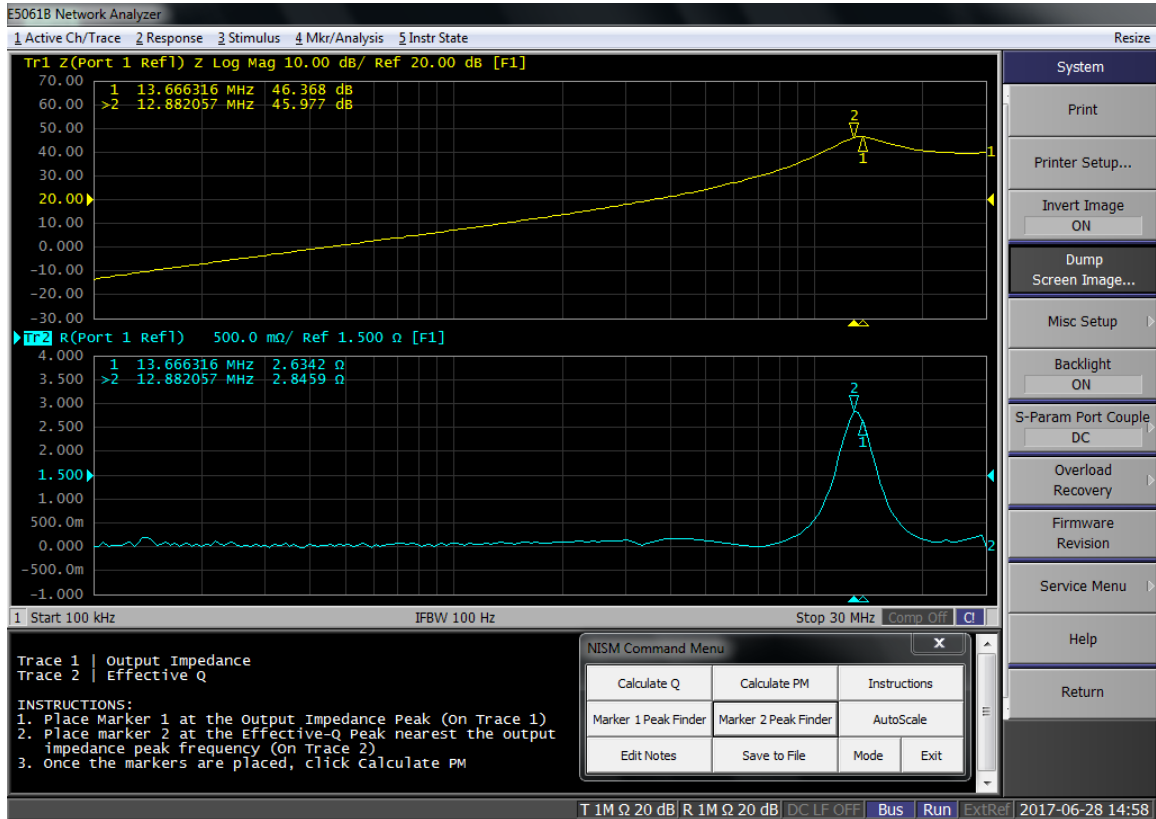

Figure 7: Step 6. Position marker one on trace 1 and marker 2 on trace 2 as detailed in the instructions at the bottom of the screen.

- Click the “Calculate PM” button. The phase margin will be displayed at the bottom of the instruction window. You may move the markers and click the Calculate PM button repeatedly in order to update the Phase Margin computation.

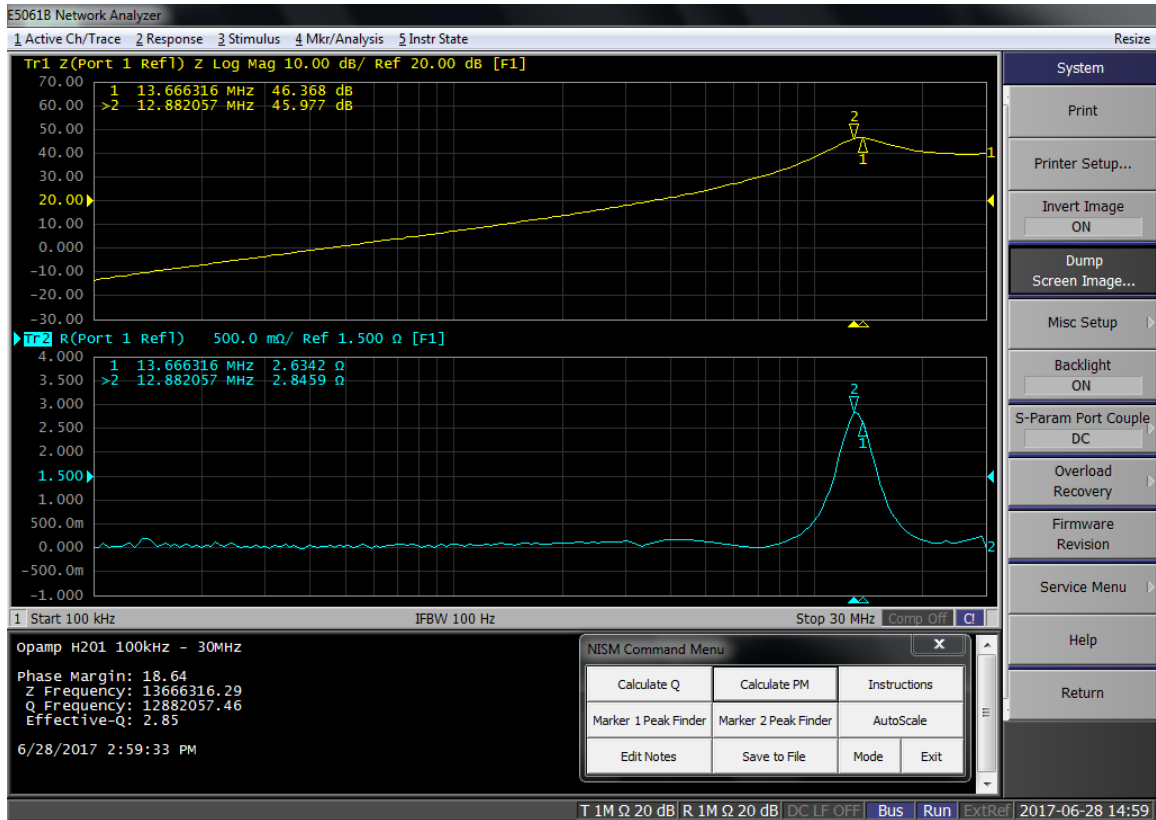

Figure 8: Step 7. After positioning the markers, click the “Calculate PM” button. The phase margin will be displayed at the bottom of the instruction window.

Note: if you change or re-measure the output impedance, you will need to click the Calculate Q button to gather the waveform data and re-compute the Effective Q waveform.

Saving Data

Once you have calculated and displayed the phase margin, you can save the information by clicking the **Save to File** button on the Command Menu. Save to File will prompt you to enter measurement notes if you have not already, then it will save all the files to the location of your choosing with the measurement notes as the prefix for the file name.

Annotating Your Measurement

You can save a note detailing your measurement along with the data.

To set a note for the measurement:

1. Click the Edit Note button on the Command Menu.
2. Enter your notes and click OK.

To set the location where data will be saved:

1. Click Save to File. A file browser will pop (if it doesn't, it may be hidden behind the network analyzer window).
2. Navigate to the desired location and click OK.

Note: The Save dialog may be hidden behind the Network Analyzer's main window. You will have to move the Save dialog to the foreground.

Several files will be saved to disk. They will have a filename made up of your Measurement Note plus the name of the waveform. The data is saved in CSV file format; the images are saved in PNG format.

Installing and Running the Software – Rohde & Schwarz

For the Rohde & Schwarz ZNL/ZNLE

To install and run the NISM software:

1. Copy the "Picotest Non-Invasive Stability Measurement for R&S ZNL(E) xxx.msi" file to the instrument
2. Run the Picotest Non-Invasive Stability Measurement for R&S ZNL(E) xxx.msi installer.

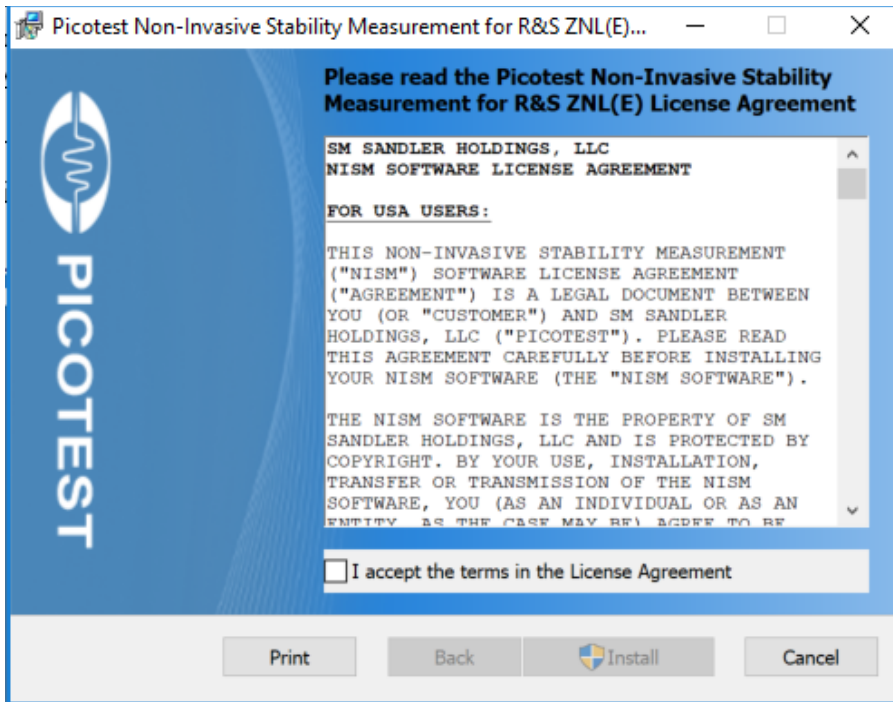

3. When installation is complete, select Finish.

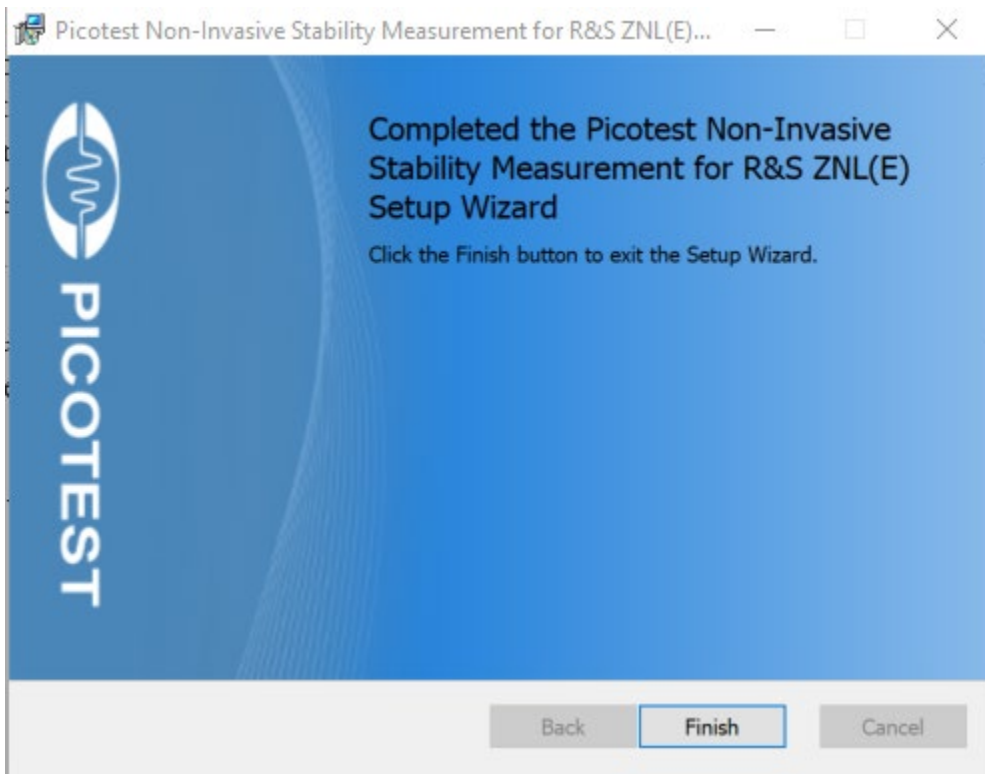

4. To run the software, select Non-Invasive Stability Measurement.

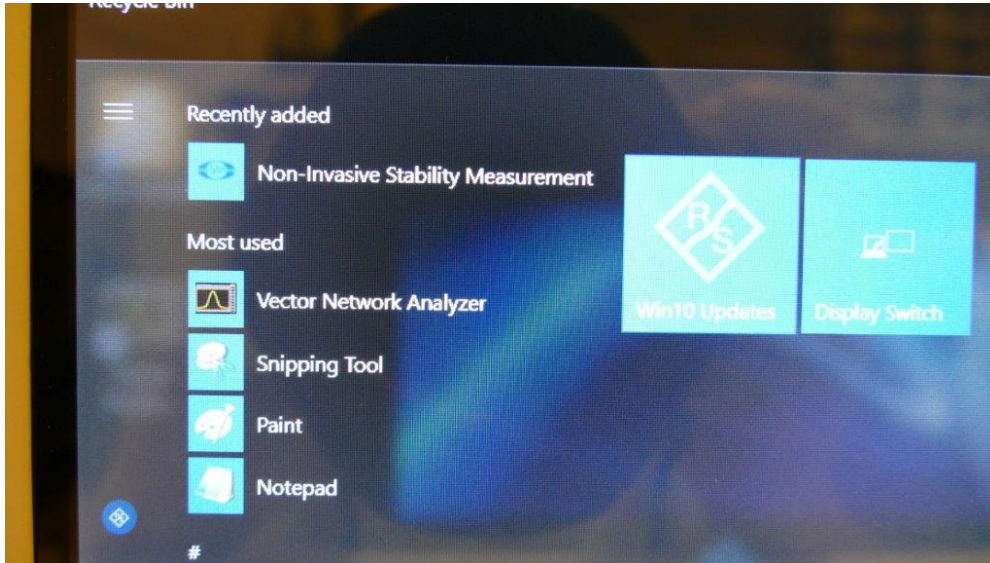

Making Non-Invasive Stability Measurements - Rohde & Schwarz

Instructions on running the software are shown below.

PLEASE NOTE: This measurement is limited to phase margins of approximately 71 degrees OR LESS. Above this value, there are no imaginary roots in the output impedance data and, therefore, there will not be a peak in the effective Q waveform. Therefore, in these cases, the software will only say that the margin exceeds 71 degrees. In some cases, you may only be able to measure phase margins of less than 65 degrees depending on the accuracy/noise of the measurement and the group delay waveform conversion.

To measure the stability (phase) margin of your circuit using an impedance measurement:

1. Run the Non-Invasive Stability Measurement program.



Figure 9: Initialized state of the instrument after running the NISM software. Not the NISM dialog to the right.

There are three functions/buttons in the NISM dialog:

Data -> Mem – Saves Trace 1

Calculate Q – Computes the $Q(Tg)$ response based on the Group Delay function. It is the Q of the impedance waveform

Calc Phase Margin – Takes data from the Trace 1 impedance waveform and Trace 2 $Q(Tg)$ waveform and displays the phase margin)

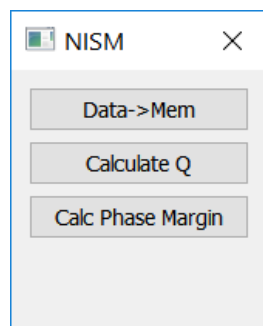

2. Measure the impedance of the control loop (or other loop) whose phase margin you would like to test.

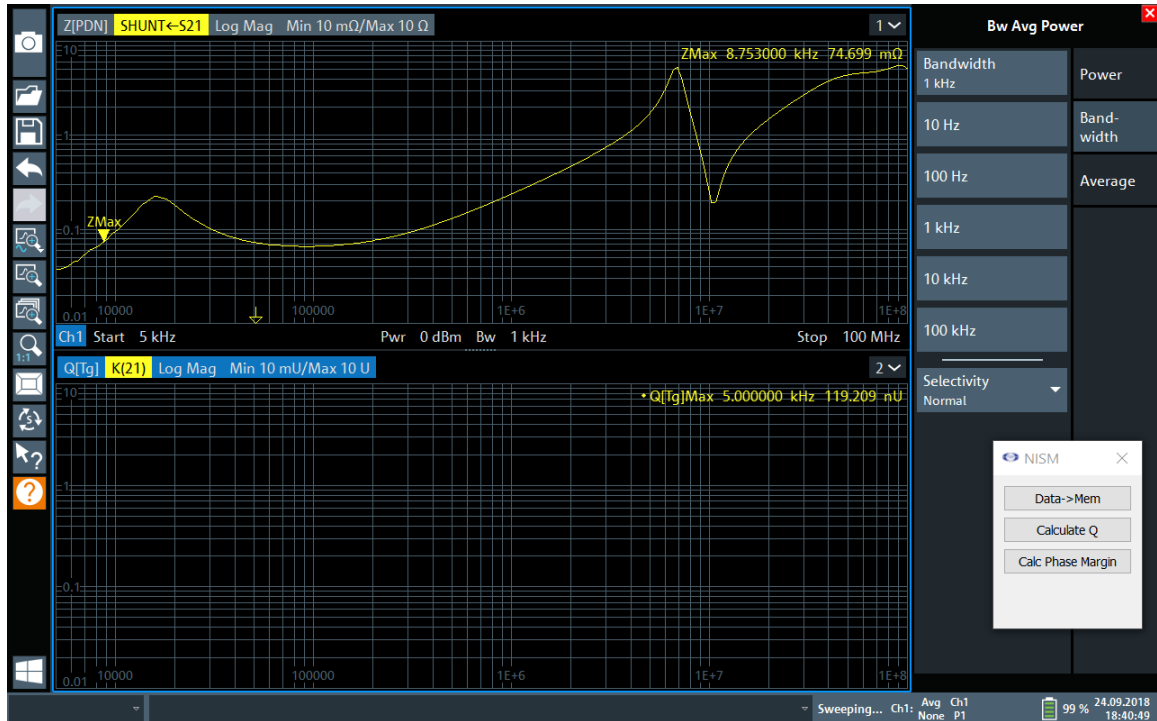

Figure 10: Impedance is measured as trace 1. Click Calculate Q.

3. Click the Calculate Q button.

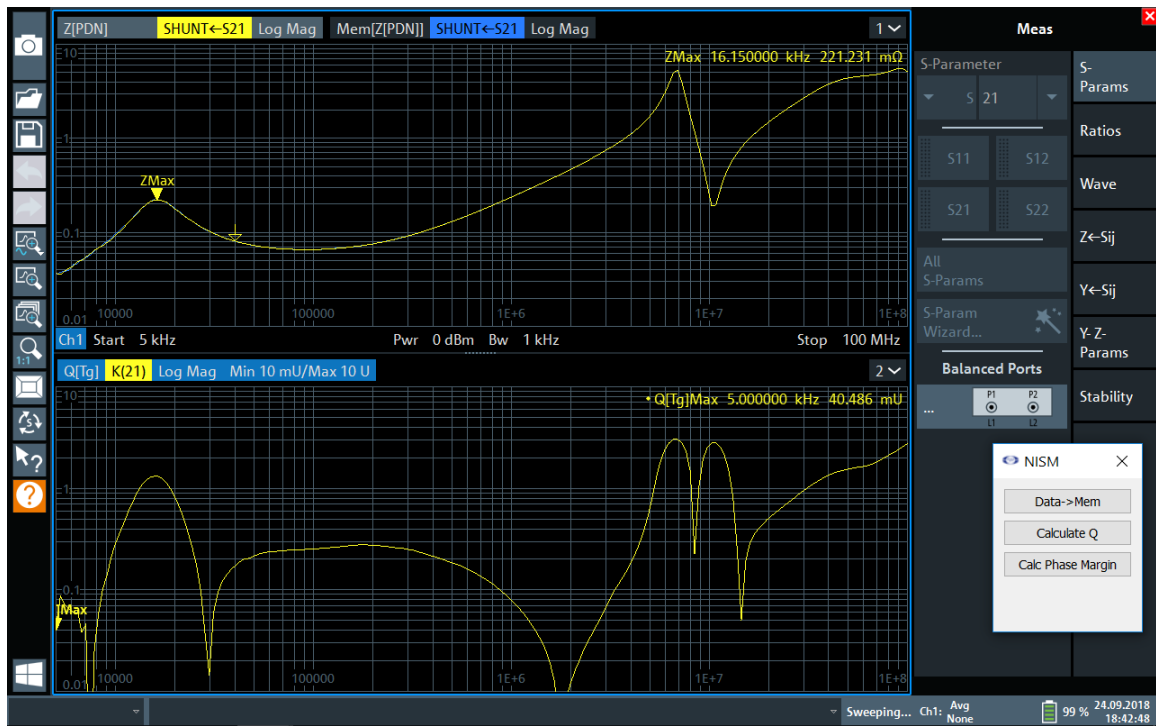

Figure 11: The $Q(T_g)$ waveform is created in trace 2 from the impedance waveform in trace 1.

4. Position the cursor on Trace 1 at the impedance peak. Position the cursor on Trace 2 at the $Q(Tg)$ peak nearest the impedance peak.

This is normally the bandwidth of the control loop or power circuit you are trying to measure. Other (higher frequency) resonances may be passive or active.

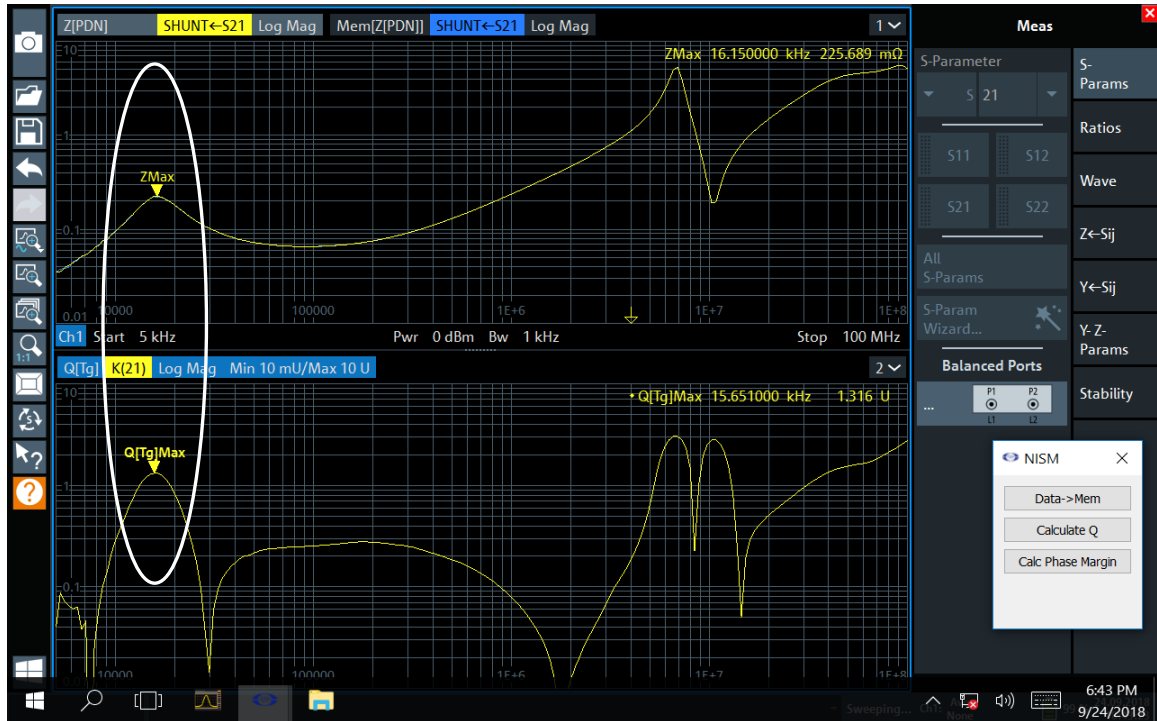

Figure 12: Place the cursors at the waveform peaks.

- Click the Calc Phase Margin button.

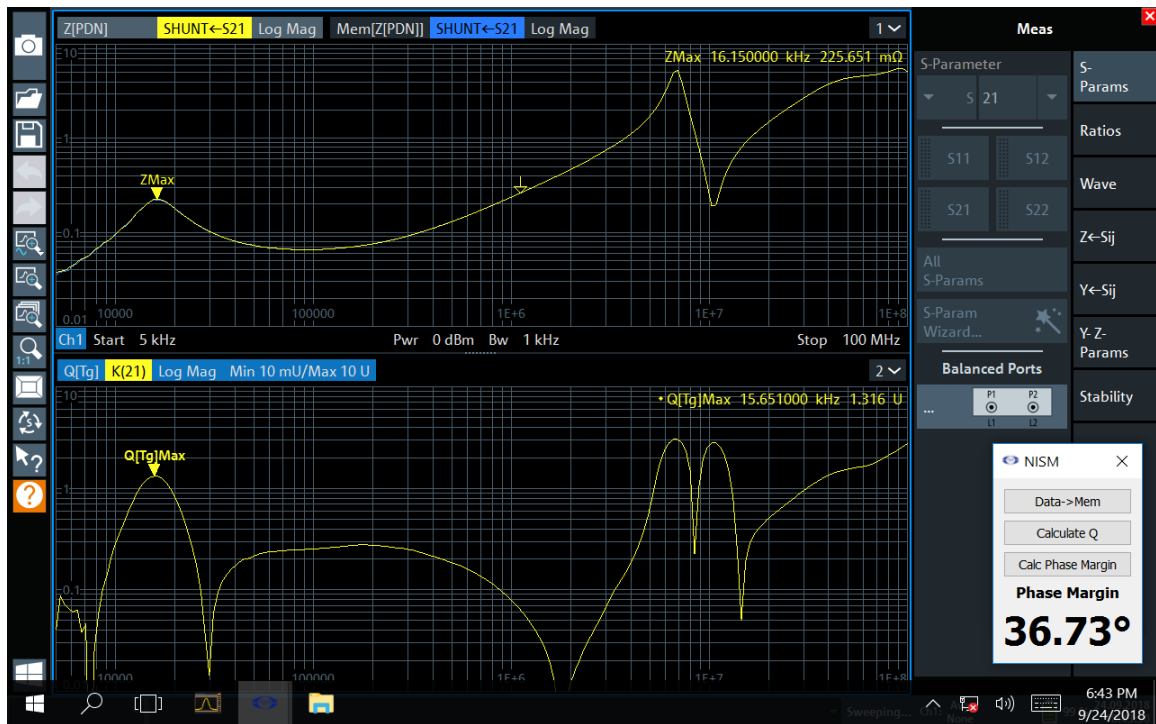

Figure 13: After clicking the Calc Phase Margin button the Phase Margin is displayed in the dialog.

You can measure the loop in the off state to see if the resonance is impacted by power-on state. This is a useful pairing of impedance measurements since it will tell you whether the resonance is passive or part of the active control loop. You can then choose to change the circuit design accordingly to address either resonance.

In the figure below, since the high frequency resonances are always present, they are passive and not part of the active control loop resonance at lower frequency.

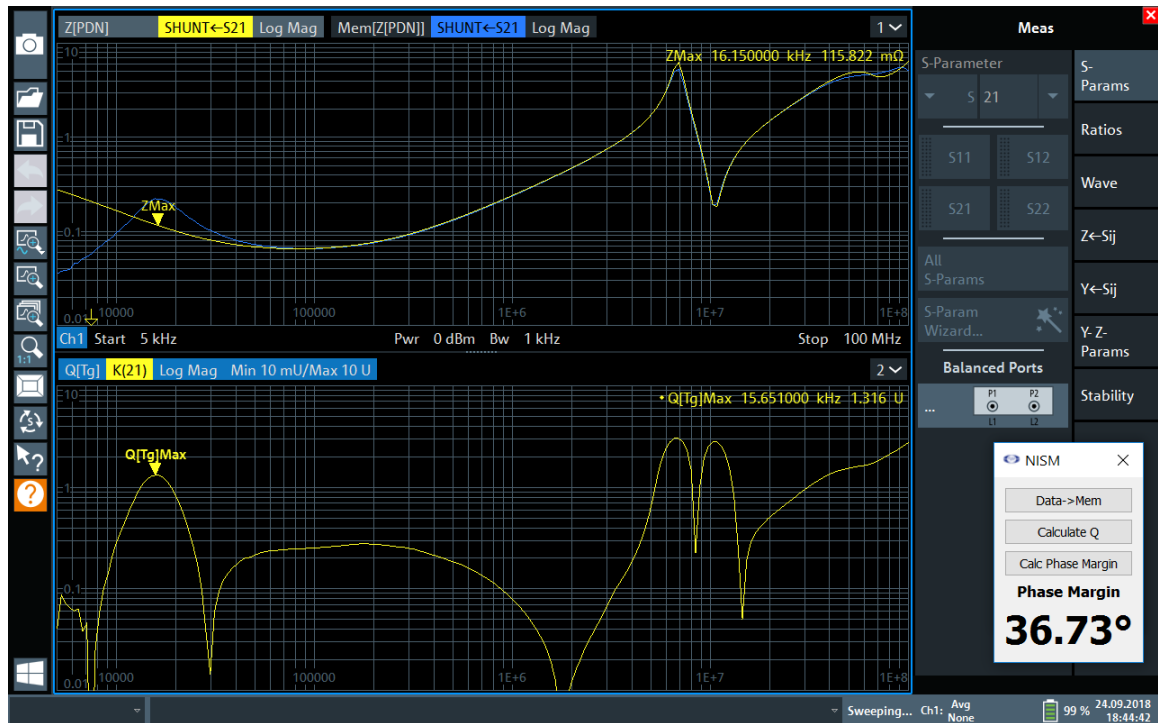

Figure 14: The powered on state (blue) is shown against the power-off state (yellow, impedance measured in the off-state). The powered-on trace was saved to memory using the Data -> Mem button in order to do the comparison.

Chapter 3 - Examples

This chapter provides several example Non-invasive stability measurements using the Picotest VRTS3 demonstration board.

Example 1– T Over R Measurement

In this example for the E5061B, we will assess the stability of a low-drop out linear regulator using only the LDO's output impedance. Referring to the VRTS3 manual (<https://www.picotest.com/downloads/VRTS03/VRTS3-User-Guide.pdf>) we will measure test point H301 on the Picotest VSRT3 Demo board. The test setup can be found in this document, [https://www.picotest.com/articles/Agilent-App-Notes/Non-Invasive Assessment of Voltage Regulator Phase Margin.pdf](https://www.picotest.com/articles/Agilent-App-Notes/Non-Invasive-Assessment-of-Voltage-Regulator-Phase-Margin.pdf). A setup diagram is shown below.

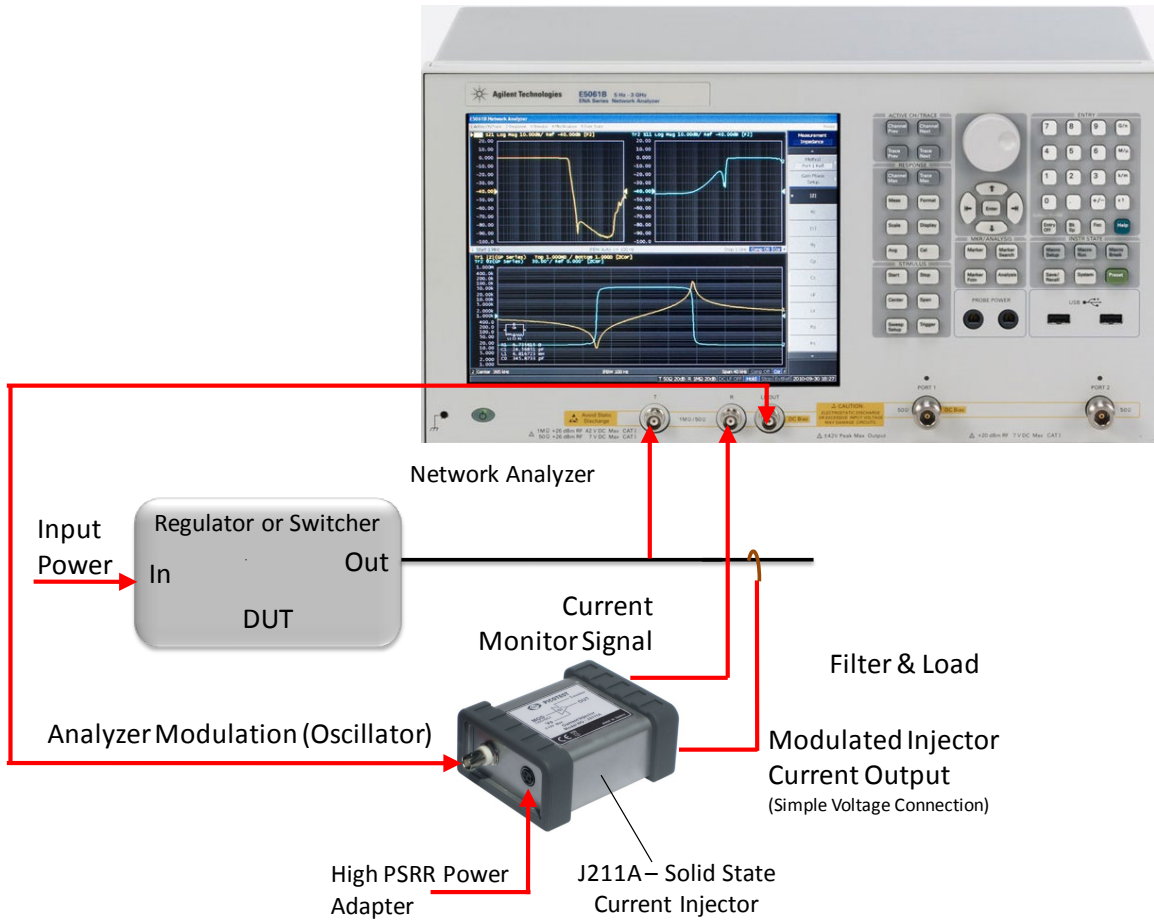
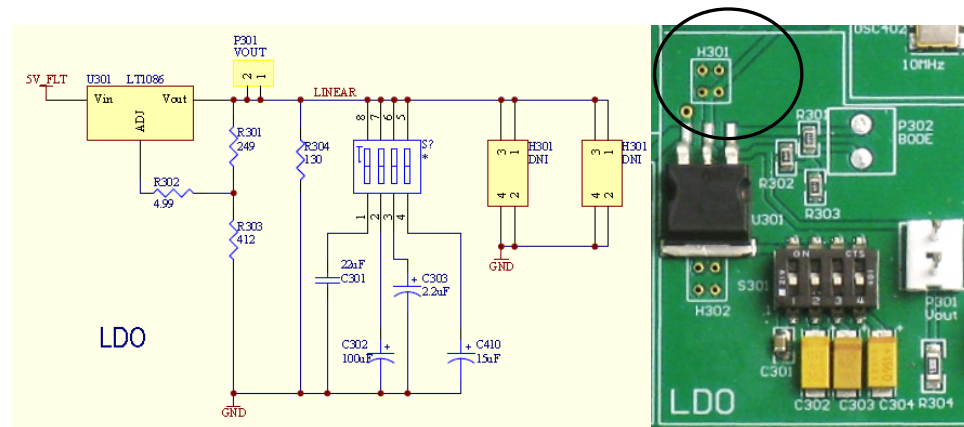

Figure 15: The impedance test setup. Connections to the injector can be made with BNC cables. The connections from the E5061B to the VRTS3 board can be made with simple voltage probes.

The test setup to measure impedance of regulators uses the J2111A Current Injector, https://www.picotest.com/products_J2111A.html. An Injector user manual can be found here, <https://www.picotest.com/downloads/INJECTORS/Injector-Manual-1.3.pdf>.

We are going to use the T/R (GP) ports to measure the LDO impedance. The circuit and board image are shown below. Once you have your hardware set up correctly, you can begin adjusting the instruments measurement settings. Follow the step-by-step instructions below.



VRTS3 LDO circuit and H301 test point.

Instrument Setup: from the instrument's main menu,

1. Click Measurement S11
 - a. Click Measurement Port [S-Parameter]
 - i. Click Gain-Phase
 - ii. Click Return
 - b. Click Gain-Phase Setup
 - i. Click R Input Z
 1. Click 50Ohms
 - ii. Click R Attenuator
 1. Click 0 dB
 - c. Click Return
2. Click Average
 - a. Click IF Bandwidth
 - i. Change IF Bandwidth to 70Hz
 - ii. Click Return
3. Click Stimulus
 - a. Click Start
 - i. Change Start to 100Hz
 - ii. Click Return
4. Click Sweep Setup
 - a. Click Sweep Type
 - i. Click Log Freq

The instrument should now be set up correctly.

Next, we'll measure stability (Phase) margin of the circuit.

1. Load and run the macro, **NISM.VBA**.
2. Probe the board at H301 and measure the impedance magnitude in trace 1.
3. Click the [Macro Run] hardkey.
4. Make sure to keep the measurement active (probed) while you run the macro. That way the macro can acquire the phase data.

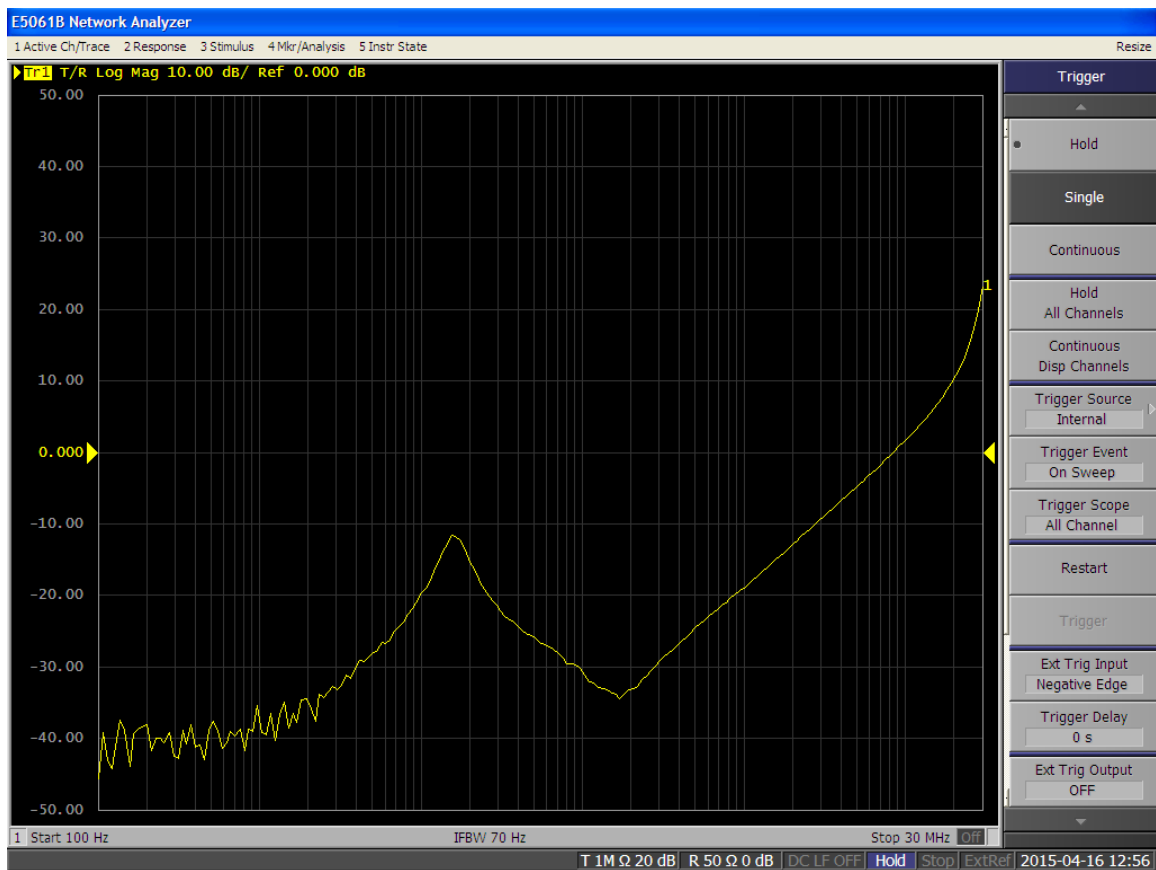

Figure 16: Step 4. Acquire the magnitude of the output impedance using the T/R ports in trace 1.

- Click the Calculate Q button in the Command Menu. The macro will process the impedance data. After the macro runs, a second waveform will be displayed in trace 2; the Effective Q, which is related to the Group Delay of the output impedance, as shown below.

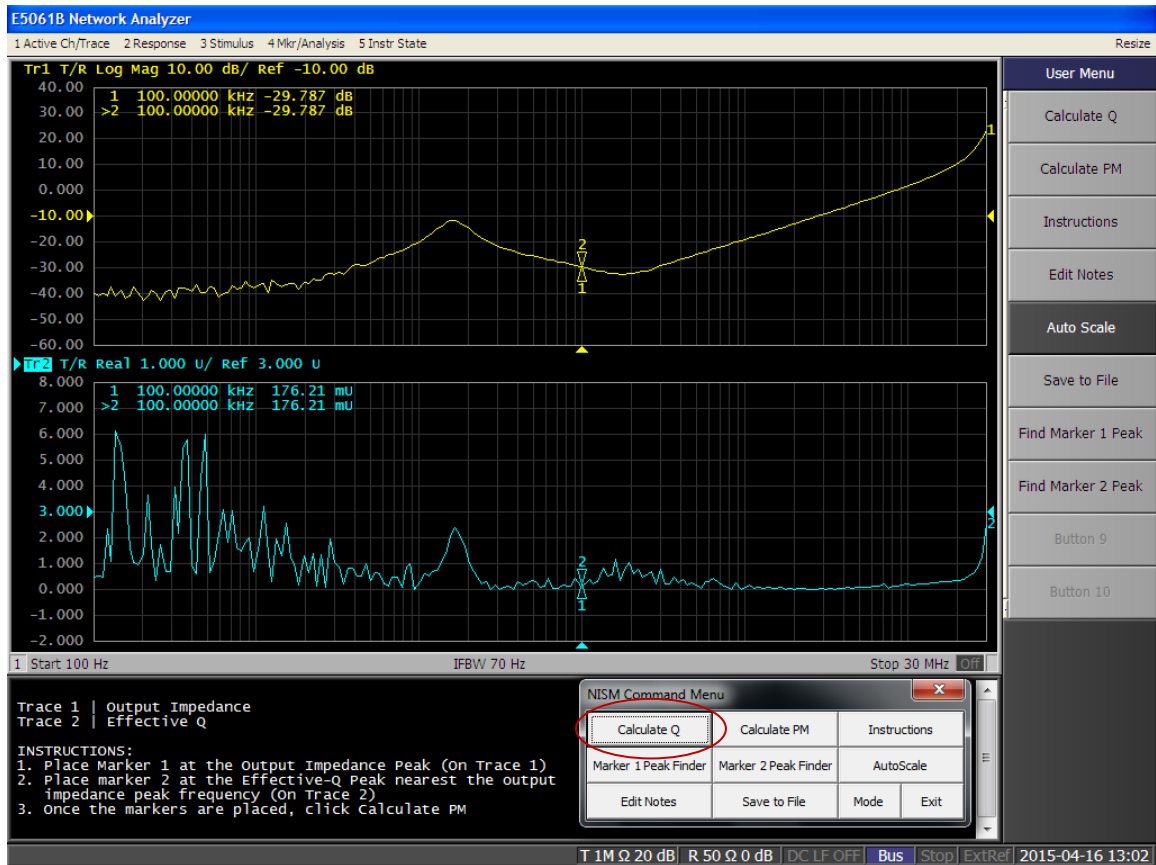

Figure 17: Step 5. After the macro runs (Calculate Q button), the impedance conversion process will occur and display the Effective Q trace.

6. Position marker 1 on trace one (output impedance) near the impedance peak. Position marker 2 on trace two (Effective Q waveform) on the peak nearest in frequency to the impedance peak frequency. The Marker Peak Finder buttons on the NISM command menu assist in finding a local maximum once you place the marker near the impedance peak.

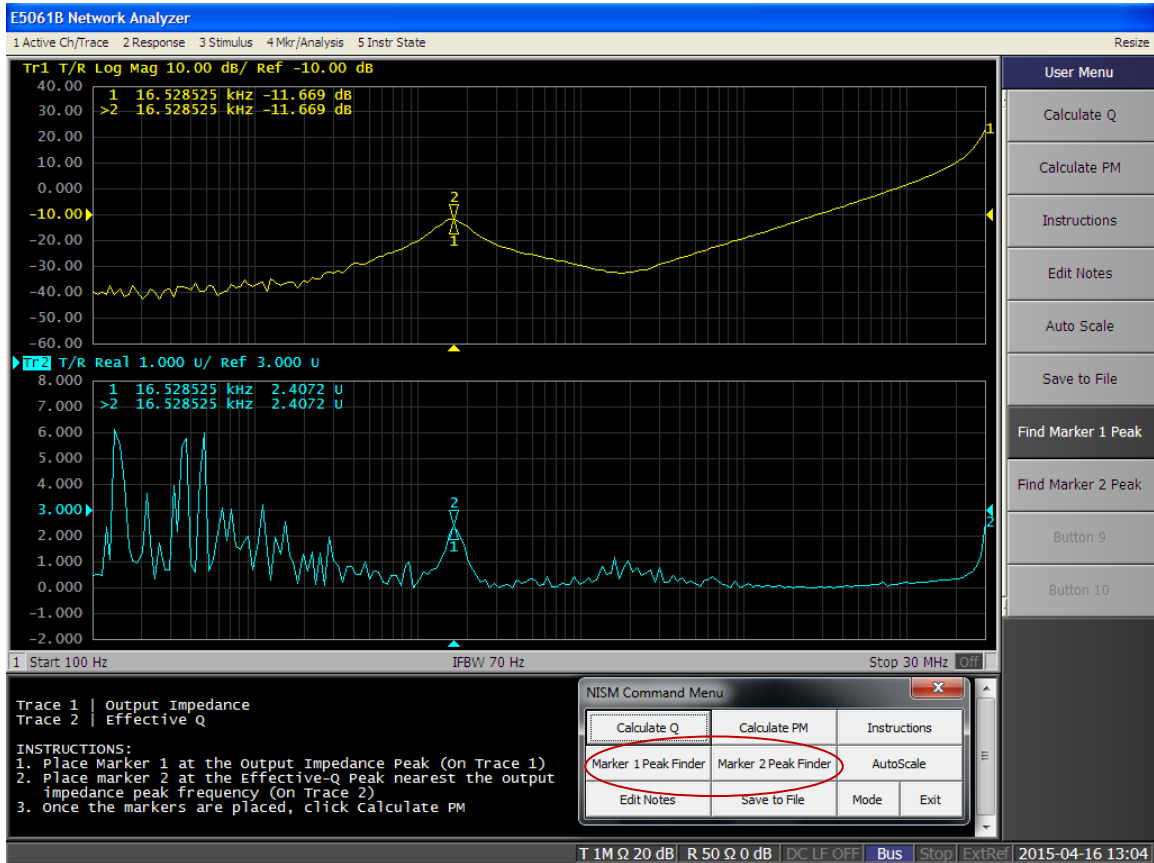

Figure 18: Step 6. Position marker 1 on trace 1 and marker 2 on trace 2 as detailed in the instructions at the bottom of the screen.

- Click the “Calculate PM” button in the User menu. The phase margin will be displayed at the bottom of the instruction window. You may move the markers and click the Calculate PM button repeatedly to update the Phase Margin computation.

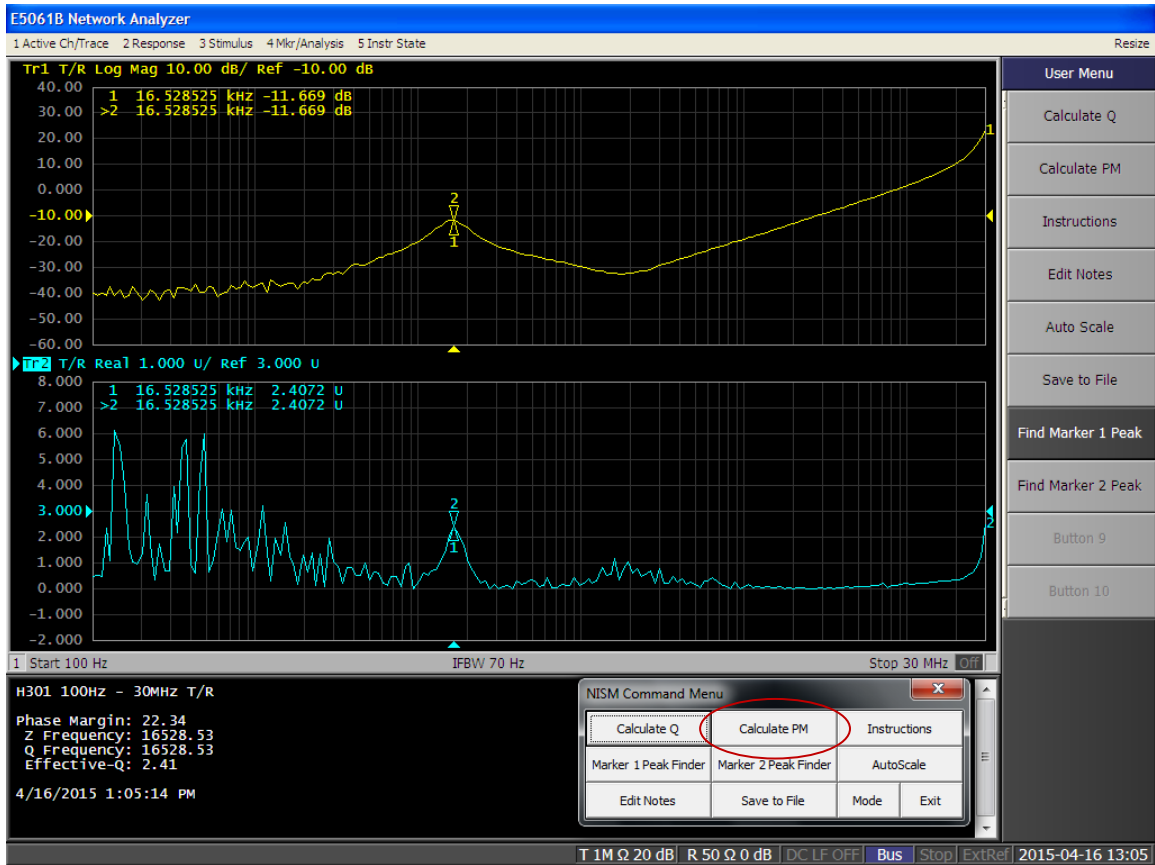

Figure 19: Step 7. After positioning the markers, click the “Calculate PM” button. The phase margin will be displayed at the bottom of the instruction window.

Note: if you change instrument settings or re-measure the output impedance, you will need to click the Calculate Q button to re-compute the Effective Q waveform.

See the section on Saving Data or the native E5061B print data file dialogs to save your measurement results.

This concludes Example 1.

Example 2 – 1Port – 2Port Measurement

In this example, we will use the high frequency Ports 1 & 2 to measure the stability of an opamp via its output impedance. To do this we will probe the H201 test point on the Picotest VSRT3 Demo board and use the NISM.VBA macro.

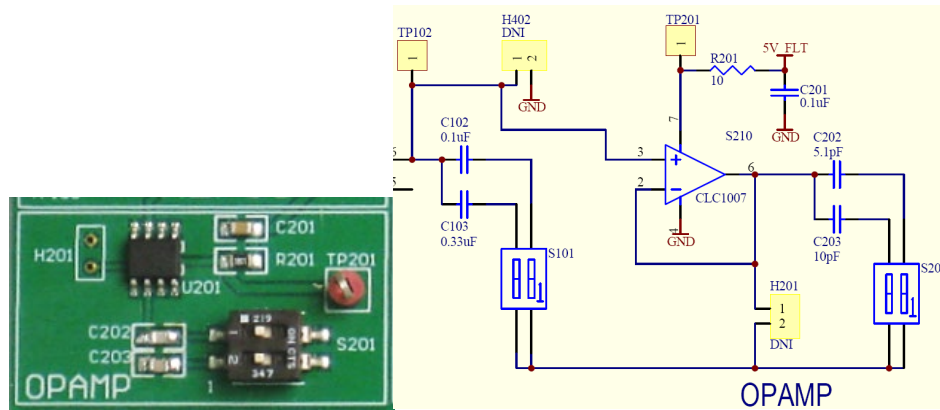

Figure 20: Opamp circuit and H201 test point. The H201 test point can be measured using the Picotest 1 Port PDN probe. The picture above shows the reference being tested. The H201 test point is just below the reference.

For more information about the test board required for this example measurement, please see [https://www .picotest.com/products_VRTS03.html](https://www.picotest.com/products_VRTS03.html). The output impedance of the opamp can be measured by connecting the Picotest 1-Port PDN probe to Port 1 on the E5061B.

Once you have your hardware set up correctly, begin adjusting the instruments measurement settings. Follow the step-by-step instructions below:

From the instrument's main menu,

1. Click measurement S11
 - a. + Click impedance analysis menu
 - i. Click $|z|$
 - ii. Click Return
 - b. Click Display
 - i. Click Num of Traces
 1. Click 2
 2. Click Return
2. Click on Trace two
 - a. Click measurement S11
 - i. Click impedance analysis menu
 1. Click $|z|$
 2. Click Return
3. Click Average
 - a. Click IF Bandwidth
 - i. Change bandwidth to 100Hz
 - ii. Click Return
4. Click Stimulus
 - a. Click Start
 - i. Change Start to 100k
 - b. Click Stop
 - i. Change Stop to 50M
 - c. Click Return
5. Click Sweep Setup
 - a. Click Power
 - i. Change Power to -20dB
 - ii. Click Return
 - b. Click Sweep Type

- i. Click Log Freq
 - c. Click Return
 6. Click Calibration
 - a. Click Calibrate
 - i. Click 1Port Cal
 1. Click Open (on the VRTS3)
 2. Click Short (on the VRTS3)
 3. Click Load (on the VRTS3)
 4. Click Done
 5. Click Return
 - ii. Click Return
 - b. Click Return

The instrument should now be set up correctly,

Next, you can convert the impedance to Stability (Phase) Margin using NISM.

1. Load the Macro, **NISM.VBA**.
2. Click the [Macro Run] hardkey.
3. Select Port 1 from the mode menu.
4. Probe the test point and acquire the output impedance MAGNITUDE data (S11) in trace 1.

This data would normally be taken at the output of your regulator, switcher, POL, opamp, filter, etc. You can use any measurement configuration (1 port reflection, 2-port shunt, etc. to gather the data if the measurement is suitable for the impedance level you are measuring).

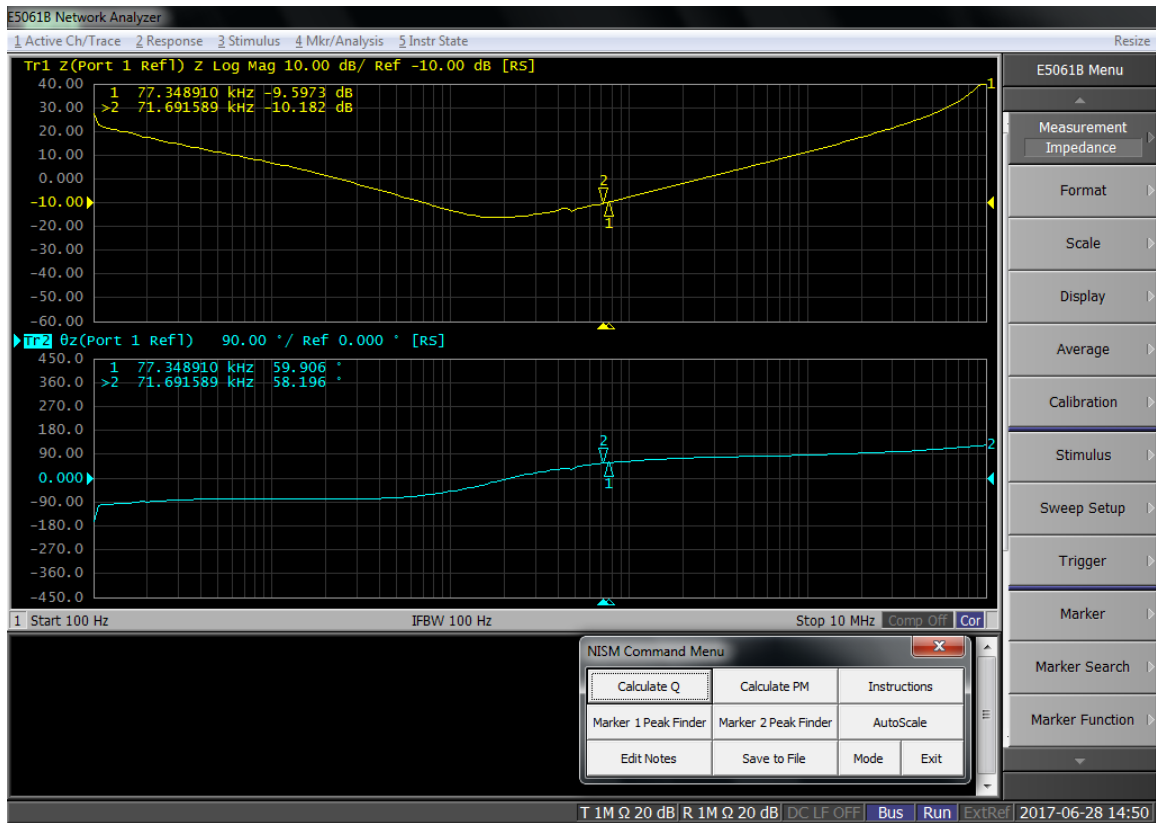

Figure 21: Step 4. Acquire the magnitude of the output impedance in trace 1.

- Click Calculate Q. After the macro runs, the output impedance phase waveform will be replaced by a new waveform; the Effective Q, which is related to the Group Delay of the output impedance. As the macro runs, make sure your test probe is on the test point and the output impedance data that is being collected is valid.

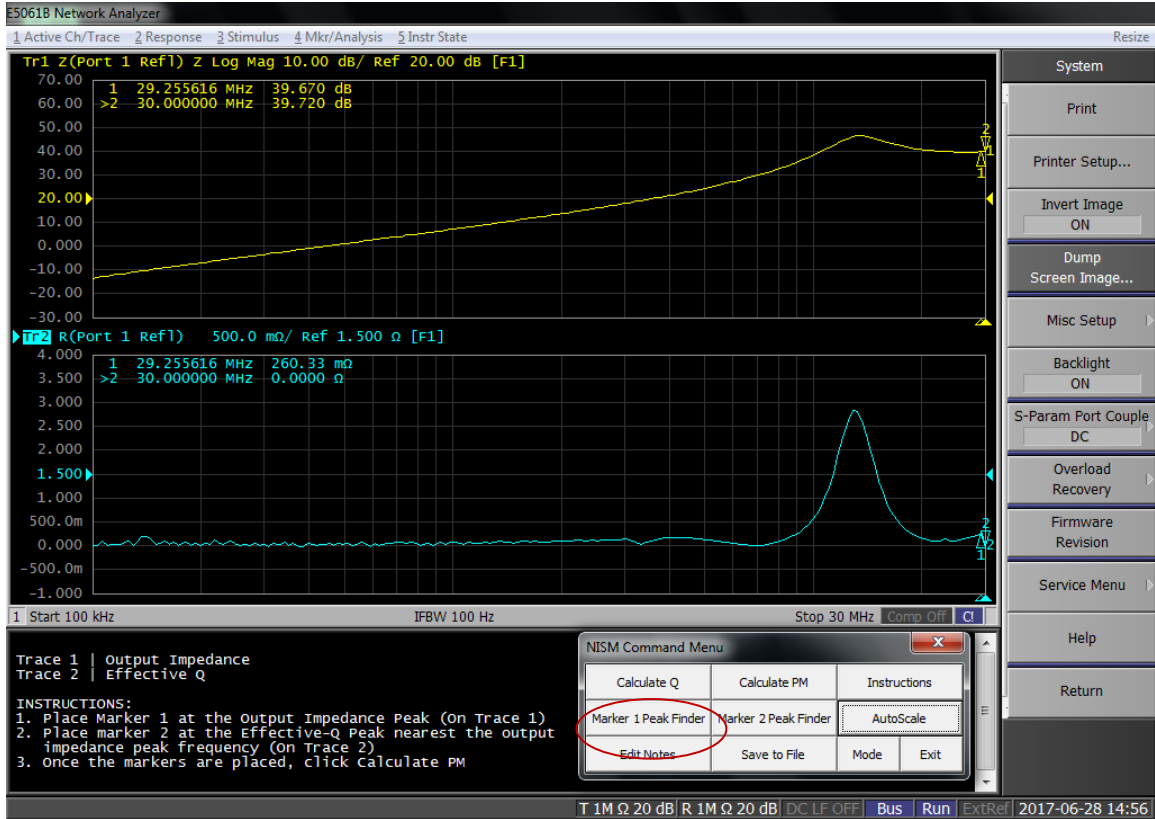

Figure 22: Step 5. After the macro runs, the impedance conversion process will begin and the Effective Q waveform will appear in trace 2.

- Position marker 1 on trace 1 (output impedance magnitude) at the impedance peak. Position marker 2 on trace two (Effective Q) on the peak nearest in frequency to the impedance peak. The Marker Peak Finder buttons on the NISM command menu will assist in finding a local maximum one you place the marker near the impedance peak.

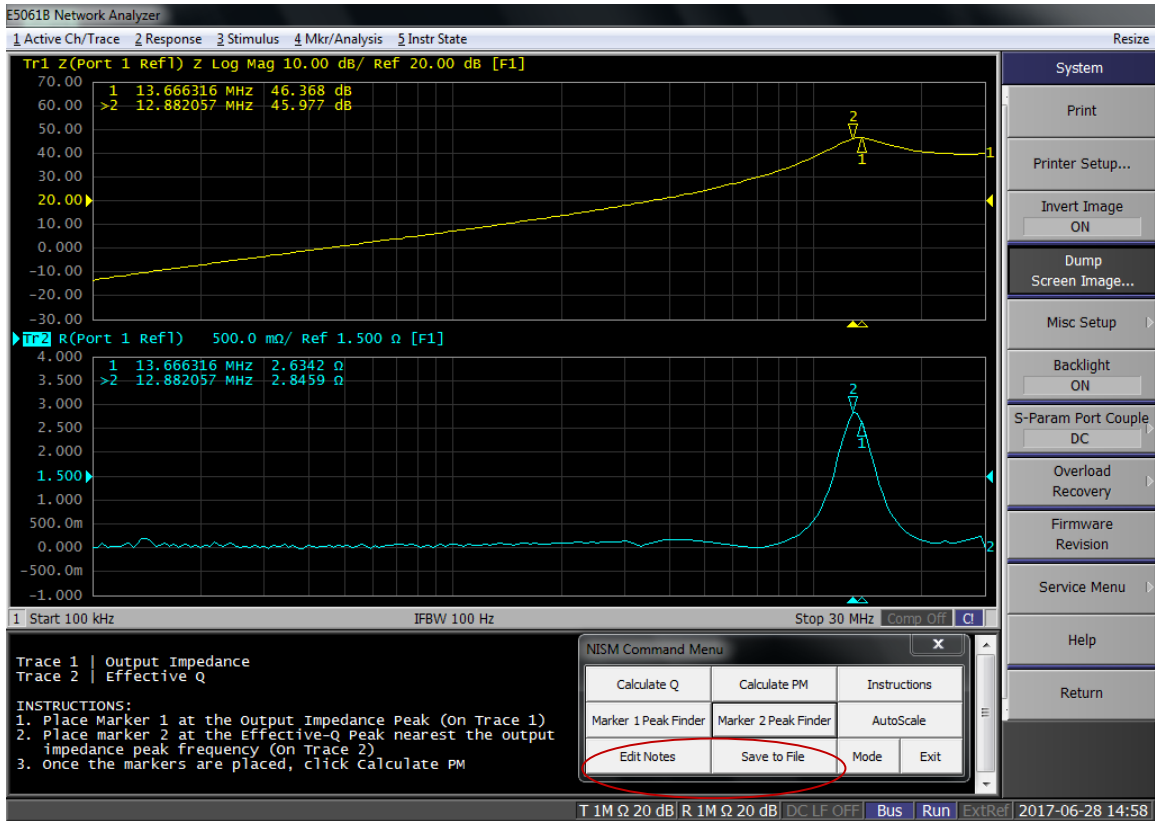

Figure 23: Step 6. Position marker one on trace 1 and marker 2 on trace 2 as detailed in the instructions at the bottom of the screen.

7. Click the “Calculate PM” button. The phase margin will be displayed at the bottom of the instruction window. You may move the markers and click the Calculate button repeatedly to update the Phase Margin computation.

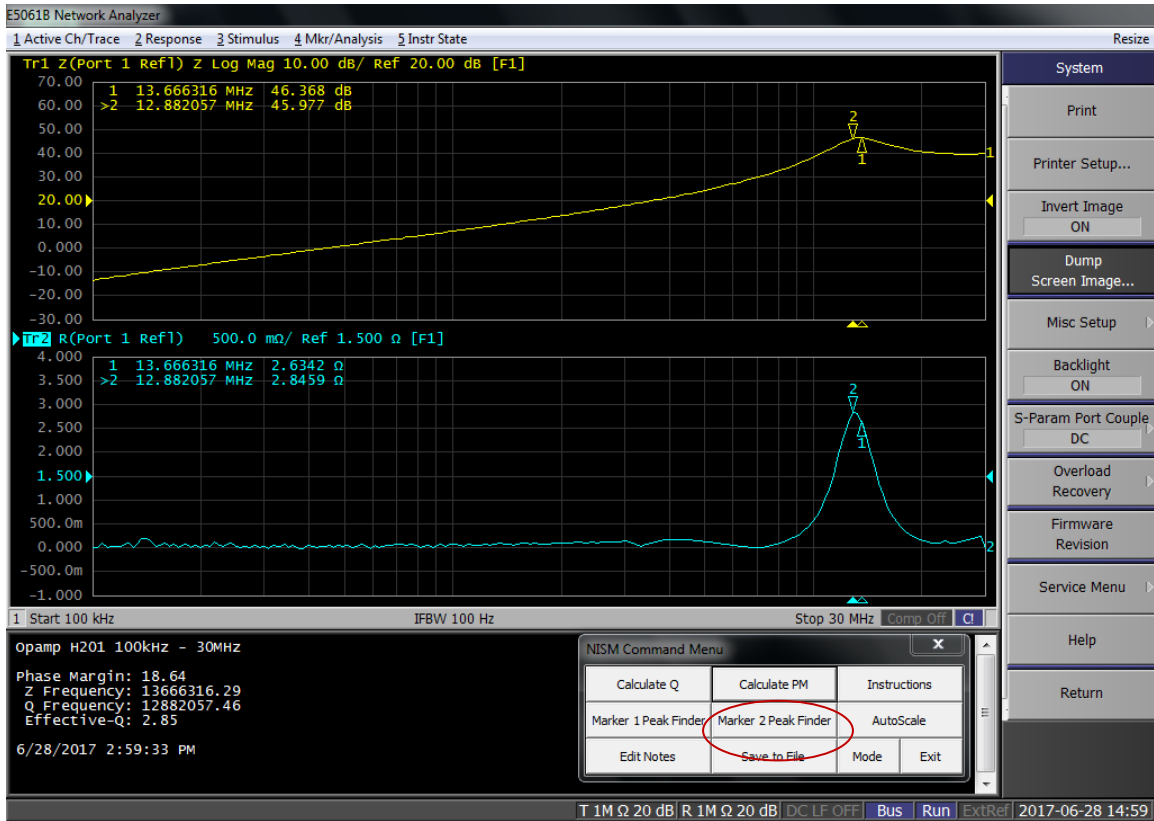

Figure 24: Step 7. After positioning the markers, click the “Calculate PM” button. The phase margin will be displayed at the bottom of the instruction window.

Note: if you change settings or re-measure the output impedance, you will need to click the Initial Setup button to re-compute the Effective Q waveform.

See the section on Saving Data or the native E5061B print data file dialogs to save your measurement results.

This concludes Example 2.

Example 3– 1-Port Measurement

In this example for the R&S ZNL, we will assess the stability of a high frequency opamp using only the opamp’s output impedance. Referring to the VRTS3 manual (<https://www.picotest.com/downloads/VRTS03/VRTS3-User-Guide.pdf>) we will measure S11 at H201 S201 on the Picotest VSRT3 Demo board.

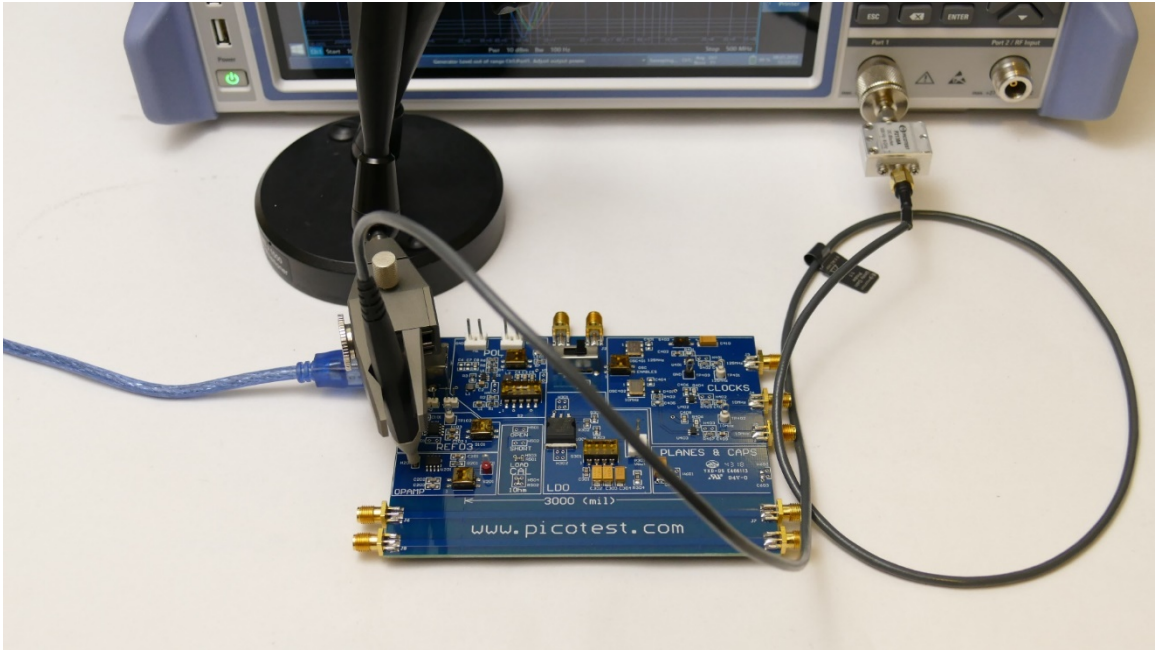

Figure 25: Test setup for a 1-port impedance measurement using a Picotest P2100A 1-Port 50 ohm Transmission Line PDN Probe and the Picotest P2130A DC block.

Note: Using a 1-Port 50Ohm probe and a DC blocker allows measurements greater than about 100milliOhms.

The steps are as follows:

1. Connect the 1-port probe and DC block to Port 1
2. Perform the SOL calibration using the calibrator on the VRTS3 board.
3. Select Start->Run->Non-Invasive Stability on the ZNL to run the NISM software
4. Select Z11 and make the measurement
5. Click Data->Mem in the NISM dialog
6. Click Calculate Q in the NISM dialog
7. Place markers on the impedance and $Q(T_g)$ peaks
8. Click Calc Phase Margin

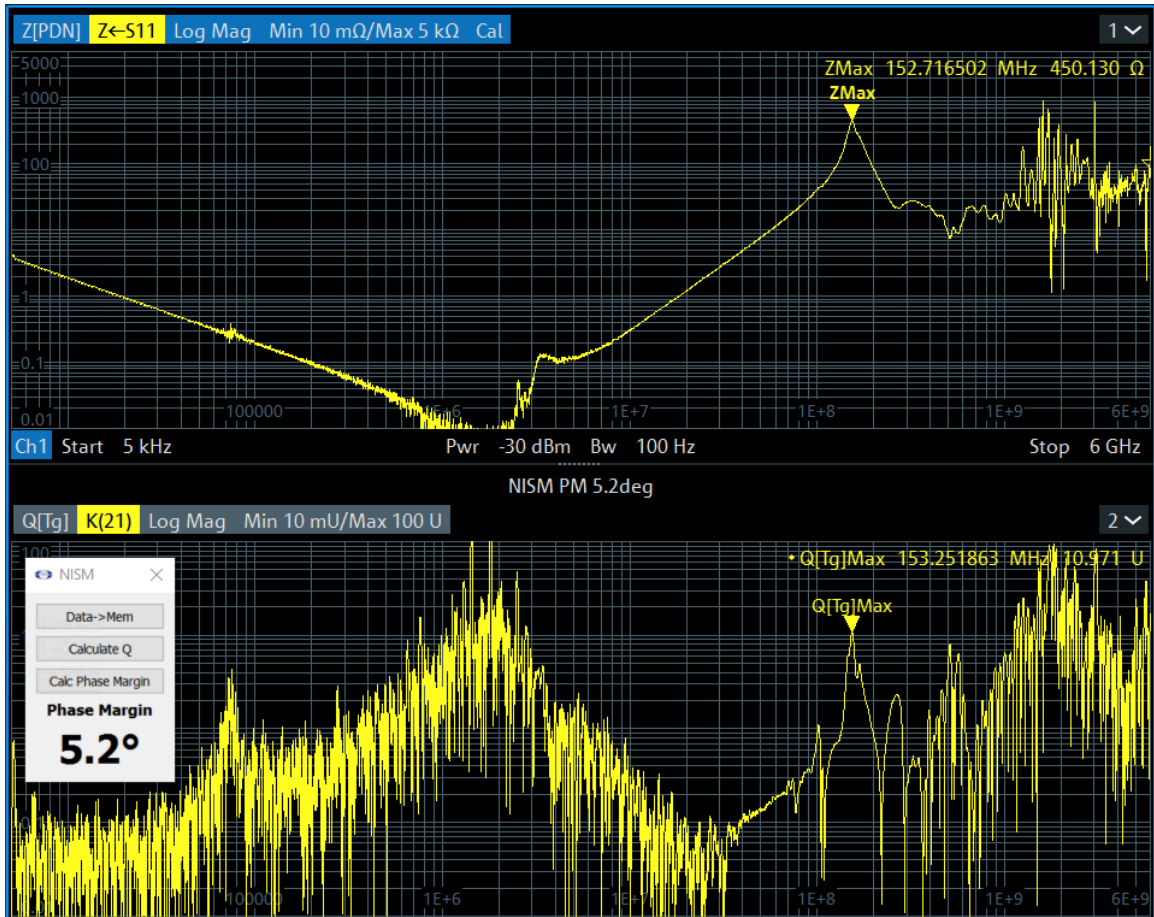

Figure 26: VRTS3 Opamp - 1-Port S11 measurement at H201 S201-On-Off shows the opamp's phase margin to be 5.2 degrees.

Example 3— 2-Port Shunt-Through Measurement

In this example for the R&S ZNL, we will assess the stability of an LDO using only the LDO's output impedance. Referring to the VRTS3 manual (<https://www.picotest.com/downloads/VRTS03/VRTS3-User-Guide.pdf>) we will measure S21 at H301 on the Picotest VSRT3 Demo board.

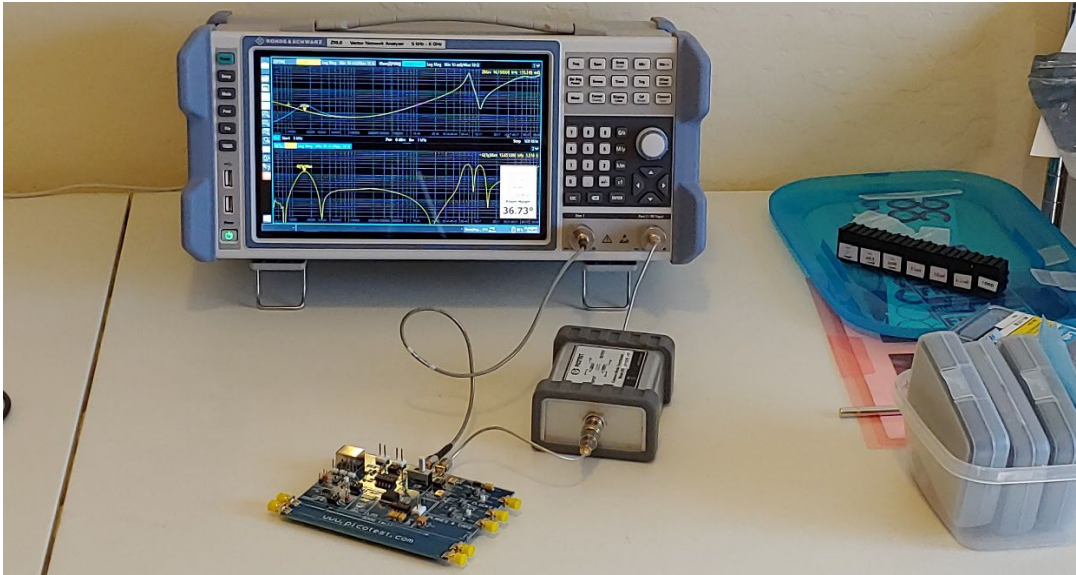

Figure 27: Test setup for a 2-port shunt-through impedance measurement using a Picotest J2102B coaxial transformer ground loop breaker. The SMA cables connect to the output of the LDO on the VRTS3 board.

The steps are as follows:

1. Connect 2 50 ohm SMA cables to the VRTS3 board and the ZNL. Through Port 2 connect the Picotest J2102B group loop breaker.
2. Perform a thru calibration.
3. Select Start->Run->Non-Invasive Stability on the ZNL to run the NISM software
4. Select Z21 and make the measurement
5. Click Data->Mem in the NISM dialog
6. Click Calculate Q in the NISM dialog
7. Place markers on the impedance and $Q(Tg)$ peaks
8. Click Calc Phase Margin

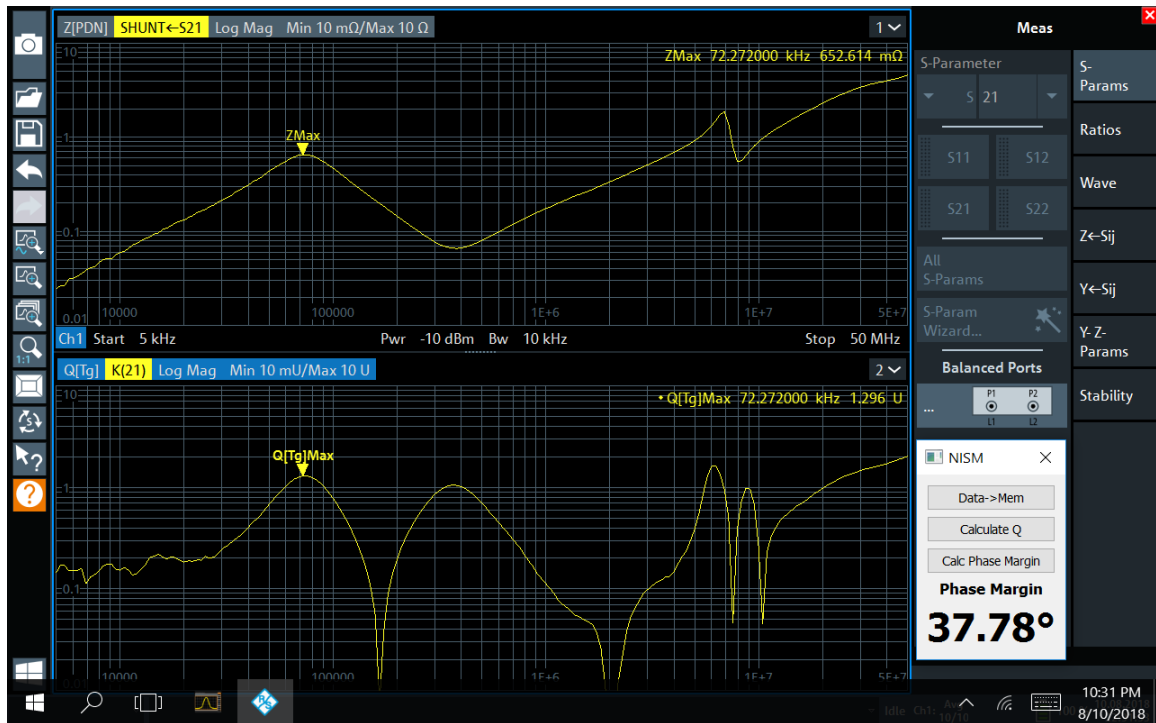

Figure 28: VRTS3 LDO - Shunt-S21 at H301 S301-On-Off-Off-Off PM 37.78 shows the LDOs phase margin to be 37.78 degrees. This is slightly different from the picture above due to different output capacitance settings (the VTRS3 allows the LDO to be tested using a variety of output capacitors).